



# **MEGAMAT XS**

## **Installation Instructions**

**(Translation of the original installation instructions)**



# Foreword

## Document revision history

Version	Date	Modification, change
(-)	03/12	First release
(a)	07/12	Edition II
(b)	12/12	RoHS
4.0	09/2019	Installation, ratings plate, declaration of conformity and installation

## Disclaimer and exclusion of liability

DewertOkin is not responsible for damage resulting from:

- failure to observe these instructions,
- changes made to this product which have not been approved by DewertOkin, or
- the use of replacement parts which have not been approved or manufactured by DewertOkin.

## Manufacturer's address

DewertOkin GmbH  
 Weststrasse 1  
 32278 Kirchlengern, Germany  
 Germany  
 Tel: +49 (0)5223/979-0  
 Fax.: +49 (0)5223/75182  
<http://www.dewertokin.de>  
[Info@dewertokin.de](mailto:Info@dewertokin.de)

## Creation of a complete operating instruction manual for the entire end product

These instructions are only intended to be used by the end-product manufacturer. They should not be given to the operator of the end product. The factual information contained within may be used as a basis when creating the end-product manual.

The warning and danger notices are best suited for use in the end product's manual. However it is not sufficient to simply follow these notices. You should also carry out an internal risk assessment for your end product. This can then be used as the basis for the safety notices in your manual.

These installation instructions do not contain all information required to safely operate the end product. They only describe the installation and operation of the drive as partially completed machinery.

The instructions are intended for the technicians responsible for manufacturing an end product and not for the operators of the end product.

## Notice for customers in EU nations

### German Inspection Authority (TÜV SÜD Product Service) testing label

The construction of the MEGAMAT XS drive has been inspected by the German TÜV SÜD Product Service Inspection Authority. TÜV SÜD Product Service also monitors the production of the MEGAMAT XS. The official German TÜV SÜD Product Service certifies this construction inspection and production monitoring.



Figure 1 TÜV SÜD Product Service Safety Mark

# Table of Contents

<b>Foreword</b>	<b>3</b>
Document revision history	3
Disclaimer and exclusion of liability	3
Manufacturer's address	3
Creation of a complete operating instruction manual for the entire end product	3
Notice for customers in EU nations	4
<b>Table of Contents</b>	<b>5</b>
<b>1. General Information</b>	<b>7</b>
1.1 About these installation instructions	7
1.2 Availability of this document	7
1.3 Conventions used	8
<b>2. Safety notices</b>	<b>9</b>
2.1 Proper and intended usage	9
2.2 Safety notices within the installation instruction and the operating instructions for the entire machine	10
2.3 Selection and qualification of personnel	10
2.4 Notice on safety during operations	10
2.5 Product identification	11
<b>3. Possible combinations</b>	<b>12</b>
<b>4. Description</b>	<b>13</b>
4.1 Components	13
<b>5. Technical specifications</b>	<b>15</b>
<b>6. Installation</b>	<b>17</b>
6.1 Safety notices to observe during installation	17
6.2 Installation procedure	18
<b>7. Operating notes</b>	<b>22</b>
7.1 General information	22
7.2 Notice for operating with optional configuration	23
<b>8. Troubleshooting</b>	<b>24</b>
<b>9. Maintenance</b>	<b>25</b>
9.1 Maintenance	25
9.2 Cleaning and care	25
<b>73115 4.0</b>	<b>5</b>



<b>10.</b>	<b>Disposal</b>	<b>26</b>
<b>10.1</b>	<b>Packaging material</b>	<b>26</b>
<b>10.2</b>	<b>Drive components</b>	<b>26</b>
	<b>Declaration of incorporation/installation</b>	<b>27</b>
	<b>EU Declaration of Conformity</b>	<b>28</b>
	<b>Additional information</b>	<b>29</b>

# 1. General Information

## 1.1 About these installation instructions

These installation instructions must be followed closely in order to install this drive successfully and safely in the end product. These instructions are not an operating manual for the end product.

These instructions will help you to minimize danger, repair costs and down times. They will also help you to maximize the reliability and lifespan of the end product.

	 <b>CAUTION</b>
	<p>The notices in these instructions must be followed! Following the guidelines during installation and connection procedures will help to minimize:</p> <ul style="list-style-type: none"><li>• the risk of accident and injury, and</li><li>• damage to the drive system or the end product.</li></ul>

These installation instructions have been written with due care and attention. However, we cannot guarantee that the data, images and drawings are complete and correct nor do we accept any liability for the information contained therein, unless required by law.

- ▶ We reserve the right to make unannounced technical changes in the course of our continual product improvement process!

## 1.2 Availability of this document



As manufacturer of the end product, you are obligated to comply with Machinery Directive 2006/42/EC. This directive stipulates that the installation instructions must be kept on file for governmental inspection purposes.



### 1.3 Conventions used

Notices which do not relate to safety are indicated in these instructions with a triangle:

- ▶ Triangular notice symbol

#### Safety notice explanations

	 <b>WARNING</b>
	WARNING indicates a hazardous situation which, if not avoided, <i>could</i> result in death or serious injury.

	 <b>CAUTION</b>
	CAUTION indicates a hazardous situation which, if not avoided, could result in minor or moderate injury.

	<b>NOTICE</b>
	NOTICE is used to address practices which are not related to personal injury but may result in damage to the product or surroundings.





## 2. Safety notices

### 2.1 Proper and intended usage



The MEGAMAT XS drive is meant to be installed in an end product.



- It provides motor adjustment capabilities for movable reclining bed parts. It should be used in conjunction with suitable fittings and mechanics:
- It can be used for care purposes (CARE).
- It can be used in a hospital (HOSP).

 <b>CAUTION</b>
 <p>This drive should only be used for the applications described above. Any other use is forbidden. Improper usage can lead to accidents or destruction of the unit. Such non-approved applications will lead immediately to the expiration of all guarantee and warranty claims on the part of the end-product manufacturer against the manufacturer.</p>



#### Improper usage

Be sure to follow the notices below concerning improper usage. You should include them in your product manual in order to inform the users of your end product.

 <b>WARNING</b>
 <p>The MEGAMAT XS drive should not be used:</p> <ul style="list-style-type: none"> <li>• in any environment where combustible or explosive gases or vapours (e.g., anaesthesiology) may be present,</li> <li>• with pulling or pushing forces that exceed those specified on the ratings plate,</li> <li>• in a moist environment,</li> <li>• outdoors,</li> <li>• in any application that will be cleaned with an automated washing system.</li> </ul>

 <b>CAUTION</b>
 <p>The MEGAMAT XS drive may not be operated:</p> <ul style="list-style-type: none"> <li>• by small children,</li> <li>• by frail or infirm persons without supervision, or</li> <li>• in the proximity of small children.</li> </ul>

The MEGAMAT XS drive can be used by children of 8 years and older, persons with reduced physical, sensory or mental capabilities, or persons with lack of experience or knowledge when they are supervised or instructed concerning the safe use of the device and when they understand the resulting risks. Do not allow children to play with this device. The cleaning and user maintenance must not be carried out by children without supervision.

 <b>CAUTION</b>
 <p>You should only use spare parts which have been manufactured or approved by DewertOkin. Only these parts will guarantee a sufficient level of safety.</p>

## 2.2 Safety notices within the installation instruction and the operating instructions for the entire machine

The manufacturer of the end product is only permitted to operate the MEGAMAT XS drive (by itself an incomplete machine)

- when the end product (for which the MEGAMAT XS drive is intended) is in compliance with all protective measures specified in the Machinery Directive 2006/42/EC, and
- when the manufacturer expressly declares the compliance of the end product.

The manufacturer of the end product must create a manual for the users of that product. The safety notices in the end-product manual must be written based on the end product's risk assessment.

## 2.3 Selection and qualification of personnel

This drive should only be installed into the end product by someone who has completed training in electronic motor assembly or has equivalent qualifications.

You should only install this drive when you are qualified to do so. Otherwise, a properly qualified person should be found for this task.

## 2.4 Notice on safety during operations

Basic safety rules must be followed in order to ensure that the end product can be continually operated in a safe manner. These rules must be observed while using the end product and while installing the drive.

These rules and safety measures can be categorized as follows:

- Construction measures before the installation (refer to the "Ensuring operational reliability during installation" section in Chapter "Installation").
- Safety fundamentals during the drive installation and during cable and wire routing (refer to the "Safety notices to observe during installation" section in the "Installation" Chapter).
- Using the drive in intermittent duty (refer to the "General information" section in the "Operating notes" chapter).
- Basic safety rules during operation (refer to the "Operating notes" Chapter).
- The creation of a manual for the end product which contains these and other safety rules.

### Creating a user's manual

The manufacturer of the end product must create a manual for the users of that product. The safety notices in the end-product manual must be written based on the end product's risk assessment.

## 2.5 Product identification

### 2.5.1 Ratings plate

A ratings plate on each drive specifies the exact name and serial number of the drive. It also states the technical specifications valid for that particular drive. The following illustration shows where the specifications are located on the drive's ratings plate.

- The ratings plate shown is an example; the specifications for your drive may differ from this illustration.

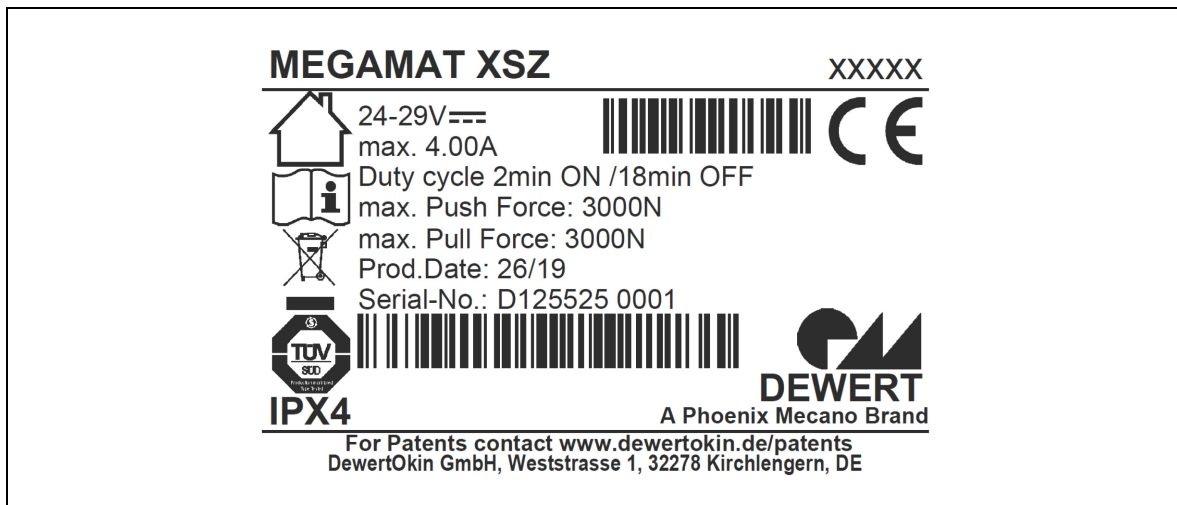

Figure 2 Ratings plate example

MEGAMAT XSZ	Model name
xxxxx	Article number
24 – 29V	Input voltage
Max. 4.00A	Current consumption
Duty cycle: 2 min ON / 18 min OFF	Intermittent operations: 2 minutes / 18 minutes
max. Push Force	Push force
max. Pull Force	Pull force
Prod.date	Calendar week / year
Serial No.	Serial number for your drive
IPX4	Protection degree
	Use in dry rooms only!
	Follow all special disposal instructions!
	Mark of CE conformity

### 3. Possible combinations

The MEGAMAT XS single drive can be combined for use with other single drives, double drives or control units. The following basic combinations are possible:

- a MEGAMAT XS with handset and control unit,
- the MEGAMAT XS in combination with other drives with an additional control unit or double drive.

Systems can be customized by combining drives with the handset and control units as needed. Make sure that you switch off the electricity before connecting any components (connect while in a voltage-free state).

DewertOkin has separate system instruction manuals containing all information and instructions needed for these systems.

- ▶ Only a DewertOkin device should be used to control the drive since they have already been verified to work together.
- ▶ A control unit or a double drive is needed to operate the MEGAMAT XS single drive. A handset is also required.



#### NOTICE

Check with DewertOkin for approval concerning any special device configurations that are customized for your requirements.

## 4. Description

The MEGAMAT XS drive is an electrically driven motor that is responsible for moving the end product in a linear direction. This adjustment is created by the in and out movement of a stroke pipe. The movements of the MEGAMAT XS drive are controlled using a control unit or a double drive which is connected to a DewertOkin handset.

The different drive models vary according to their:

- output performance,
  - the mounting of the stroke pipe.
- We reserve the right to make unannounced technical changes in the course of our continual product improvement process!

### 4.1 Components

The main components of the MEGAMAT XS drive are the motor and the stroke pipe. The stroke pipe is protected by the drive housing when it is retracted. Mounting fixtures are located at the outer end of the stroke pipe and at the opposite end of the drive. They are used to mount the drive in the end product.

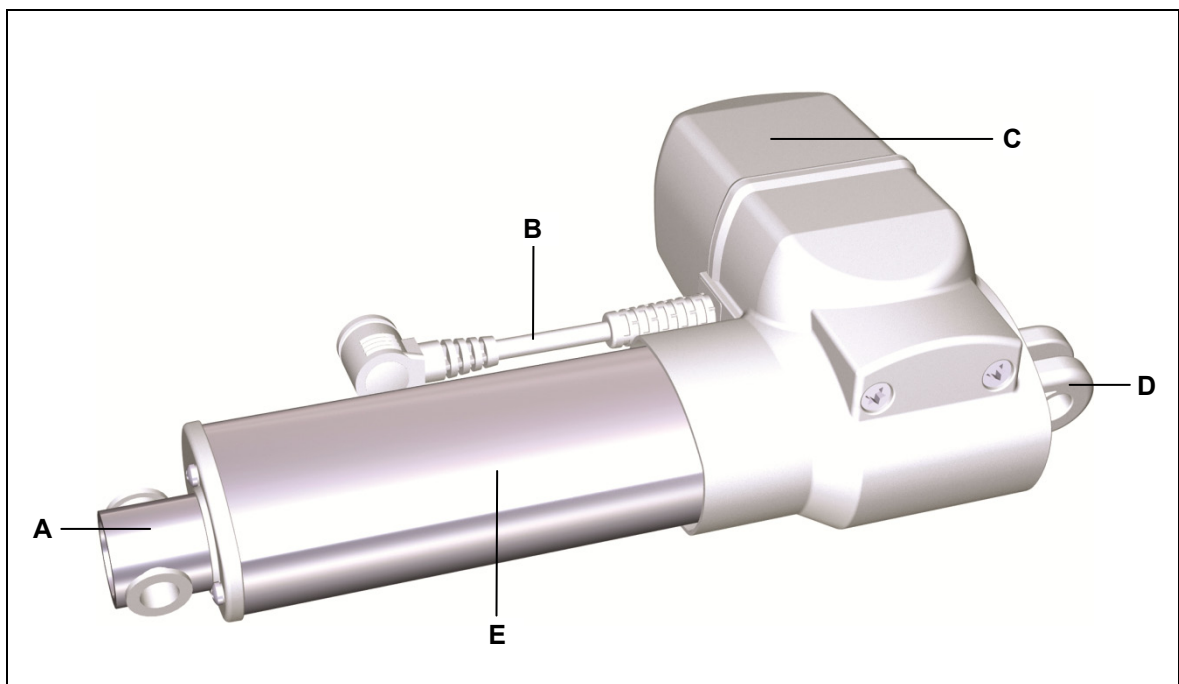

Figure 3 Main components of the drive MEGAMAT XS

- |                              |                                |
|------------------------------|--------------------------------|
| <b>A</b> Head of stroke pipe | <b>B</b> Electrical connection |
| <b>C</b> Motor housing       | <b>D</b> Gear clevis           |
| <b>E</b> Guidance profile    |                                |

#### 4.1.1 Stroke pipe options

There are two types of stroke pipes available for different types of applications. The stroke pipe can be screwed onto the spindle screw or it can be mounted unattached. The drive only exerts pushing force when the stroke pipe is mounted loosely (unattached). The motions of the drives for these two versions are shown in the following illustrations.

<b>⚠ CAUTION</b>	
<b>⚠</b>	If the stroke pipe is unattached, then the end product must be designed to prevent the stroke pipe from coming out during operations. This can be accomplished by implementing a fixed end-stop mechanism (refer to the "Safety notices to observe during installation" in the "Installation" chapter).

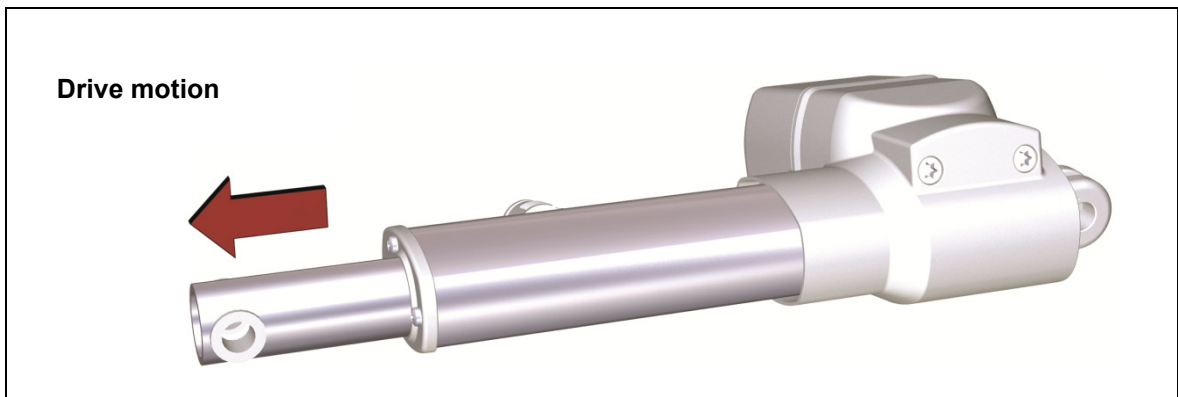

Figure 4 Loose fastening nut (stroke pipe not secured): only pushing forces

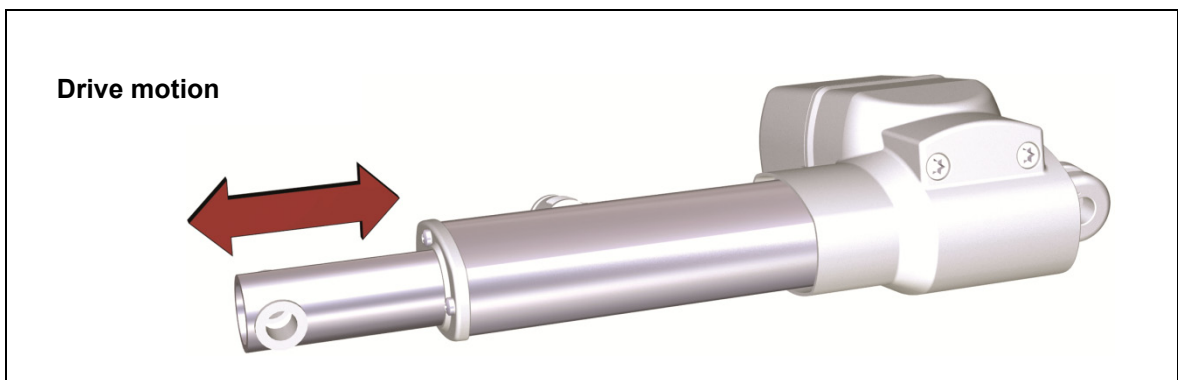

Figure 5 Stroke pipe screwed onto the spindle screw (attached): both pushing and pulling forces

## 5. Technical specifications

Input voltage	24 V DC – 29 V DC
Current consumption at rated load	Max. 4.0 A, depending on version (refer to the ratings plate on the drive)
Permitted push force	Max. 3000 N, depending on version (refer to the ratings plate on the drive)
Permitted pull force	Max. 3000 N, depending on version (refer to the ratings plate on the drive)
Mode of operation <sup>1</sup> at max. rated load	Intermittent duty 2 minutes /18 minutes
Protection class <sup>2)</sup>	III
Noise level	≤ 65 dB(A)
Drive type	Single drive
Load type	Push / pull
Adjustment speed <sup>3)</sup>	Up to 30 mm/second, depending on the version
Protection degree	IPX4 / IPX6
Stroke	< 350 mm
Colours	Refer to sales brochure
<b>Dimensions and weight</b>	
Length x width x height	Min. 168 mm x 146 mm x 62 mm
Weight	Approx. 1.5 kg, depending on version
<b>Ambient conditions for operation, storage and transport</b>	
Transport / storage temperature	From -20 °C to +50 °C From -4 °F to +122 °F
Operating temperature	From +10 °C to +40 °C From +50 °F to +104 °F
Relative humidity	From 30% to 75%
Air pressure	From 800 hPa to 1060 hPa
Height	< 2000 m

- 1) Mode of operation: intermittent duty 2 min./18 min. This means that after the unit is operated with its rated load for up to two minutes it must then be paused for 18 minutes. The system can malfunction if this pause is not observed!
- 2) Safety extra-low voltage
- 3) Adjustment speed: the speed at which the clevis can move under no load (the speed varies depending on the load).

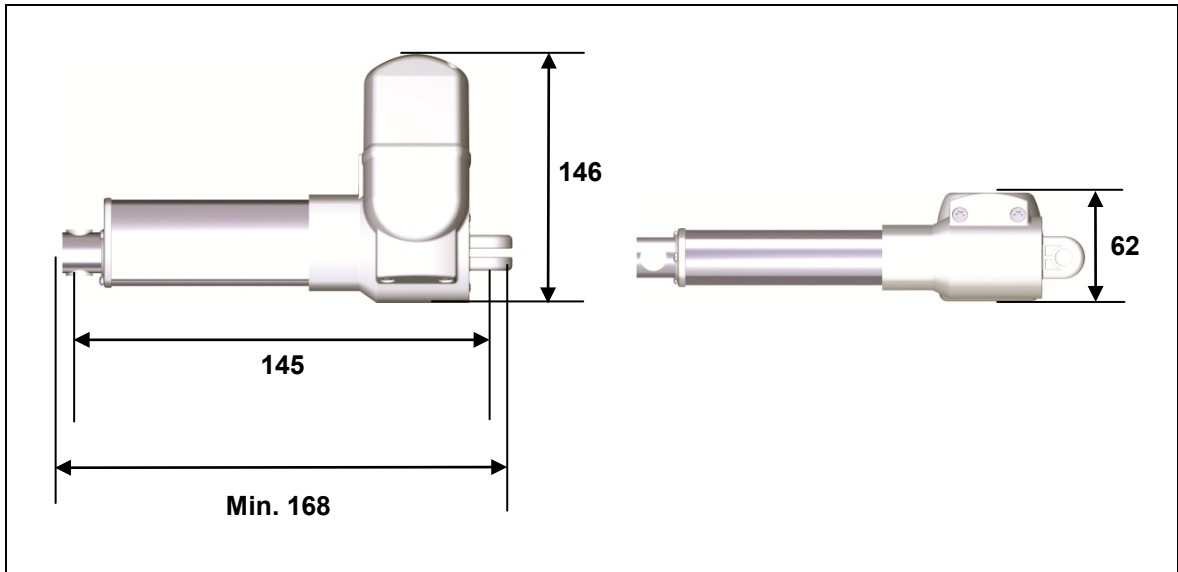

Figure 6 Dimensions of MEGAMAT XS drive (in mm), minimum installation dimension: 145 mm



## 6. Installation



### 6.1 Safety notices to observe during installation

Basic safety rules must be followed in order to ensure that the end product can be continually operated in a safe manner. These rules must be observed while using the end product and while installing the drive.



#### 6.1.1 Ensuring operational reliability during installation

The safety and reliability of the end product containing the DewertOkin drive can be ensured by using the proper construction methods described below.

##### Avoiding fatigue fractures



	 <b>CAUTION</b>
	<p>Drives that are incorrectly installed can undergo fatigue fractures which then create a risk of injury.</p> <ul style="list-style-type: none"> <li>• Install the drive in the end product so that it is properly aligned. This will help prevent shear stress.</li> <li>• Do not position the drive at a slanted angle when installing it in the end product. A slanted angle between the intended direction of movement of the end product and the drive's direction will create shear stress and could lead to a fatigue fracture.</li> <li>• Be sure to install the drive so that it can always move freely in all operative states.</li> <li>• You should never screw the stroke pipe into the drive.</li> </ul>

##### Avoiding a pinching hazard

	 <b>CAUTION</b>
	<p>When designing your product, you should take the drive adjustment movement into account with passive safety mechanisms and with the appropriate safety notices in your operating instructions.</p> <ul style="list-style-type: none"> <li>• Installation methods for ensuring passive safety: Install the MEGAMAT XS drive so that none of the positions where shear and pinch hazards exist are accessible externally.</li> </ul>

When preparing safety notices for the operator, Make sure that your operating instructions inform the user of these safety points.

### Avoiding an over-extension of the stroke pipe (when mounted unattached)

 <b>CAUTION</b>
 <p>There must be a fixed mechanical end stop built into the end product for MEGAMAT XS drive models where the stroke pipe is not attached to the spindle screw. If no fixed mechanical end stop exists, the stroke pipe can over-extend. This can cause malfunctions, personal injury, and damage to the drive system.</p>

### Avoiding an overrun of the stop point with the end product

Your end product should contain mechanical end stops. These will limit the drive movement and significantly increase operational safety. DewertOkin recommends that you build such mechanical end stops into your end product.

If, for technical or cost reasons, you choose not to use end stops, then we strongly recommend the use of an additional safety limit switch whenever the DewertOkin drive is being used for at-risk functions. A safety limit switch will protect the drive from a critical failure and overrun in the event that the top end switch malfunctions.

- ▶ The safety end switch shuts the drive down as soon as the normal end switch is passed over. The safety end switch is integrated directly into the drive and does not require any additional installation. The drive may take up an extra 23 mm when installed with the safety limit switch.

## 6.2 Installation procedure

<b>NOTICE</b>
<p>Mount the drive in its unloaded position within your end product.          The drive must either be completely retracted or extended at its end position.          Damage to the drive can <b>only</b> be avoided if the drive is installed in its unloaded position. This ensures safe installation.</p>

### 6.2.1 An installation example

Before installing the drive, make sure that you are observing all of the safety notices found in the "Safety notices to observe during installation" section.

	<b>CAUTION</b>
The mains power cable should be unplugged during the installation.	

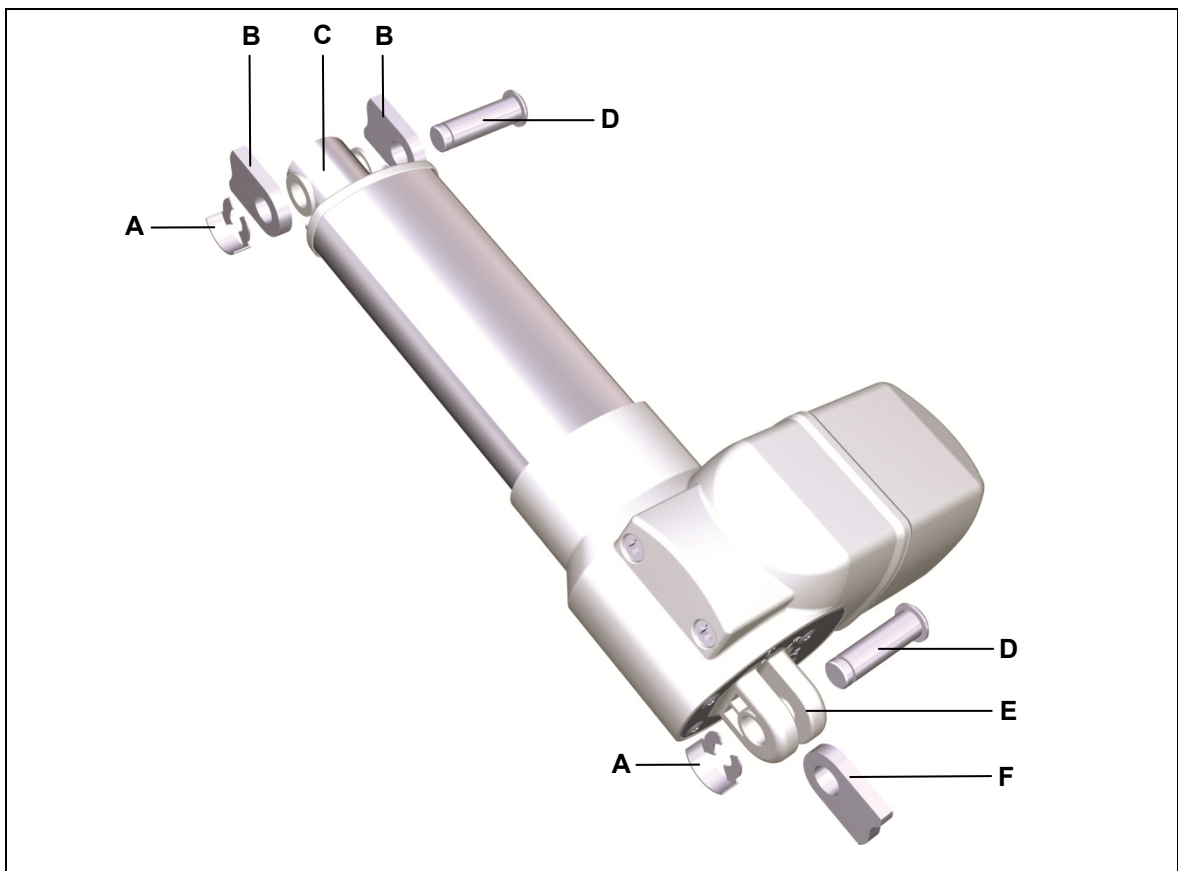



Figure 7 Installing the drive (example)



- |   |   |
|---|---|
| <p><b>A</b> Safety clip</p> <p><b>C</b> Head of stroke pipe</p> <p><b>E</b> Gear clevis</p> | <p><b>B</b> Bracket for securing the drive (on the stroke pipe side)</p> <p><b>D</b> Mounting bolt</p> <p><b>F</b> Bracket for securing the drive (on the motor side)</p> |
|---|---|

In the following example, installation of the MEGAMAT XS drive into the end product is shown using the mounting bolt.

- ▶ Certain details may change because of technical changes.
- 1 Move your product into a position where it is supporting no load.
- 2 Push the drive's gear clevis (**E**) onto the bracket (**F**).
- 3 Insert the mounting bolt (**D**) into the bracket (**F**).
- 4 Secure the mounting bolt (**D**) with the safety clip (**A**).



	 <b>CAUTION</b>
	<p>You should never screw the stroke pipe into the drive. A stroke pipe that has been screwed into the drive can result in fatigue fractures.</p>



- 5 If the stroke pipe clevis (**C**) does not align exactly with the gear clevis (**E**), the stroke pipe may be unscrewed out of the drive by no more than a half turn.

	 <b>CAUTION</b>
	<p>The stroke pipe may only be turned one half rotation out of the drive. Do not rotate the stroke pipe further out. An over-rotation can lead to unsafe operations.</p>

- 6 Attach the stroke pipe (**C**) using a mounting bolt (**D**) to the fitting (**B**).
  - 7 Secure the mounting bolt (**D**) with the safety clip (**A**).
  - 8 Now connect the drive to the control unit or the double drive. Ensure that the electrical connection cable cannot be pulled out.
- If the hand switch will be used to control two drives, you must first connect both drives electrically to each other (for example, over a control unit). Then you can connect the handset.

**6.2.2 Electrical connection**

	 <b>CAUTION</b>
	<p>Electrical components should be connected or disconnected only when the mains power cord and the battery plug (when present) are unplugged.</p>

	 <b>WARNING</b>
	<p>Only the following personnel are qualified to work on the power cord or to replace the power cord:</p> <ul style="list-style-type: none"> <li>• someone who has completed training in electronic motor assembly,</li> <li>• someone with equivalent qualifications, or</li> <li>• someone who has successfully completed the appropriate DewertOkin training program.</li> </ul> <p>You should only work on the power cord when you are qualified to do so. Otherwise, a properly qualified person should be found for this task.</p>

	<b>NOTICE</b>
	<p>There is a delay after the supply voltage is applied before the device actually turns on. Wait at least 15 seconds before initial commissioning.</p>



### Routing the electrical cables

When routing the cables, be sure that:

- the cables cannot get jammed,
- no mechanical load (such as pulling, pushing or bending) will be put on the cables, and
- the cables cannot be damaged in any way.



Fasten all cables (especially the mains cable) to the end product using sufficient strain relief and kink prevention methods. Be sure that the design of the end product prevents the mains cable from coming into contact with the floor during transport.

### 6.2.3 Dismantling

	 <b>CAUTION</b>
	Electrical components should be connected or disconnected only when the mains power cord and the battery plug (when present) are unplugged.

► Certain details may change because of technical changes.

- 1 Move your product into a position where it is supporting no load.

	 <b>CAUTION</b>
	Be sure to carry out work on the drive in a position so that no loads are bearing on it. Only in this way can you be sure to avoid any risks of crushing or injury.



- 2 Unplug the mains power plug and the battery plug (when present)!
- 3 If multiple drives are connected electrically, they should be disconnected from each other.
- 4 Disconnect the drive from the control unit or double drive.

	<b>NOTICE</b>
	Be sure to support the drive's weight while you are loosening the bolt.

- 5 Remove the security clips and the mounting bolt.

## 7. Operating notes

The factual information contained within may be used when you are creating the end-product manual. The installation instructions do not contain all information required for the safe operation of the end product. They only describe the installation and operation of the drive as a partially assembled piece of machinery.

	 <b>CAUTION</b>
	When creating the operating instructions, remember that the installation instructions are intended for qualified specialists and are not for typical users of the end product.

### 7.1 General information



- ▶ Only a DewertOkin device should be used to control the drive since they have already been verified to work together.

#### Power-on time / intermittent operations



The MEGAMAT XS drive has been designed for intermittent operations. Intermittent operation is an operational mode where the drive must pause after a specified maximum period of operation (power-on time). This protects the drive from overheating. Extreme overheating can cause a malfunction.

- ▶ The ratings plate specifies the maximum power-on time and the required pause intervals.

#### Avoiding electrical risks



	 <b>WARNING</b>
	Make sure that all live (current-carrying) parts of the drive system and power supply cannot be touched. In particular, be sure that unused power and control unit connections are covered adequately.

#### Shutting off the drive

	 <b>CAUTION</b>
	In order to shut off the drive, unplug the mains power plug and the battery plug (when present)! The power plug must always be accessible during operations so that emergency shut-off is possible.



#### Avoiding cable damage



Be sure that your operating instructions inform the user about the possible cable risks.

	 <b>CAUTION</b>
	The cables (particularly the mains cable) should not be run over. In order to prevent injuries or drive damage, no mechanical strain should be placed on the cables.

## 7.2 Notice for operating with optional configuration



### 7.2.1 Configuration: Attached nut

	 <b>CAUTION</b>
	You should never screw the stroke pipe into the drive. A stroke pipe that has been screwed into the drive can result in fatigue fractures.

	 <b>CAUTION</b>
	The stroke pipe may only be turned one half rotation out of the drive. Do not rotate the stroke pipe further out. An over-rotation can lead to unsafe operations.

## 8. Troubleshooting

This chapter describes troubleshooting methods for fixing problems. If you experience an error that is not listed in this table, please contact your supplier.

	 <b>CAUTION</b>
	<p>Only qualified specialists who have received electrician training should carry out troubleshooting and repairs.</p>

Problem	Possible cause	Solution
The handset or drive system is not functioning.	There is no mains supply voltage.	Connect the mains power.
	The hand switch or drive system is defective.	Please contact your supplier or sales agent.
The drive is suddenly not capable of movement.	Possibly the thermal circuit breaker on the transformer has been triggered or is defective.	The drive system should be allowed to pause for 20 – 30 minutes.
	The thermal fuse on the transformer may have been triggered.	Please contact your supplier or sales agent.
	The unit's fuse may have been triggered or may be broken.	Please contact your supplier or sales agent.
	There is no mains supply voltage.	Connect the mains power.
	A lead-in connection has been interrupted (mains power, hand switch or auxiliary drive).	Check the lead-in connections and re-seat the contacts if required.



## 9. Maintenance

- ▶ You should only use spare parts which have been manufactured or approved by DewertOkin. Only these parts will guarantee a sufficient level of safety.

### 9.1 Maintenance

Type of check	Explanation	Time interval
Check the function and safety of the electrical system.	A qualified electrician should carry out this inspection. (Refer to the "Electrical connection" section in the "Installation" Chapter.)	Periodic inspections can be carried out at intervals based on the risk assessment which you conduct for your end product.
Periodic visual inspection for housing damage.	Check the housing for breaks or cracks. The IP-class protection will be impaired by any breakage or cracks.	At least every six months.
Periodic visual inspection of the plug-in connections and electrical access points for damage.	Check that all electrical cables and connections are firmly seated and correctly positioned.	At least every six months.
Periodic visual inspection for cable damage.	Check the connecting cables for pinching or shearing. Also check the strain relief and kink protection mechanisms, in particular after any mechanical load.	At least every six months.
Periodic functional test of the end switches.	Move the drive to the end positions in order to test the end switches.	At least every six months.

### 9.2 Cleaning and care

The MEGAMAT XS drive was designed so that it would be easy to clean. Its smooth surfaces simplify the cleaning process.

	<b>NOTICE</b>
	<p>Never clean the drive in an automated washing system or with a high-pressure cleaner. Do not allow fluids to penetrate the drive. Damage to the system could result.</p> <p>Do not use a cleanser that contains benzene, alcohol or similar solvents.</p>

- 1 Always disconnect the mains power plug of the control unit or double drive (and the battery plug if present) before you start to clean the unit!
- 2 Clean the MEGAMAT XS drive with a moist cloth.
- 3 Make sure that you do not damage the drive's connecting cable.

## 10. Disposal

### 10.1 Packaging material

The packaging material should be sorted into recyclable components and then disposed of in accordance with the appropriate national environmental regulations (in Germany according to the recycling law KrWG from 01.06.2012; internationally according to the EU Directive 2008/98/EC (Waste Framework Directive WFD as of 12.12.2008)).

### 10.2 Drive components

The MEGAMAT XS drive consists of electronic components, cables and metal and plastic parts. You should observe all corresponding national and regional environmental regulations when disposing of the MEGAMAT XS drive.

The disposal of the product is regulated in Germany by Elektro-G, internationally by the EU Directive 2012/19/EC (WEEE), or by any applicable national laws and regulations.



The MEGAMAT XS drive should not be disposed of with normal household waste!

## Einbauerklärung

nach Anhang II der EU-Maschinenrichtlinie  
2006/42/EG

Der Hersteller

## Declaration of Incorporation

*According to Appendix II of the EU Machinery  
Directive 2006/42/EC*

*The manufacturer:*

DewertOkin GmbH  
Weststraße 1  
32278 Kirchlengern  
Deutschland - Germany

erklärt hiermit, dass nachstehend beschriebene  
unvollständigen Maschinen

*declares that the incomplete machines described  
below*

### **MEGAMAT XSZ MEGAMAT XS(n)<sup>1)</sup>**

die folgenden grundlegenden Anforderungen der  
Richtlinie Maschinen (2006/42/EG) erfüllt:

*complies with the following basic requirements of the  
Machinery Directive (2006/42/EC):*

Abschnitt:

*Sections:*

1.1.3; 1.3.3; 1.3.4; 1.3.7; 1.5.1; 1.5.2; 1.5.5; 1.5.6; 1.5.7; 1.5.8; 1.5.9; 1.5.10; 1.5.13

Die unvollständige Maschine darf erst dann in Be-  
trieb genommen werden, wenn festgestellt wurde,  
dass die Maschine, in die die unvollständige Ma-  
schine eingebaut werden soll, den Bestimmungen  
der Richtlinie Maschinen (2006/42/EG) entspricht.

*You may only operate this incomplete machine after  
you have confirmed that the end product (into which  
this machine will be installed) complies with the  
Machinery Directive 2006/42/EC.*

Der Hersteller verpflichtet sich, die speziellen Unter-  
lagen zur unvollständigen Maschine einzelstaatli-  
chen Stellen auf begründetes Verlangen elektronisch  
zu übermitteln. Die zur Maschine gehörenden  
speziellen technischen Unterlagen nach Anhang VII  
Teil B wurden erstellt.

*On reasonable request, the manufacturer is obliged  
to send the special documentation accompanying the  
partially completed machinery in electronic form to  
the appropriate national institution. The special  
technical documents corresponding to the machine  
have been created according to Appendix VII, part B.*

Für die Zusammenstellung der technischen Unter-  
lagen ist bevollmächtigt: DewertOkin GmbH  
Weststraße 1  
32278 Kirchlengern  
Tel.: 05223 979-0  
Deutschland - Germany

*For preparation of the technical documentation is  
authorized: DewertOkin GmbH  
Weststraße 1  
32278 Kirchlengern  
Tel.: 05223 979-0  
Deutschland - Germany*



Kirchlengern, Germany 25 November 2019

Dr.-Ing. Josef G. Groß  
Geschäftsführer / Managing Director

<sup>1)</sup> (n) steht für/stands for 1 – 5

## EG-Konformitätserklärung

Nach Anhang IV der EMV-Richtlinie 2014/30/EU

Nach Anhang IV der EU-Niederspannungsrichtlinie 2014/35/EU

Nach Anhang VI der RoHS-Richtlinie 2011/65/EU (inkl. Delegierte Richtlinie (EU) 2015/863)

Der Hersteller

## EU Declaration of Conformity

*In compliance with Appendix IV of the EMC-Directive 2014/30/EU*

*In compliance with Appendix IV of the LVD-Directive 2014/35/EU*

*In compliance with Appendix VI of the EU RoHS Directive 2011/65/EU (incl. Commission delegated Directive (EU) 2015/863)*

*The manufacturer*

DewertOkin GmbH  
Weststraße 1  
32278 Kirchlegern  
Deutschland - Germany

erklärt hiermit, dass das Produkt

*declares that the following product*

### **MEGAMAT XSZ MEGAMAT XS(n)<sup>1)</sup>**

#### **mit DewertOkinSteuerung / with DewertOkin Control unit**

die Anforderungen folgender EG-Richtlinien erfüllt:

*meets the requirements of the following EU directives:*

**Richtlinie über elektromagnetische Verträglichkeit 2014/30/EU**

***Electromagnetic Compatibility Directive 2014/30/EU***

**Niederspannungsrichtlinie 2014/35/EU**

***Low Voltage Directive 2014/35/EU***

**DELEGIERTE RICHTLINIE (EU) 2015/863 DER KOMMISSION vom 31. März 2015 zur Änderung von Anhang II der Richtlinie 2011/65/EU des Europäischen Parlaments und des Rates hinsichtlich der Liste der Stoffe, die Beschränkungen unterliegen.**

***COMMISSION DELEGATED DIRECTIVE (EU) 2015/863 of 31 March 2015 amending Annex II to Directive 2011/65/EU of the European Parliament and of the Council as regards the list of restricted substances.***

Angewendete Normen

*Applied standards:*

- EN 60335-1:2012/A11:2014
- EN 55014-1:2006/A1:2009/A2:2011
- EN 55014-2:1997/A1:2001/A2:2008
- EN 61000-3-2:2014
- EN 61000-3-3:2013
- EN 62233:2008

Konstruktive Änderungen, die Auswirkungen auf die in der Montageanleitung angegebenen technischen Daten und den bestimmungsgemäßen Gebrauch haben, das Produkt also wesentlich verändern, machen diese Konformitätserklärung ungültig!

*This declaration of conformity is no longer valid if constructional changes are made which significantly change the drive system (i.e., which influence the technical specifications found in the instructions or the intended use)!*

Kirchlegern, Germany 25 November 2019



Dr.-Ing. Josef G. Groß  
Geschäftsführer / Managing Director

1) (n) steht für/stands for 1 – 5

## Additional information

### MEGAMAT XS drive system

The following standards and norms were used in the versions with at least IPX4 and higher in according to

- EN 60601-1:2006 + A1:2013, IEC 60601-1:2005 + A1:2012 (short description: Edition 3.1), Medical electrical equipment.
- EN 60601-1-2:2015, IEC 60601-2-2:2014 (short description: Edition 4.0), EMC

IEC/EN60601-1, Section 4	General requirements
IEC/EN60601-1, Section 6	Classification
IEC/EN60601-1, Section 7.1	Labelling – general
IEC/EN60601-1, Section 7.2	Labelling – inscriptions
IEC/EN60601-1, Abschnitt 8	Protection against electrical danger
IEC/EN60601-1, Section 11.1	Overheating protection
IEC/EN60601-1, Section 11.2	Fire prevention
IEC/EN60601-1, Section 11.3	Design requirements for fire-resistant housing
IEC/EN60601-1, Section 13	Dangerous situations and error conditions
IEC/EN60601-1, Section 16.6	Leakage current
IEC/EN60601-1, Section 17	Electromagnetic compatibility
IEC/EN60601-2-52, Section 201.11.6.5.101	Protection against water ingress: only applied for at least IPX4
IEC/EN60601-2-52, Section 201.9.8.3.2	Static load

DewertOkin GmbH  
Weststrasse 1  
Kirchlengern 32278, Germany  
Tel: +49 (0)5223/979-0  
Fax.: +49 (0)5223/75182  
<http://www.dewertokin.de>  
[Info@dewertokin.de](mailto:Info@dewertokin.de)

ID No.: 73115