



# Installation Instructions

CU155 HALOBOX



# Foreword

## Revisions

Version	Date	Changes
(-)	06/09	First edition
(a)	07/12	Second edition
(b)	12/12	RoHS

## Disclaimer and exclusion of liability

DewertOkin is not responsible for damage resulting from:

- failure to observe these instructions,
- changes made to this product which have not been approved by DewertOkin, or
- the use of replacement parts which have not been approved or manufactured by DewertOkin.

## Contact addresses

DewertOkin GmbH  
 Weststraße 1  
 32278 Kirchlengern  
 Germany  
 Tel: +49 (0)5223/979-0  
 Fax: +49 (0)5223/75182  
<http://www.dewertokin.de>  
[Info@dewertokin.de](mailto:Info@dewertokin.de)

## Creation of a complete operating instruction manual for the entire end product

These instructions are only intended to be used by the end-product manufacturer. They should not be given to the operator of the end product. The factual information contained within may be used as a basis when creating the end-product manual.

The warning and danger notices may be particularly suited for use in the end-product's manual. However it is not sufficient to simply follow these notices. You should also carry out an internal risk assessment for your end product. This can then be used as the basis for the safety notices in your manual.

## Trademark

QUICKON® is a registered trademark of Phoenix Contact GmbH & Co. KG.

# Table of Contents



<b>Foreword</b>	<b>3</b>
<b>Revisions</b>	<b>3</b>
<b>Disclaimer and exclusion of liability</b>	<b>3</b>
<b>Contact addresses</b>	<b>3</b>
<b>Creation of a complete operating instruction manual for the entire end product</b>	<b>3</b>
<b>Trademark</b>	<b>3</b>
<b>Table of Contents</b>	<b>4</b>
<b>1. General</b>	<b>5</b>
1.1 About these installation instructions	5
1.2 Conventions used	5
<b>2. Safety Notices</b>	<b>6</b>
2.1 Proper and intended usage	6
2.2 Selection and qualification of personnel	7
2.3 Notice on safety during operations	7
2.4 Product labelling	7
<b>3. Description of component</b>	<b>10</b>
3.1 Device components	10
<b>4. Technical Specifications</b>	<b>11</b>
4.1 CU155 HALOBOX	11
4.2 QUICKON <sup>®</sup> fast-connect plug	13
<b>5. Installation</b>	<b>14</b>
5.1 Safety notices to observe during installation	14
5.2 Installation procedure	14
<b>6. Notices for operation</b>	<b>22</b>
6.1 General notice	22
<b>7. Troubleshooting</b>	<b>23</b>
<b>8. Maintenance</b>	<b>24</b>
8.1 Maintenance	24
8.2 Cleaning and care	24
<b>9. Disposal</b>	<b>25</b>
<b>EU Declaration of conformity</b>	<b>26</b>

# 1. General

## 1.1 About these installation instructions

These installation instructions must be followed in order to install the CU155 HALOBOX successfully and safely in the end product. These instructions are not an operating manual for the end product.

These instructions will help you to minimize danger, repair costs and down times. They will also help you to maximize the reliability and lifespan of the end product.

	 <b>CAUTION</b>
	<p>The notices in these instructions must be followed! Their observance during installation and connection will help to minimize</p> <ul style="list-style-type: none"> <li>• the risk of accident and injury, and</li> <li>• damage to the CU155 HALOBOX or the end product.</li> </ul>

These installation instructions have been written with due care and attention. However, unless otherwise required by law, we do not guarantee that the data, images and drawings are accurate or complete nor do we accept liability for their contents.



- ▶ We reserve the right to make unannounced technical changes in the course of our continual product improvement process!



## 1.2 Conventions used



Notices which do not relate to safety are indicated in these instructions with a triangular symbol:

- ▶ Notice symbol

### Explanations of warning notices

	 <b>DANGER</b>
	DANGER indicates a hazardous situation which, if not avoided, will result in serious injury or death.

	 <b>WARNING</b>
	WARNING indicates a hazardous situation which, if not avoided, could result in serious injury or death.

	 <b>CAUTION</b>
	CAUTION indicates a hazardous situation which, if not avoided, could result in minor or moderate injury.



	<b>NOTICE</b>
	NOTICE is used to address practices which are not related to personal injury but may result in damage to the product or surroundings.

## 2. Safety Notices

### 2.1 Proper and intended usage



The CU155 HALOBOX is intended to be installed in an end product. It can be used as follows:



- for connecting a drive to provide motor adjustment capabilities for movable furniture and hospital beds,
- for connecting a drive control unit,
- for connecting one or two halogen lamps with DIN 41529 plugs (for example, for reading lamps or lighting under the bed).



	 <b>CAUTION</b>
	<p>This CU155 HALOBOX should only be used for the applications described above. Any other application is not permitted and can lead to accidents or damage to the unit. Such non-approved applications will lead immediately to the expiration of all guarantee and warranty claims on the part of the end-product manufacturer against DewertOkin.</p>

#### 2.1.1 Improper usage

Be sure to follow the notices below concerning improper usage. You should include them in your product manual in order to inform your end product users.

	 <b>WARNING</b>
	<p>The CU155 HALOBOX should not be used:</p> <ul style="list-style-type: none"> <li>• in any environment where combustible or explosive gases or vapours (e.g., anaesthesiology) may be present,</li> <li>• in a moist environment, or</li> <li>• outdoors.</li> </ul>

	 <b>CAUTION</b>
	<p>The CU155 HALOBOX may not be operated:</p> <ul style="list-style-type: none"> <li>• by small children,</li> <li>• by frail or infirmed persons without supervision, or</li> <li>• in the proximity of small children.</li> </ul>

	 <b>CAUTION</b>
	<p>You should only use spare parts which have been manufactured or approved by DewertOkin. Only these parts will guarantee a sufficient level of safety.</p>

## 2.2 Selection and qualification of personnel

This CU155 HALOBOX should only be installed into the end product by someone who has completed training in electronic motor assembly or has equivalent qualifications.

You should only install the CU155 HALOBOX when you are qualified to do so. Otherwise, a properly qualified person should be found for this task.

## 2.3 Notice on safety during operations

Basic safety rules must be followed in order to ensure that the end product can be continually operated in a safe manner. These rules must be observed while using the end product and while installing the CU155 HALOBOX.

These rules and safety measures can be categorized as follows:

- construction measures before the installation (refer to the "Ensuring operational reliability during installation section in the chapter "Installation"),
- safety fundamentals during the CU155 HALOBOX installation and during cable and wire routing (refer to the "Electrical connection" section in the chapter "Installation"),
- basic safety rules during operation (refer to the chapter "Notices for operation"), and
- the creation of a manual for the end product which contains these and other safety rules.

### 2.3.1 Creating a user's manual

The manufacturer of the end product must create a manual for the user of that product. The safety notices in the end-product manual must be written based on the end product's risk assessment.

## 2.4 Product labelling

### 2.4.1 Type label

A rating plate (or type label) on each CU155 HALOBOX specifies the exact name and serial number of the drive. It also states the technical specifications valid for that particular CU155 HALOBOX. The following illustration shows where the specifications are located on the rating plate of the CU155 HALOBOX.

- ▶ The rating plate shown is an example; the specifications for your CU155 HALOBOX may differ from this illustration.

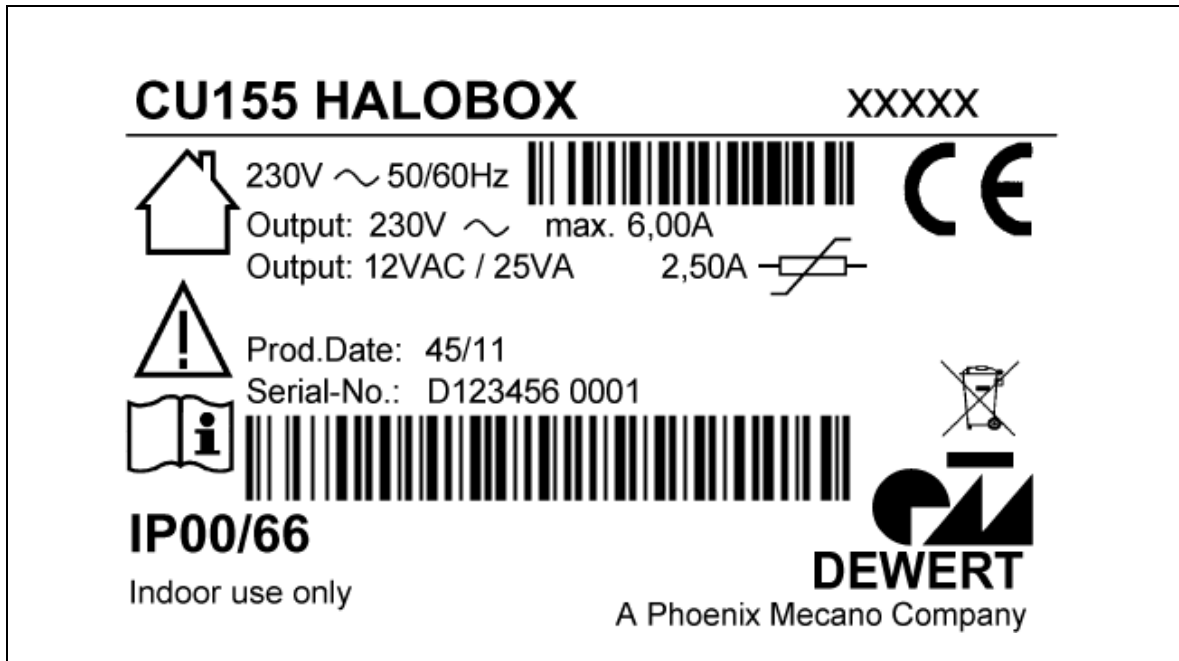







Figure 1 Rating plate for the CU155 HALOBOX (example)

CU155 HALOBOX	Model name
xxxxx	ID No.:
230 V ~ 50 / 60 Hz	Input voltage and frequency
Output: 230 V ~ max. 6.00 A	Output voltage and permissible output current
Output: 12 VAC / 25 VA	Output voltage (per lamp) / total output current
2.50 A 	Current for lamp fuse, self-resetting
Prod.Date	Calendar week / year
Serial-No.	Serial number for the CU155 HALOBOX
	Use in dry rooms only!
	Follow special disposal instructions!
	Follow special assembly instructions!
IP00/66	IP protection level
	Mark of CE conformity
	Follow special disposal instructions!



### 2.4.2 Safety Notices

A safety notice is located on the top of the CU155 HALOBOX.

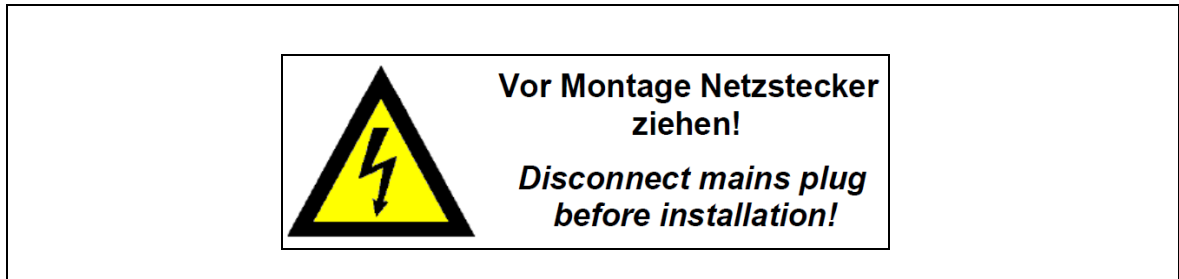
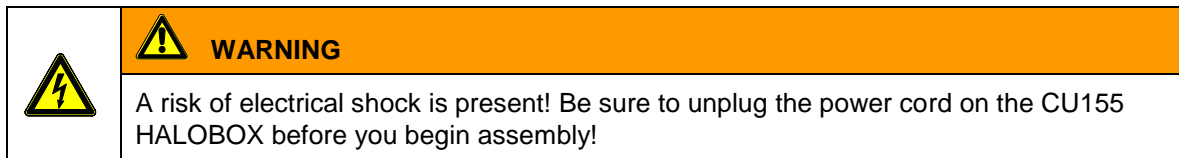

Figure 2 Safety notice on the CU155 HALOBOX



### 3. Description of component

The CU155 HALOBOX is a component for connecting a drive or drive control unit. It is also used for supplying power via an integrated transformer to one or two halogen lamps (which can be used for lighting under the bed).

A drive or drive control unit can be connected to the CU155 HALOBOX using the QUICKON® fast-connect system (included in delivery).

- ▶ Only DewertOkin drives and drive control units with protection level II can be connected to the CU155 HALOBOX. Two standard halogen lamps (12 V AC / max. 25 VA) can also be connected using DIN 41529 plugs.
- ▶ We reserve the right to make unannounced technical changes in the course of our continual product improvement process!

#### 3.1 Device components

The CU155 HALOBOX consists of housing with connections and a shield cover for protecting the sockets.

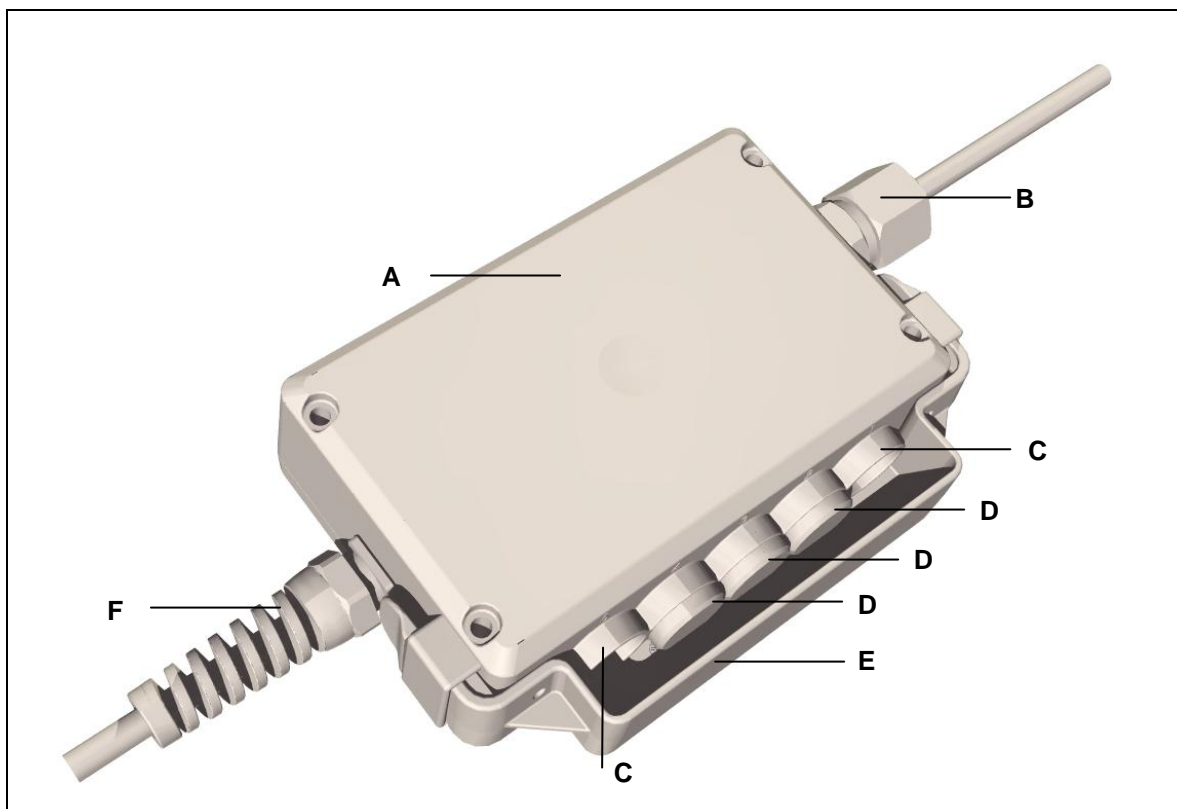

Figure 3 CU155 HALOBOX components

- |  |  |
|--|--|
| <b>A</b> CU155 HALOBOX                       | <b>B</b> Power supply for drive or drive control unit, with QUICKON® fast-connect system |
| <b>C</b> Two connection sockets for lamps    | <b>D</b> Three dummy plugs   |
| <b>E</b> Shield cover for protecting sockets | <b>F</b> Power supply for CU155 HALOBOX  |

The QUICKON® fast-connect system (included in the delivery) should be used to connect a drive to the CU155 HALOBOX (refer to Figure 11).

## 4. Technical Specifications

### 4.1 CU155 HALOBOX

Power supply / mains outlet	100 / 110 / 115 / 120 / 230 / 240 V AC 50-60 Hz
Output to fast-connect plug	100 / 110 / 115 / 120 / 230 / 240 V AC 0.63 A to 6 A (depending on transformer) / 50-60 Hz
Protection classification	II
Lamp connections	Two DIN 41529 loudspeaker plugs
Output to lamp connections	12V AC
Total output capacity	25 VA
Protection category	IP20 (optionally IP44 or IP66) Protection cat. IP44/66: Only valid when assembled with plugged-in power cord, drive cable ((QUICKON <sup>®</sup> ) and O-rings fitted to plugs.
Colours	Grey, black
Length x width x height	157 x 107 x 44 mm
Weight	Approx. 0.7 kg
<b>Ambient conditions for operation, storage and transport</b>	
Transport / storage temperature	From -20 °C to +50 °C From -4 °F to +122 °F
Operating temperature	From +10 °C to +40 °C From +50 °F to +104 °F
Relative humidity	From 30% to 75%
Air pressure	From 800 hPa to 1060 hPa
Altitude	< 2000 m

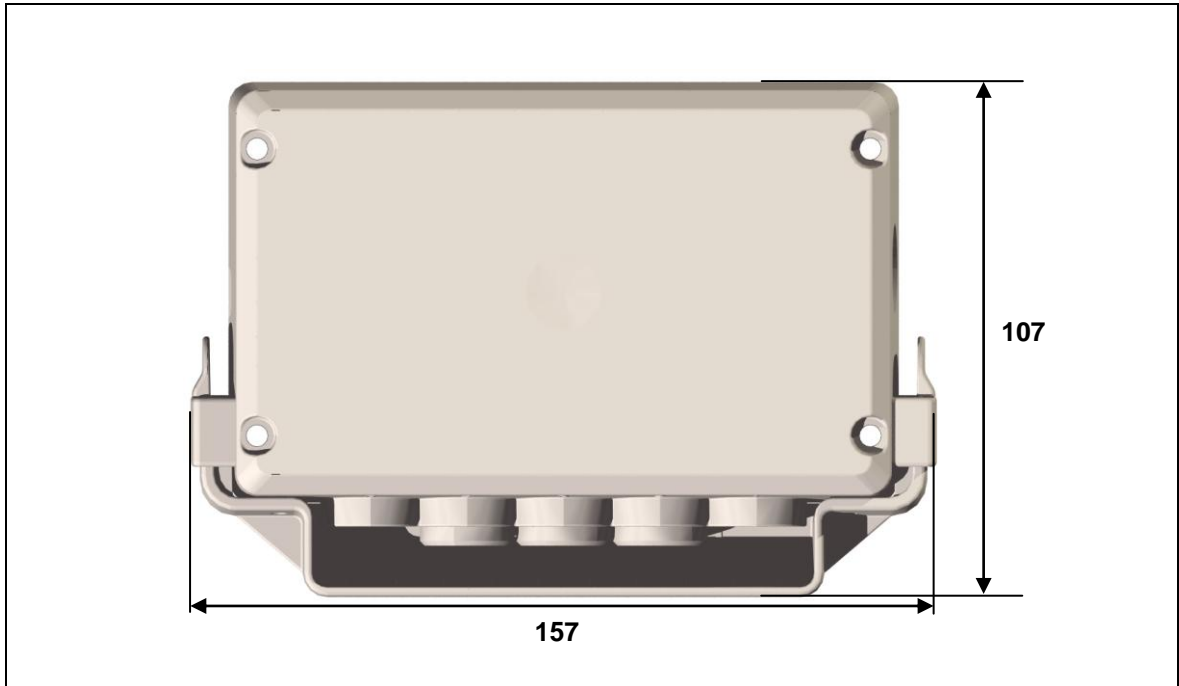

Figure 4 Dimensions of the CU155 HALOBOX (in mm), viewed from above

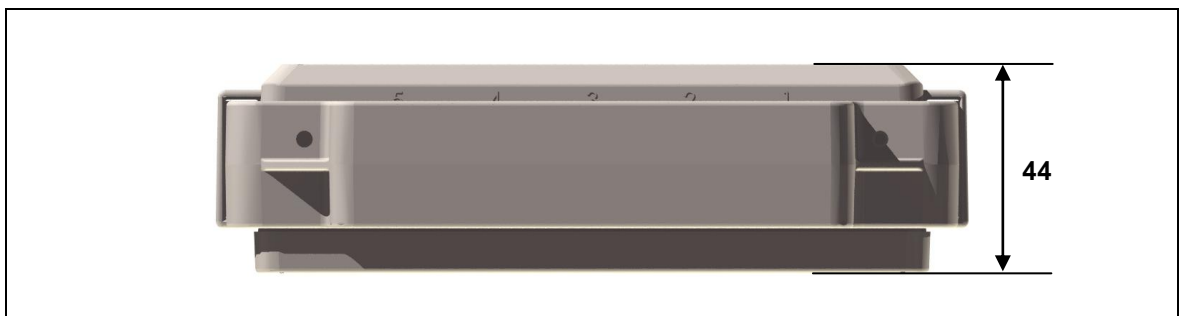

Figure 5 Dimensions of the CU155 HALOBOX (in mm), side view

## 4.2 QUICKON<sup>®</sup> fast-connect plug

Rated voltage	250 V AC (III/3)
Rated current at max. 40 °C	17.5 A
Protection classification	IP65 / IP67
Operating temperature	-25°C to +100°C
Threaded connection to housing	PG 11
Torque for coupling nut	2.5 Nm
Torque for the contact carrier and the locknut	3.75 Nm
Cross-section of wire cores	0.75 to 1.5 mm <sup>2</sup>
Core diameter including insulation	≤ 3 mm
Smallest allowed wire core diameter	0.2 mm
Insulation stripping length	15 mm
Diameter of the wire's outer cladding	4 to 7.5 mm

## 5. Installation

### 5.1 Safety notices to observe during installation

Basic safety rules must be followed in order to ensure that the end product can be continually operated in a safe manner. These rules must be observed while using the end product and while installing the CU155 HALOBOX.

#### 5.1.1 Ensuring operational reliability during installation

The safety and reliability of the end product containing DewertOkin components can be ensured by using the proper construction methods described below.

	<b>NOTICE</b>
	Do not remove the three dummy plugs from the three unused sockets on the CU155 HALOBOX.

#### Surge voltages

The CU155 HALOBOX transformer is protected from surges by a safety fuse. Both lamp sockets are also equipped with a self-resetting fuse for surge voltages.

#### Overheating

A thermal fuse will shut off the CU155 HALOBOX if the temperature exceeds 130° C.

#### Mechanical construction

A shield covering the sockets protects the lamp connections from mechanical damage and accidental unplugging.

### 5.2 Installation procedure

Before installing the CU155 HALOBOX, make sure that you are observing all of the safety notices found in the "Safety notices to observe during installation" section.

### 5.2.1 Installation and dismantling for the CU155 HALOBOX

	<b>CAUTION</b>
The mains power plug should be unplugged during the installation.	

There are four mounting holes in the CU155 HALOBOX which can be used to attach it to the end product with the appropriate screws (for example, M4 x 50 screws). The CU155 HALOBOX should be mounted so that it lies flat against its supporting material. In the end product, no mechanical forces (such as torsion) should be put on the CU155 HALOBOX or enclosure. Such forces could lead to damage (such as cracks) in the housing.

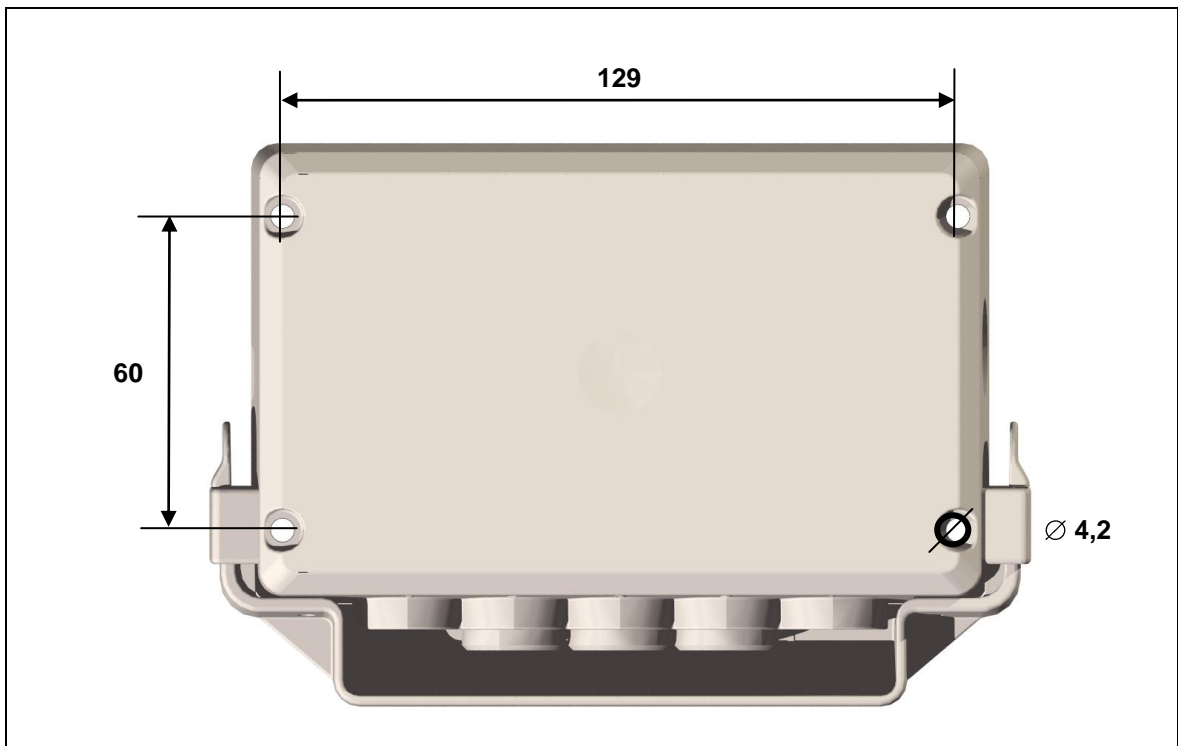

Figure 6 CU155 HALOBOX mounting holes (dimensions in mm)

### 5.2.2 Mounting the shield cover over the sockets

The shield cover is attached to the CU155 HALOBOX by snapping it into the guide slots. It can also be attached more securely to the CU155 HALOBOX using suitable screws ((ST 2.9 x 6.5; ISO 7049).

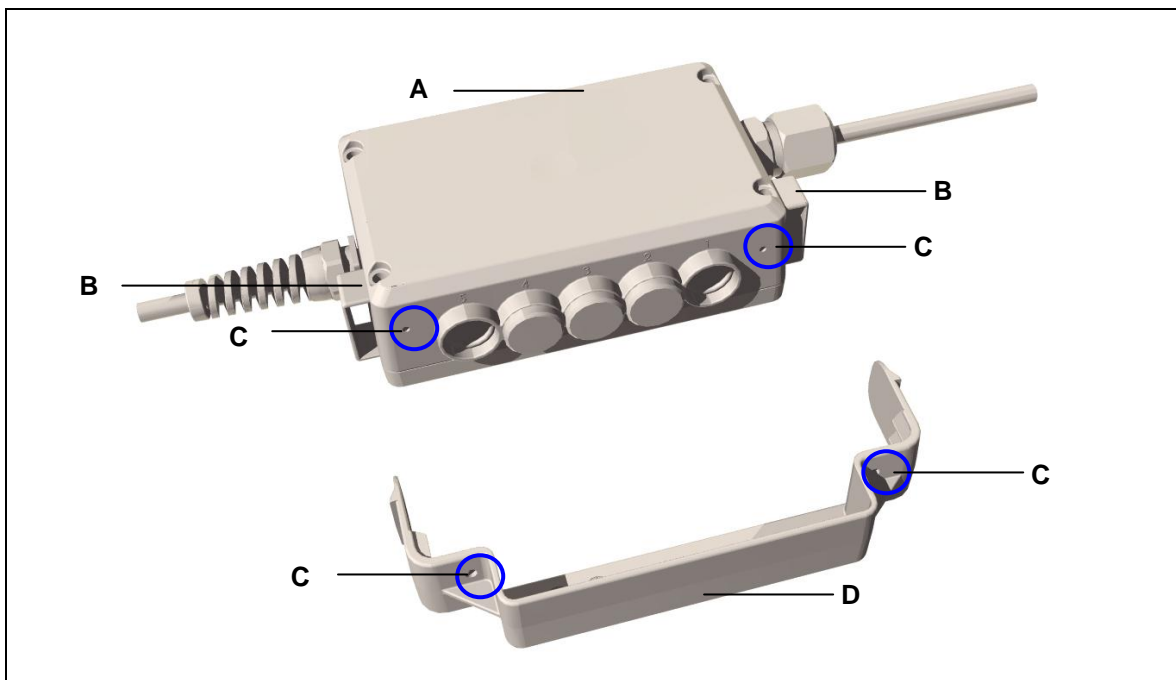

Figure 7 Shield cover for the CU155 HALOBOX

**A** CU155 HALOBOX

**B** Guide slots

**C** Holes for screws

**D** Shield cover for protecting sockets

### 5.2.3 Connecting the halogen lamps

- 1 If necessary, unscrew both screws on the shield cover.
- 2 Pull out the shield over from the guide slots.
- 3 Connect the lamp to one of the available lamp sockets.





#### NOTICE

Only use DIN 41429 angle plugs with rubber seals to connect the lamps.

- 4 The shield cover is attached to the CU155 HALOBOX by snapping it into the guide slots.
- 5 If necessary, screw both screws for the shield cover back into the CU155 HALOBOX.



**5.2.4 Electrical connection**

	 <b>CAUTION</b>
Electrical components should be connected or disconnected only when the mains power cord is unplugged.	

**Routing electrical cables**

When routing the cables, be sure that:

- the cables cannot get jammed,
- no mechanical load (such as pulling, pushing or bending) will be put on the cables, and
- the cables cannot be damaged in any way.

Fasten all cables (especially the connecting cables) to the end product using sufficient strain relief and kink prevention methods. Be sure that the design of the end product prevents the connecting cables from coming into contact with the floor during transport.

**5.2.5 Mounting the CU155 HALOBOX and the drive/drive control unit**



	 <b>CAUTION</b>
You should only connect and disconnect the cables when they are completely disconnected from any live current!	



Figure 8 Drive / drive control unit

**A** Power cord on the drive or drive control unit    **B** Drive / drive control unit

- 1 Sever the power plug from the drive or drive control unit. Then cut the power cable to the desired length.

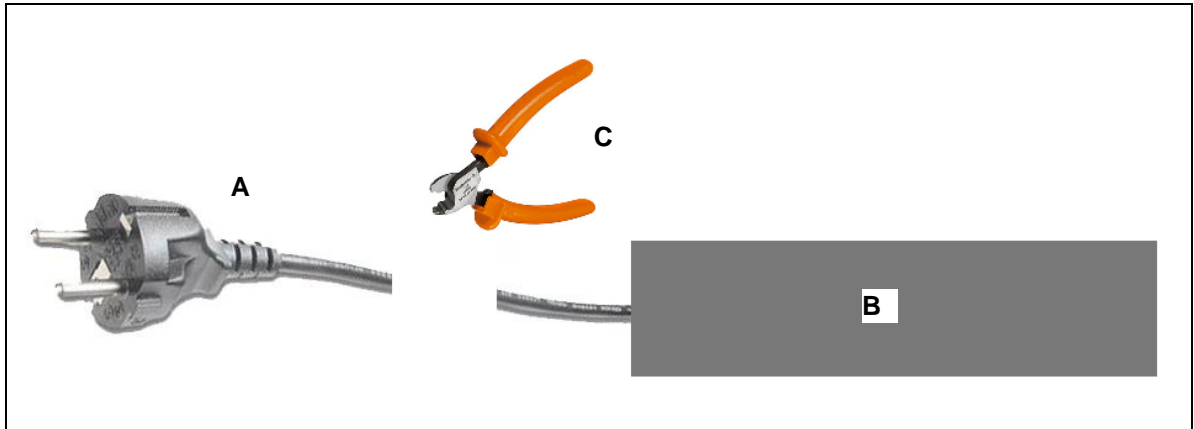

Figure 9 Cut off the power cord and trim the cable

- A** Power cord on the drive or drive control unit
- B** Drive / drive control unit
- C** Cut off the cable

2 Connect the cable from the drive or drive control unit to the CU155 HALOBOX, as described in section "Assembling the QUICKON® fast-connect plug".

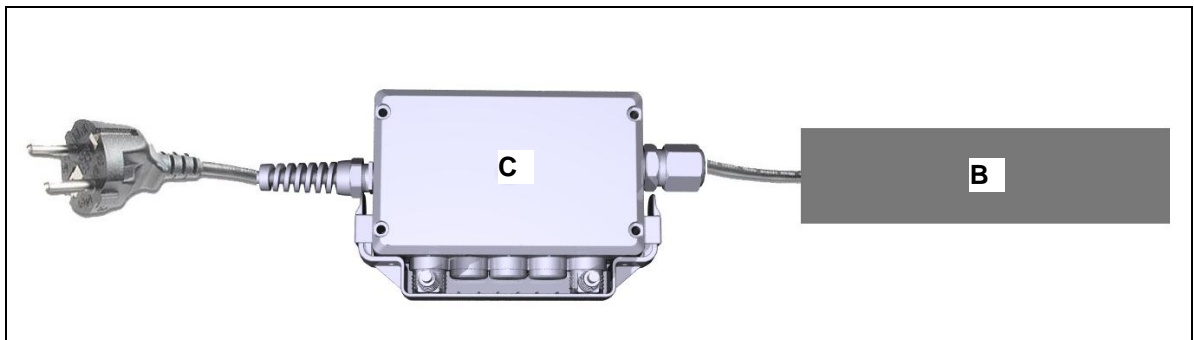



Figure 10 Connecting the CU155 HALOBOX and the drive/drive control unit

- A** Power cord for the CU155 HALOBOX
- B** Drive / drive control unit
- C** CU155 HALOBOX

### 5.2.6 Assembling the QUICKON<sup>®</sup> fast-connect plug

	<b>CAUTION</b>
	<p>When the QUICKON<sup>®</sup> fast-connect plug is delivered, the coupling nut cannot be manually loosened. An appropriate tool must be used to loosen the nut.</p> <p>You should only connect and disconnect the cables when they are completely disconnected from any live current!</p>

	<b>NOTICE</b>
	<p>A single contact unit can be disconnected and reconnected no more than ten times. When reconnecting the cable, be sure to first cut off the ends of the wire which were previously connected.</p> <p>You should have the same wire core diameter if you are using a new cable. A gas-tight contact connection will be guaranteed if you follow this procedure.</p> <p>The sealing and cap should be replaced if necessary after repeated cable connections.</p>

- ▶ Currently only two-wire power cables can be used to connect with the QUICKON<sup>®</sup> fast-connect plugs.

- 1 Cut the connecting cable to your required length.

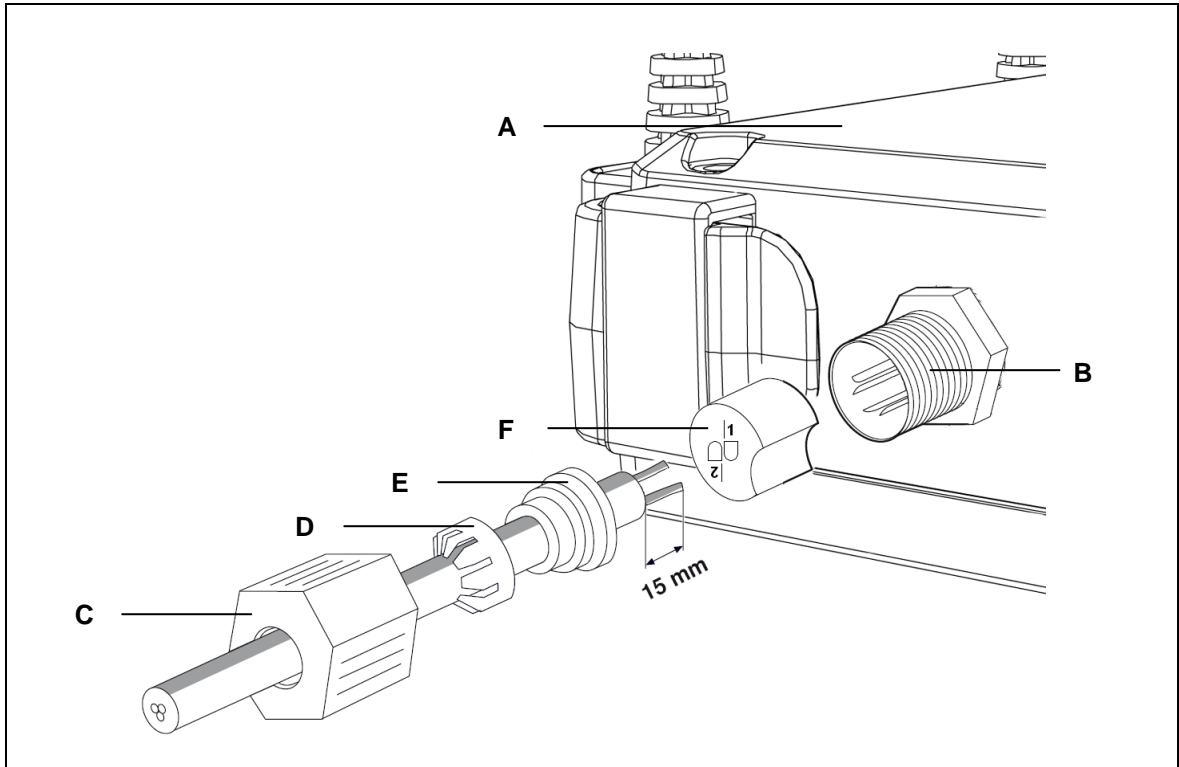

Figure 11 Assembling the QUICKON® fast-connect plug (1)

- |                        |                          |
|------------------------|--------------------------|
| <b>A</b> CU155 HALOBOX | <b>B</b> Contact carrier |
| <b>C</b> Coupling nut  | <b>D</b> Cap             |
| <b>E</b> Rubber seal   | <b>F</b> Splice ring     |

- 2 Strip about 15 mm of the insulation off the cable (refer to Figure 11). Then insert the coupling nut, the cap and the rubber seal on the cable. Be sure not to strip the wires within the cable!
- 3 Push the seal in until it is positioned at the edge of the insulation. Then put the cap on the seal. This creates a strain relief mechanism for the cable (refer to Figure 12).

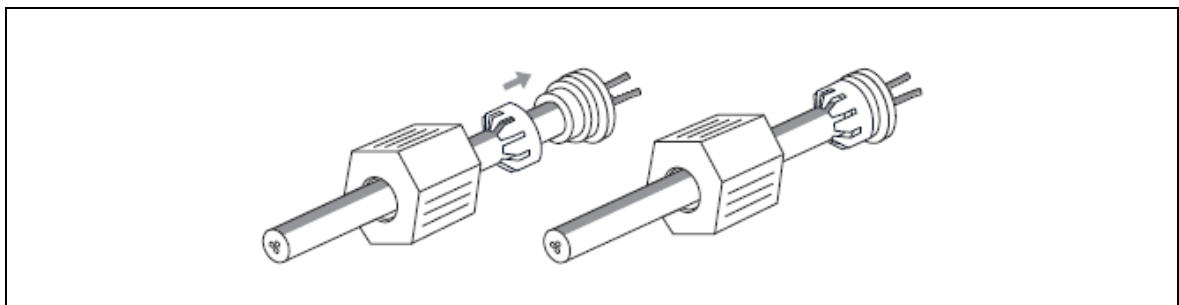

Figure 12 Assembling the QUICKON® fast-connect plug (2)

- 4 Insert the wire core ends into the openings in the splice ring (refer to Figure 13). The individual wire holes in the splice ring are numbered (1 and 2) so that wire ends can be clearly assigned.

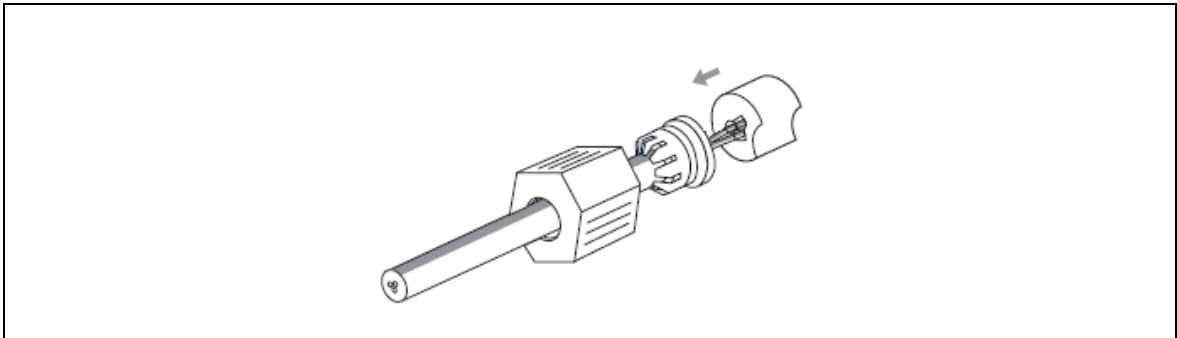

Figure 13 Assembling the QUICKON® fast-connect plug (3)

- 5 Cut off any remaining wire end. The wire ends should be positioned so that they are flush with the splice ring. A slight overlap (up to 3 mm) is permissible. Be sure, however, that they are not too short!
- 6 Insert the prepared cable into the contact carrier on the CU155 HALOBOX.
- 7 Turn the cable with the splice ring until the coding notch fits exactly into the corresponding guide positions (refer to Figure 14).

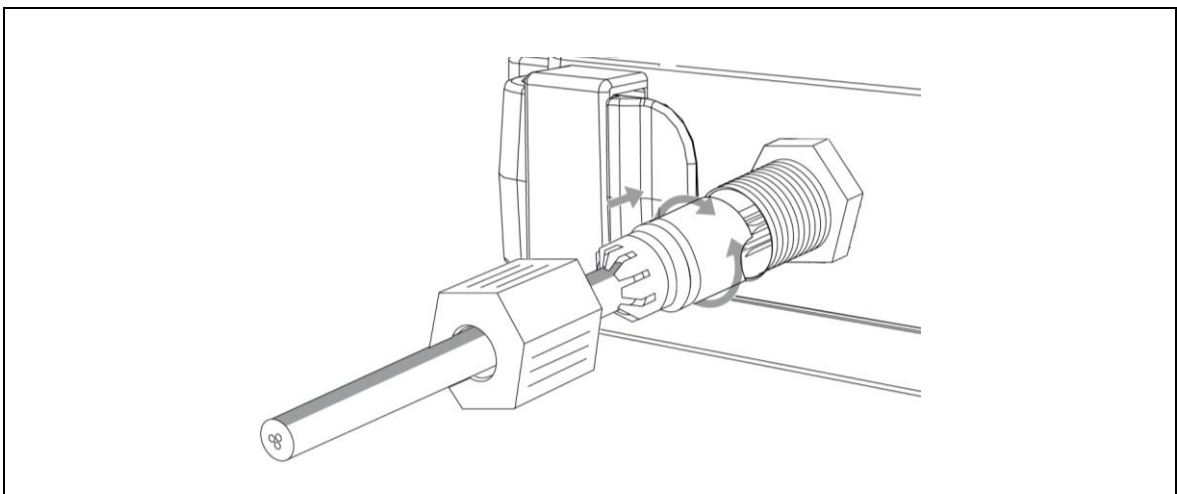

Figure 14 Assembling the QUICKON® fast-connect plug (4)



- 8 Apply 2.5 Nm torque to tighten the coupling nut and thus close the screw connection. This will press the wire ends into the insulation displacement terminals, which cut through the insulation and establish the electrical contact.

#### Disconnecting the QUICKON® fast-connect plug

- 1 Turn the coupling nut until it is unscrewed from the contact carrier.
- 2 Pull on the cable in order to separate the wires from the terminal points in the contact carrier.
- 3 Remove any insulation and cable sheathing remains that are in the terminal points in the contact carrier.
- 4 Cut off about 20 mm from the end of the cable before you reconnect it.

## 6. Notices for operation



The factual information contained within may be used when you are creating the end-product manual. The installation instructions do not contain all information required for the safe operation of the end product. They only describe the assembly and operation of the CU155 HALOBOX as a partially assembled piece of machinery.

	 <b>CAUTION</b>
	<p>When creating the operating instructions, remember that the installation instructions are intended for qualified specialists and are not for typical users of the end product.</p>

### 6.1 General notice



- ▶ Only drive and drive control units from DewertOkin should be connected to the CU155 HALOBOX since they have already been verified to work together.
- ▶ Only those lamps which comply with the technical specifications provided here should be connected to the CU155 HALOBOX.

#### Emergency shutoff of a connected drive or drive control unit

	 <b>CAUTION</b>
	<p>In an emergency, disconnect the CU155 HALOBOX power plug in order to shutoff the connected drive or drive control unit. The power plug must always be accessible during operations so that it is possible to shut down the drive or drive control unit at any time.</p>



#### Avoiding cable damage

Be sure that your operating instructions inform the user about the possible cable risks.

	 <b>CAUTION</b>
	<p>The cables (particularly the connecting cable) should not be run over. In order to prevent injuries or damage to the CU155 HALOBOX, no mechanical strain should be placed on the cables.</p>



## 7. Troubleshooting

This chapter describes troubleshooting methods for fixing problems. If you experience an error that is not listed in this table, please contact your supplier.

	 <b>CAUTION</b>
	<p>Only qualified specialists who have received electrician training should carry out troubleshooting and repairs.</p>

Problem	Possible cause	Remedy
The drive or drive control unit is not functioning	There is no mains supply voltage.	Connect the mains power.
	The drive or drive control unit is defective.	Please contact your supplier or sales agent.
The drive is suddenly no longer capable of movement.	The thermal fuse on the transformer may have been triggered.	Please contact your supplier or sales agent.
	The device fuse may have been triggered.	Please contact your supplier or sales agent.
	There is no mains supply voltage.	Connect the mains power.
	The power feed (from the mains) has been interrupted.	Check the lead-in connections and re-seat the contacts if required.
The lamps are not functioning.	There is no mains supply voltage.	Connect the mains power.
	The power feed (from the mains) has been interrupted.	Check the lead-in connections and re-seat the contacts if required.
	The fuse for the lamp connections may have been triggered.	Wait five minutes until the fuse automatically resets itself.

## 8. Maintenance

	 <b>CAUTION</b>
	<p>You should only use spare parts which have been manufactured or approved by DewertOkin. Only these parts will guarantee a sufficient level of safety.</p>

### 8.1 Maintenance

Type of check	Explanation	Time interval
Check the function and safety of the electrical system	A qualified electrician should carry out this inspection. (Refer to the "Electrical connection" section in the "Installation" chapter.)	Periodic inspections can be carried out at intervals based on the risk assessment which you conduct for your end product.
Periodic visual inspection for housing damage	Check the housing for breaks or cracks.	At least every six months
Periodic visual inspection of the plug-in connections and electrical access points for damage	Check that all electrical cables and connections are firmly seated and correctly positioned.	At least every six months
Periodic visual inspection for cable damage	Check the connecting cables for pinching or shearing. Also check the strain relief and kink protections mechanisms, in particular after any mechanical load.	At least every six months

### 8.2 Cleaning and care

The CU155 HALOBOX was designed so that it would be easy to clean. Its smooth surfaces can be conveniently cleaned.

	<b>NOTICE</b>
	<p>Never clean the CU155 HALOBOX in an automated washing system or with a high-pressure cleaner. Do not allow fluids to penetrate the drive. Damage to the drive could result.</p> <p>Do not use a cleanser that contains benzene, alcohol or similar solvents.</p>

- 1 Always disconnect the mains power plug before you start to clean the drive!
- 2 Clean the CU155 HALOBOX using a moist cloth.
- 3 Be sure that you do not damage the connecting cables during the cleaning.



## 9. Disposal

The CU155 HALOBOX consists of electronic components, cables and metal and plastic parts. You should observe all corresponding national and regional environmental regulations when disposing of the CU155 HALOBOX.

The disposal of the end product is regulated in Germany by Elektro-G, internationally by the EU Directive 2002/95/EC (RoHS, from 1 Jul. 2006) and Directive 2011/65/EU (RoHS, from 3 Jan. 2013), or by any applicable national laws and regulations. (The end product is not regulated by the EU Directive 2002/96/EC (WEEE) and its amendment EU Directive 2003/108/EC.)



The CU155 HALOBOX should not be disposed of with normal household waste!

## EU Declaration of conformity

In compliance with Appendix IV of the EU EMC Directive 2004/108/EG

In compliance with Appendix III of the EU Low Voltage Directive 2006/95/EG

In compliance with Appendix VI of the EU RoHS Directive 2011/65/EU

The manufacturer:

DewertOkin GmbH

Weststraße 1

32278 Kirchlengern, Germany

declares that the following product

### **CU155 HALOBOX with DewertOkin control unit**

meets the requirements of the following EU directives:

**Electromagnetic Compatibility Directive 2004/108/EG**

**Low Voltage Directive 2006/95/EG**

**RoHS Directive 2011/65/EU of the European Parliament and of the Council of 8 June 2011 on the restriction of the use of certain hazardous substances in electrical and electronic equipment**

Applied standards:

- EN 60335-1:2012
- EN 55014-1/A1:2009
- EN 55014-2/A2:2008
- EN 61000-3-2/A2:2009
- EN 61000-3-3:2008
- EN 62233:2008

This declaration of conformity is no longer valid if constructional changes are made which significantly change the control unit (i.e., which influence the technical specifications found in the instructions or the intended use)!

Kirchlengern, Germany on 15 December, 2012



Sascha Koltzenburg

Head of R & D



DewertOkin GmbH  
Weststraße 1  
32278 Kirchlengern, Germany  
Tel: +49 (0)5223/979-0  
Fax: +49 (0)5223/75182  
<http://www.dewertokin.de>  
[Info@dewertokin.de](mailto:Info@dewertokin.de)

ID No.: 64413