



HE-300 SMPS POWER SUPPLY

Installation Instructions

(Translation of the original installation instructions)

Foreword

Disclaimer and exclusion of liability

DewertOkin is not responsible for damage resulting from:

- failure to observe these instructions,
- changes made to this product which have not been approved by DewertOkin, or
- the use of replacement parts which have not been approved or manufactured by DewertOkin.

- ▶ We reserve the right to make unannounced technical changes in the course of our continual product improvement process!

Creation of a complete operating instruction manual for the entire end product

These instructions are only intended to be used by the end-product manufacturer. They should not be given to the operator of the end product. The factual information contained within may be used as a basis when creating the end-product manual.

The warning and danger notices are best suited for use in the end product's manual. However it is not sufficient to simply follow these notices. You should also carry out an internal risk assessment for your end product. This can then be used as the basis for the safety notices in your manual.

These installation instructions do not contain all information required to safely operate the end product. They only describe the installation and operation of the product as partially completed machinery.

The instructions are intended for the technicians responsible for manufacturing an end product and not for the operators of the end product.

Table of contents

Foreword	3
Disclaimer and exclusion of liability	3
Creation of a complete operating instruction manual for the entire end product	3
Table of contents	4
1. General Information	5
1.1 Conventions used	5
2. Safety notices	6
2.1 Proper and intended usage	6
2.2 Selection and qualification of personnel	7
2.3 Ratings plate	8
3. Description	9
3.1 Components	9
4. Technical specifications	12
4.1 POWER SUPPLY	12
5. Installation	14
5.1 Safety notices to observe during installation	14
5.2 Installation procedure	15
6. Information about creating your Operating Manual	22
6.1 General information	22
6.2 battery-operated reset function	24
7. Troubleshooting	25
8. Maintenance and cleaning	26
8.1 Maintenance	26
8.2 Cleaning and care	26
9. Disposal	27
9.1 Packaging material	27
9.2 Components of the external power supply unit	27
EU Declaration of Conformity	28
Additional information	29

1. General Information

These installation instructions must be followed closely in order to install the HE-300 SMPS POWER SUPPLY successfully and safely in the end product. These instructions are not an operating manual for the end product.

These instructions will help you to minimize danger. They will also help you to maximize the reliability and lifespan of the end product.



CAUTION

The notices in these instructions must be followed! Follow the guidelines during installation and connection procedures to minimize:

- the risk of accident and injury, and
- damage to the HE-300 SMPS POWER SUPPLY or to the end product.

These installation instructions have been written with due care and attention. However, we cannot guarantee that the data, images and drawings are complete and correct nor do we accept any liability for the information contained therein, unless required by law.

1.1 Conventions used

Notices which do not relate to safety are indicated in these instructions with a symbol:

- ▶ Triangular notice symbol

Safety notice explanations



CAUTION

CAUTION indicates a hazardous situation which, if not avoided, could result in minor or moderate injury.

NOTICE

NOTICE is used to address practices which are not related to personal injury but may result in damage to the product or surroundings.

2. Safety notices

2.1 Proper and intended usage

The HE-300 SMPS POWER SUPPLY is intended for use:

- as a power supply unit for suitable DewertOkin drive systems,



CAUTION

Risk of accident

This HE-300 SMPS POWER SUPPLY should only be used for the applications described above. Any other use is forbidden. Improper usage can lead to accidents or destruction of the unit. Such non-approved applications will lead immediately to the expiration of all guarantee and warranty claims on the part of the end-product manufacturer against the manufacturer.

2.1.1 Improper usage

Be sure to follow the notices below concerning improper usage. You should include them in your product manual in order to inform the users of your end product.

The HE-300 SMPS POWER SUPPLY may not be used:

- in any environment where combustible or explosive gases or vapours (e.g., anaesthesiology) may be present,
- in the proximity of open fires or other heat sources (such as furnaces, ovens or direct sunlight),
- as a power source for toys or games,
- in any application that will be cleaned with an automated washing system,
- in a moist environment, or
- outdoors.

The HE-300 SMPS POWER SUPPLY can be used by children of 8 years and older, persons with reduced physical, sensory or mental capabilities, or persons with lack of experience or knowledge when they are supervised or instructed concerning the safe use of the device and when they understand the resulting risks. Do not allow children to play with this device. The cleaning and user maintenance must not be carried out by children without supervision.

- ▶ You should only use spare parts which have been manufactured or approved by DewertOkin. Only these parts will guarantee a sufficient level of safety.

Optional: battery-operated reset function**NOTICE**

The battery-operated reset function is not a safety system and does not avert danger.

DewertOkin does not guarantee that the drive will function in the event of a power outage.

If the end-product manufacturer chooses to guarantee the functionality of the end product during a power outage, then the end-product manufacturer is responsible for arranging a mechanism to ensure this functionality.

2.2 Selection and qualification of personnel

This HE-300 SMPS POWER SUPPLY should only be installed into the end product by someone who has completed training in electronic motor assembly or has equivalent qualifications.

You should only install the HE-300 SMPS POWER SUPPLY when you are qualified to do so. Otherwise, a properly qualified person should be found for this task.

2.3 Ratings plate

- ▶ The ratings plate shown is an example; the specifications for your HE-300 SMPS POWER SUPPLY may differ from this illustration.

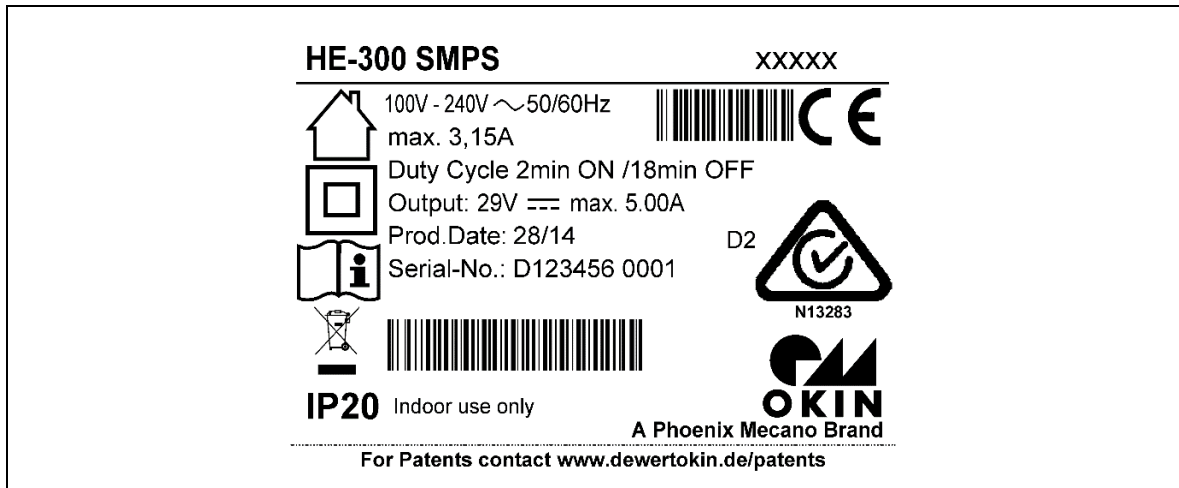





Figure 1 Ratings plate for the HE-300 SMPS POWER SUPPLY (example)

HE-300 SMPS	Model name
xxxxx	Model ID number
100V - 240V ~	Input voltage AC
50/60Hz	Frequency
max. 3,15A	Current consumption
Duty Cycle 2min ON /18min OFF	Intermittent operations: 2 minutes on / 18 minutes OFF
Output: 29V ---	Output voltage DC
max. 5.00A	Amperage
Prod.Date	Calendar week / year
Serial-No.	Serial number of the HE-300 SMPS POWER SUPPLY
IP20	Protection degree
CE	Compliance
	Use in dry rooms only!
	Protection class II
	Always follow the instructions in the manual!
	Follow all special disposal instructions!

3. Description

The HE-300 SMPS POWER SUPPLY is an external power supply unit intended to supply power to drives and controllers from DewertOkin. The HE-300 SMPS POWER SUPPLY is connected to the mains power by using a mains power cord. The HE-300 SMPS POWER SUPPLY has a non-referenced (unearthed) circuit which is separated from the supply voltage by means of doubled reinforced insulation.

A pluggable cable is used for connecting a double drive or drive control unit to the HE-300 SMPS POWER SUPPLY.

The function key is used for:

- operating the electrical reset function,
- optionally, programming the hand-held remote control.

There are two mounting plates included in the delivery; these can be used when bolting the HE-300 SMPS POWER SUPPLY onto the end product.

3.1 Components

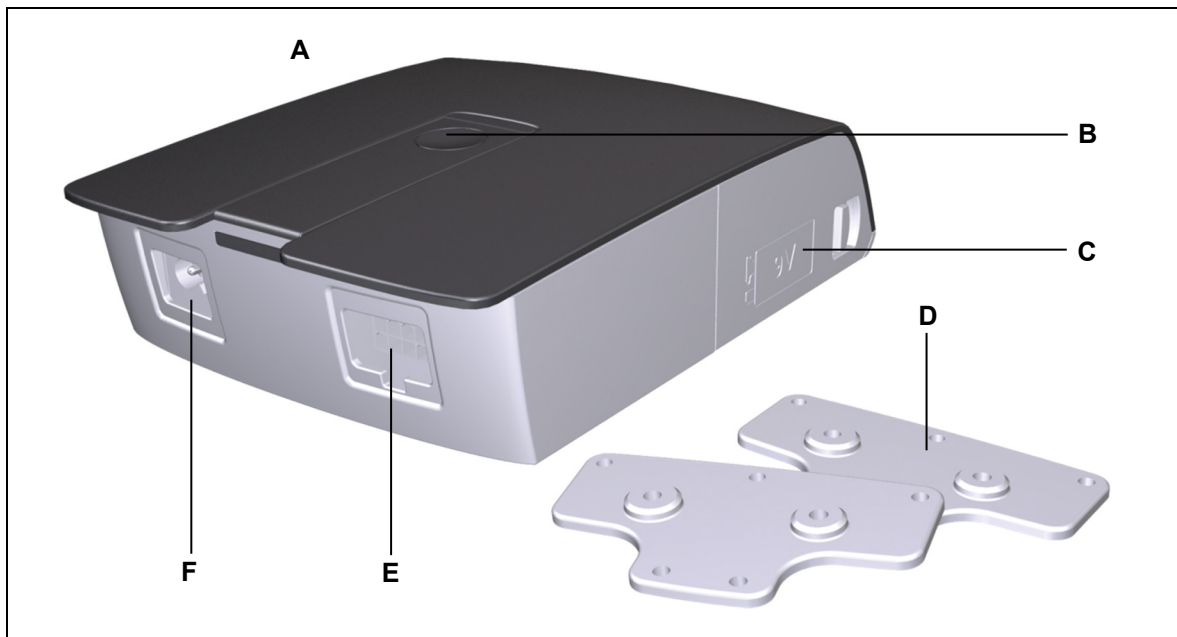

Figure 2 Components of the HE-300 SMPS POWER SUPPLY

- | | |
|--|--------------------------|
| A HE-300 SMPS POWER SUPPLY | B Button |
| C Battery compartment | D Mounting plates |
| E Socket for the connecting cable
(e.g., to the HE-300 CONTROL UNIT) | F Power socket |

3.1.1 Mains power supply connection

**CAUTION****Electric shock**

Please follow these operating instructions carefully. You could be injured by fire or electrical shock if you do not follow these assembly instructions.

Optional: Power cord

The optional power cord is included for your region (either EURO continental Europe, the UK or Australia).

**CAUTION**

Only use the proper power cord that is permitted in your country. Be sure to use the correct plug adapter, as described in Figure 3.

- ▶ More information about the intended power supply cord can be found in the "Additional Information" section.

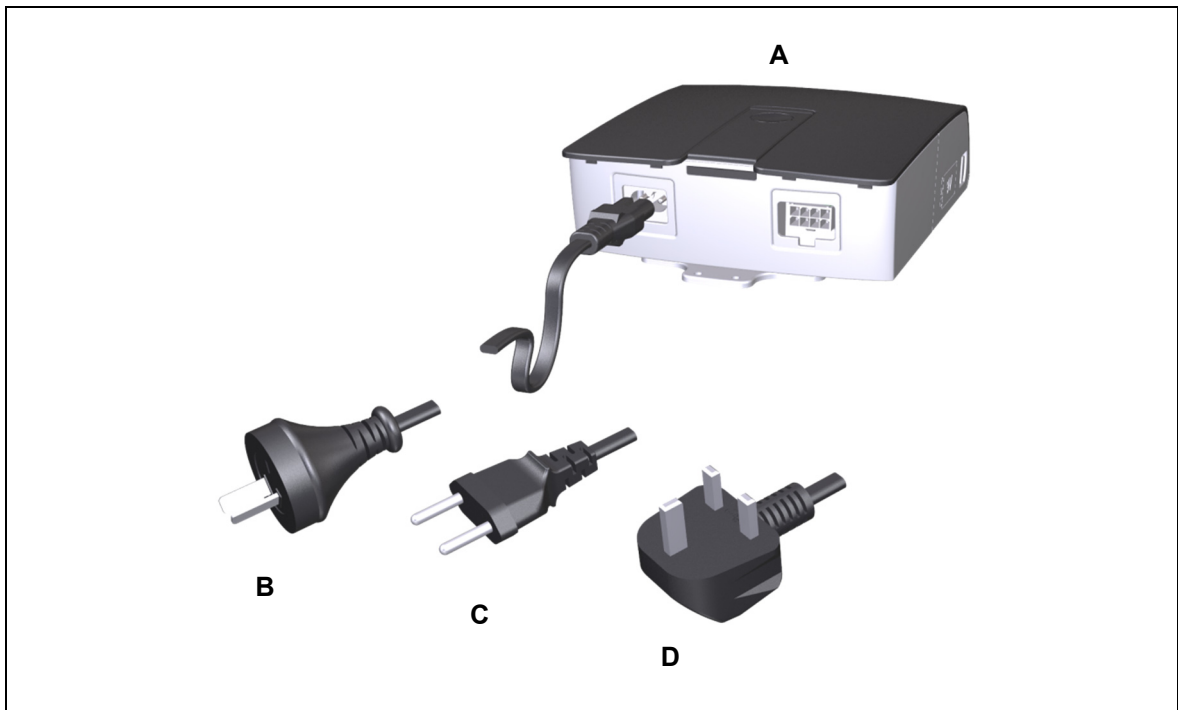

Figure 3 Power cord, regional variants

A HE-300 SMPS POWER SUPPLY

B Power plug (Australia)

C Power plug (EURO)

D Power plug (UK)

3.1.2 Nine-volt batteries for reset function independent of mains power supply

The battery compartment in the HE-300 SMPS POWER SUPPLY holds two nine-volt batteries. The batteries are required if you need to use the battery-operated drive reset function (not dependent on the mains).

**CAUTION**

The battery-operated reset function is not a safety system and does not avert danger.

DewertOkin does not guarantee that the drive will function in the event of a power outage.

If the end-product manufacturer chooses to guarantee the functionality of the end product during a power outage, then the end-product manufacturer is responsible for arranging a mechanism to ensure this functionality.

4. Technical specifications

4.1 POWER SUPPLY

Mains power supply connection	100 – 240 V AC 50/60 Hz
Output voltage	Max. 29 V DC
Output current	Max. 5.00 A for intermittent duty of 2 min / 18 min
Primary fuse	4 A
Standby (no load)	≤ 0.5 W
Mode of operations ¹	Intermittent duty 2 min./18 min. Continuous operations
Protection class	II
Protection degree	IP20
Colours	Black
Length of power cord ²	approx. 1200 mm
battery-operated reset function	
Voltage	Two nine-volt batteries (6LR61)
Dimensions and weight	
Length x width x height	Approx. 193 mm x 140 mm x 53 mm
Weight	Approx. 660 g
Ambient conditions for operation, storage and transport	
Transport / storage temperature	From -20 °C to +50 °C From -4 °F to +122 °F
Operating temperature	From +10 °C to +40 °C From +50 °F to +104 °F
Relative humidity	From 30% to 75%
Air pressure	From 800 hPa to 1060 hPa
Height	< 2000 m

¹ Mode of operation: intermittent duty 2 min./18 min. This means that after the unit is operated with its rated load for up to two minutes it must then be paused for 18 minutes. The system can malfunction if this pause is not observed!

² Versions with a power cord shorter than 2 meters are only suitable for outlets near the floor.

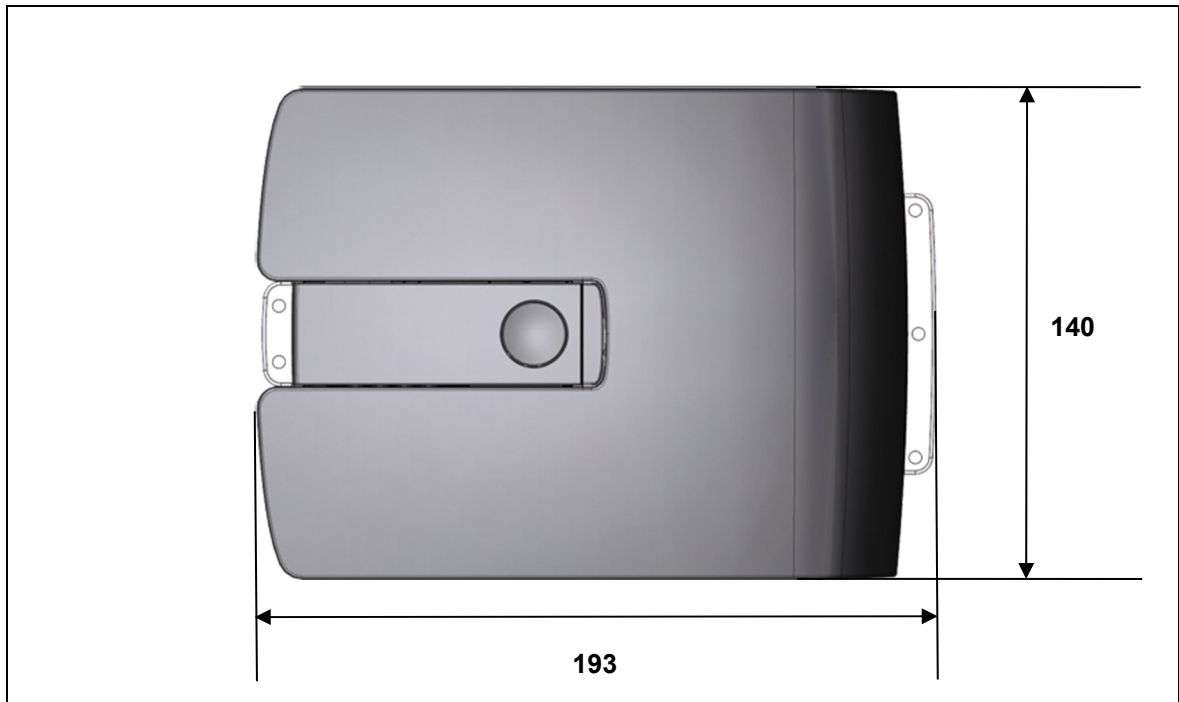

Figure 4 Dimensions of the HE-300 SMPS POWER SUPPLY, in mm, top view

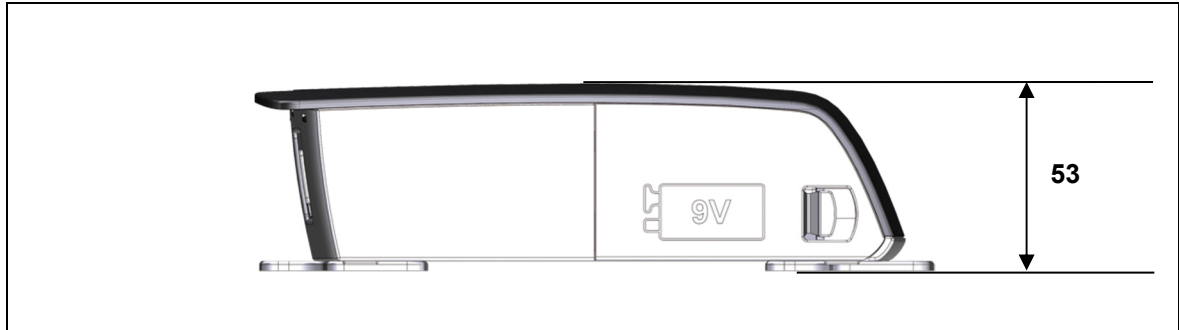

Figure 5 Dimensions of the HE-300 SMPS POWER SUPPLY, in mm, side view

5. Installation

5.1 Safety notices to observe during installation

Basic safety rules must be followed in order to ensure that the end product can be continually operated in a safe manner. These rules must be observed while using the end product and while installing the HE-300 SMPS POWER SUPPLY in the end product.

Avoiding electrical faults

Be sure to consider the length of the power cord when designing the dimensions for your end product in order to minimize the associated risks.

Overheating

A thermal circuit breaker in the HE-300 SMPS POWER SUPPLY switches the unit off when it overheats.



CAUTION

Risk of accident

The HE-300 SMPS POWER SUPPLY is equipped with a thermal fuse that triggers when the unit overheats. If the temperature control has triggered, remove the HE-300 SMPS POWER SUPPLY from the power supply, allow it to rest for 20 to 30 minutes and try again. If the unit still does not function, please contact your supplier or dealer.

5.2 Installation procedure

Before installing and connecting the HE-300 SMPS POWER SUPPLY, make sure that you are observing all of the safety notices found in the "Safety notices to observe during installation" section.

5.2.1 Attaching the mounting plates

Screws should be screwed into the five mounting points on the two mounting plates for attaching the HE-300 SMPS POWER SUPPLY to the end product. Two screws are used for each of the two delivered mounting plates to attach them to the HE-300 POWER SUPPLY.

- ▶ The drilling dimensions shown in Figure 6 only illustrate an example and are not necessarily authoritative for all applications.

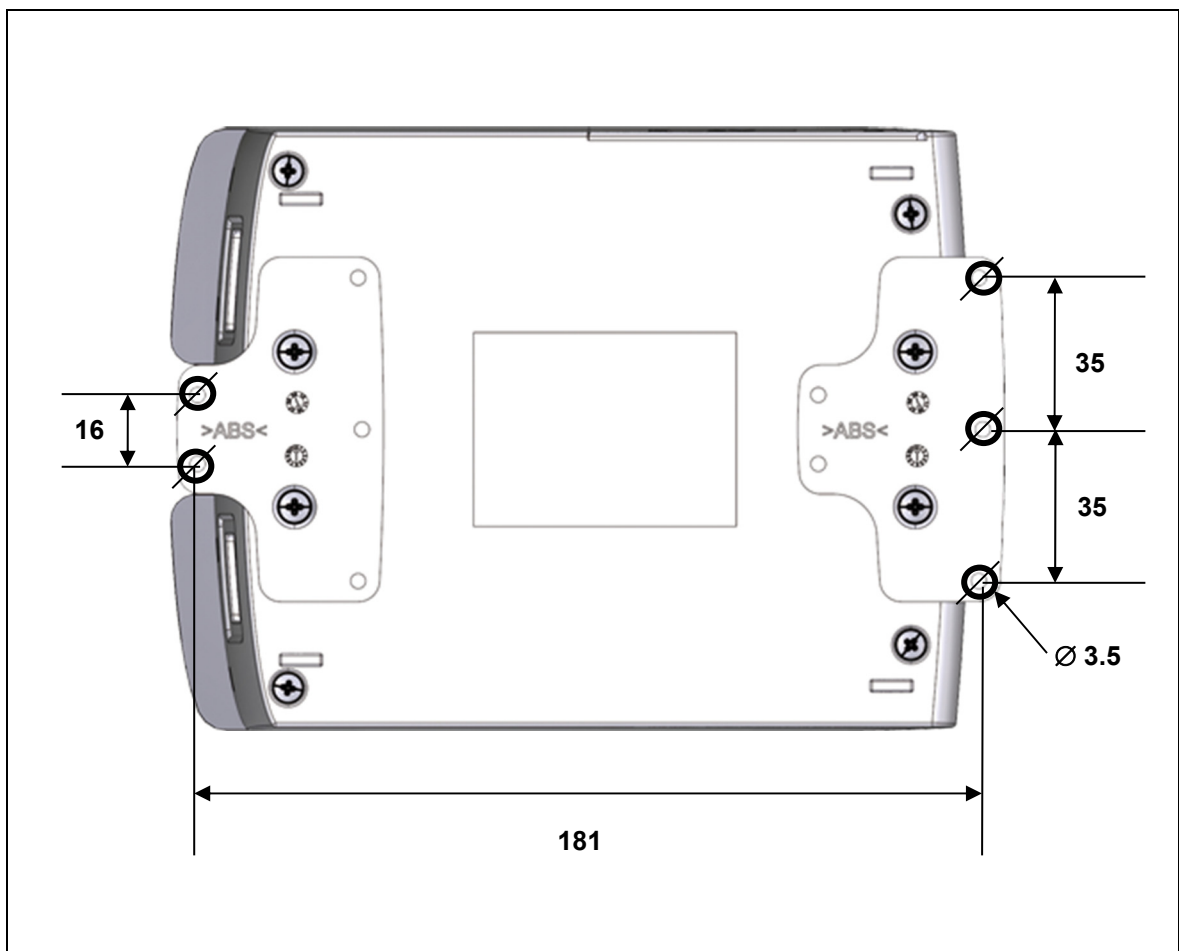

Figure 6 Example: Mounting points on the HE-300 SMPS power supply (in mm)

- 1 Screw the mounting plates firmly onto the HE-300 SMPS POWER SUPPLY SMPS (as shown in Figure 7). Use at least two screws for each of the two mounting plates.

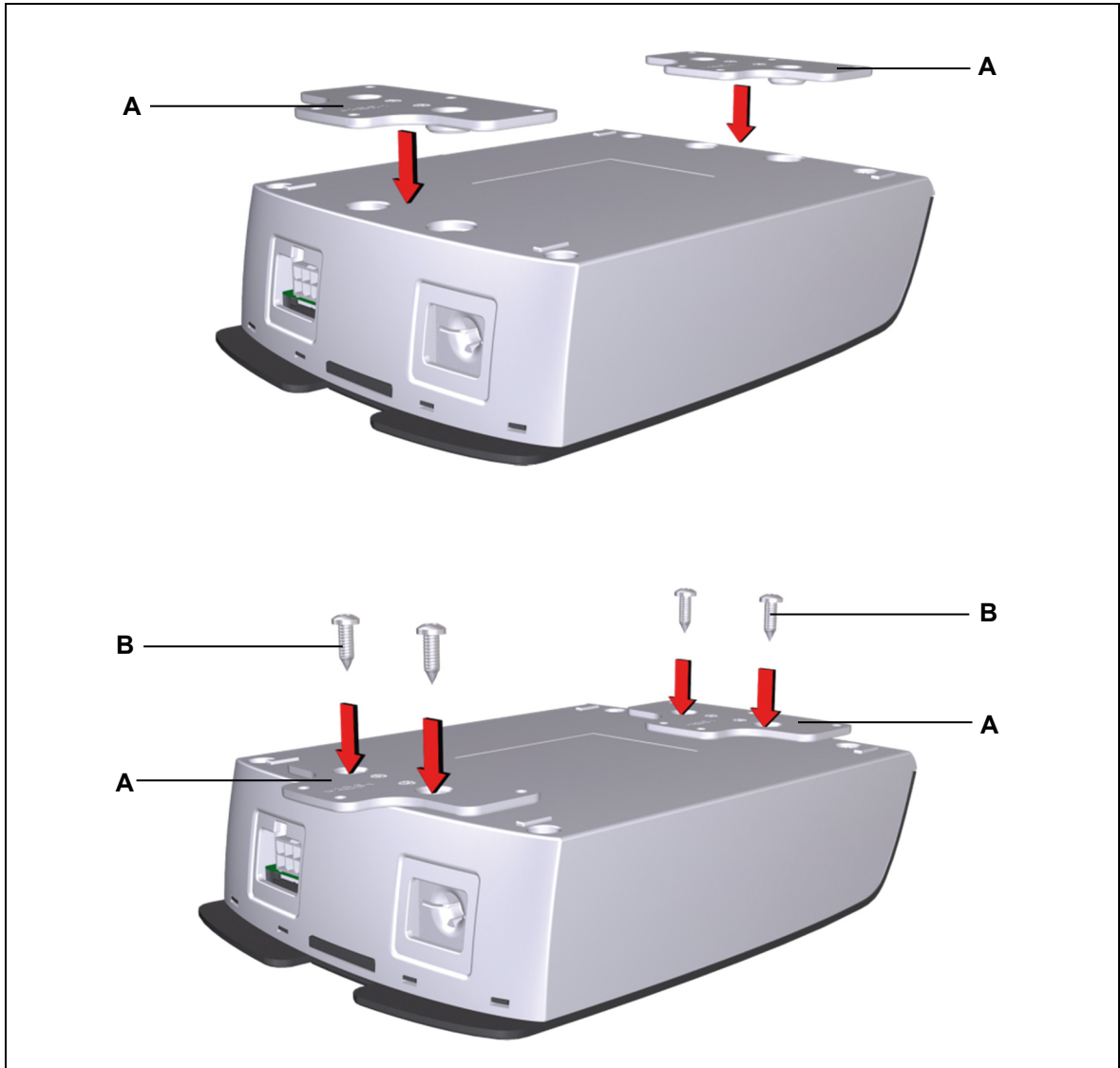

Figure 7 Attaching the mounting plates

A Mounting plates

B Screws

- 2 Tighten the screws on both mounting plates so the plates are firmly attached to the end product (as shown in Figure 8).

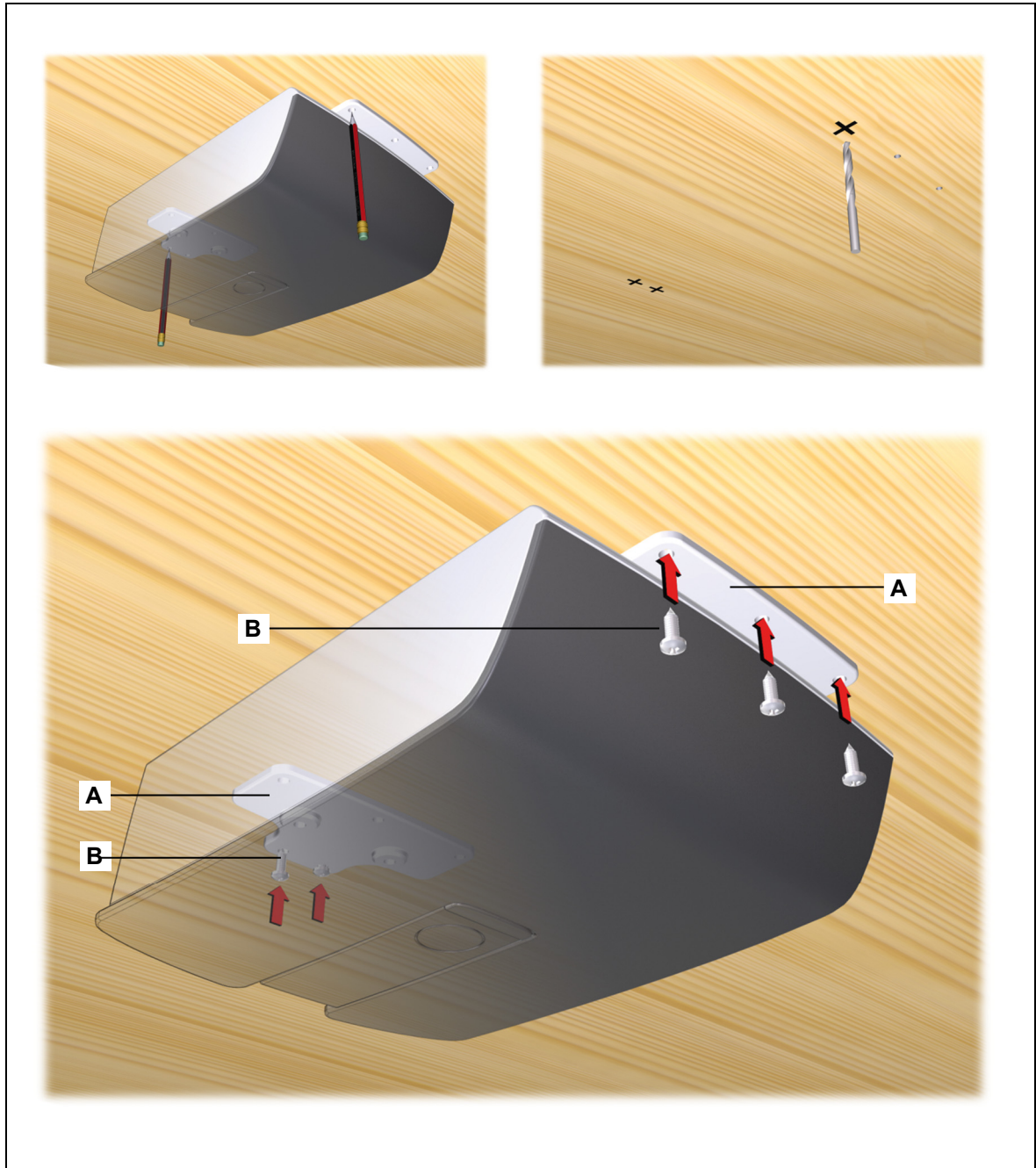

Figure 8 Mounting the HE-300 SMPS POWER SUPPLY to the end product

A Mounting plates

B Screws

5.2.2 Electrical connection



CAUTION

Electric shock

Electrical components should be connected or disconnected only when the power supply cord is unplugged.

- ▶ There is a delay after the supply voltage is applied before the device actually turns on. Wait at least seven seconds before beginning the commissioning.

Routing the electrical cables

When routing the cables, be sure that:

- the cables cannot get jammed,
- no mechanical load (such as pulling, pushing or bending) will be put on the cables, and
- the cables cannot be damaged in any way.

Fasten all cables (especially the connecting cables) to the end product using sufficient kink prevention methods. Be sure that the design of the end product prevents the connecting cables from coming into contact with the floor during transport.

Changing the batteries

The batteries are already connected when the unit is delivered. Replace the batteries after the reset function has been executed once. Both batteries should be replaced at the same time.

NOTICE

Both batteries should be replaced/inserted at the same time. Use batteries of similar:

- age,
- type and
- manufacturer.

- 1 Open the battery case cover on the side of the HE-300 SMPS POWER SUPPLY (press down on the catch clip, as shown in Figure 9).

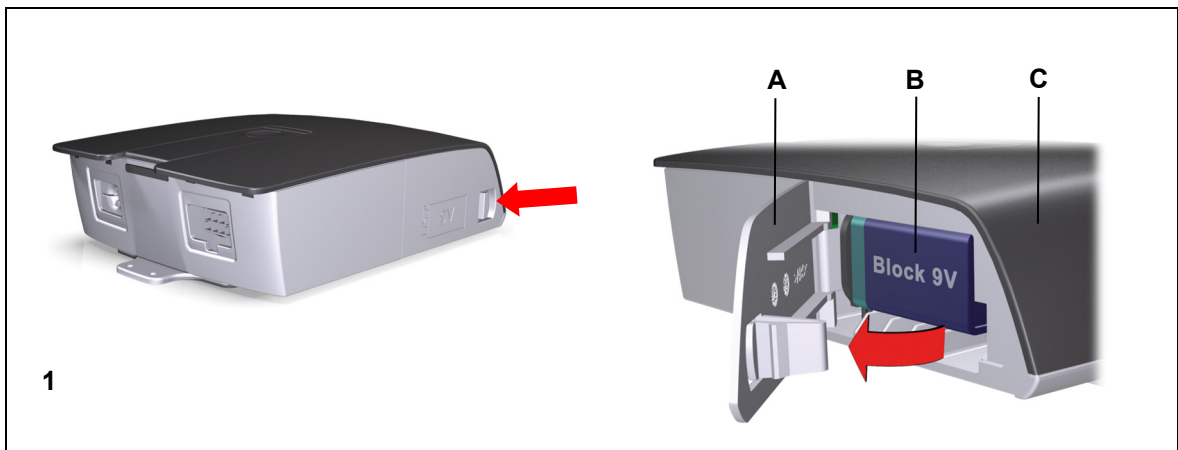

Figure 9 Opening the battery case cover

A Battery case cover

B Two nine-volt batteries (type 6LR61)

C HE-300 SMPS POWER SUPPLY

- 2 Remove both batteries and unplug the battery terminal clips.
- 3 Connect the two new batteries to the battery clips. Be sure not to reverse the polarity.
- 4 Insert the connected batteries into the battery compartment.
- 5 Close the battery cover; push on until it clicks into place.

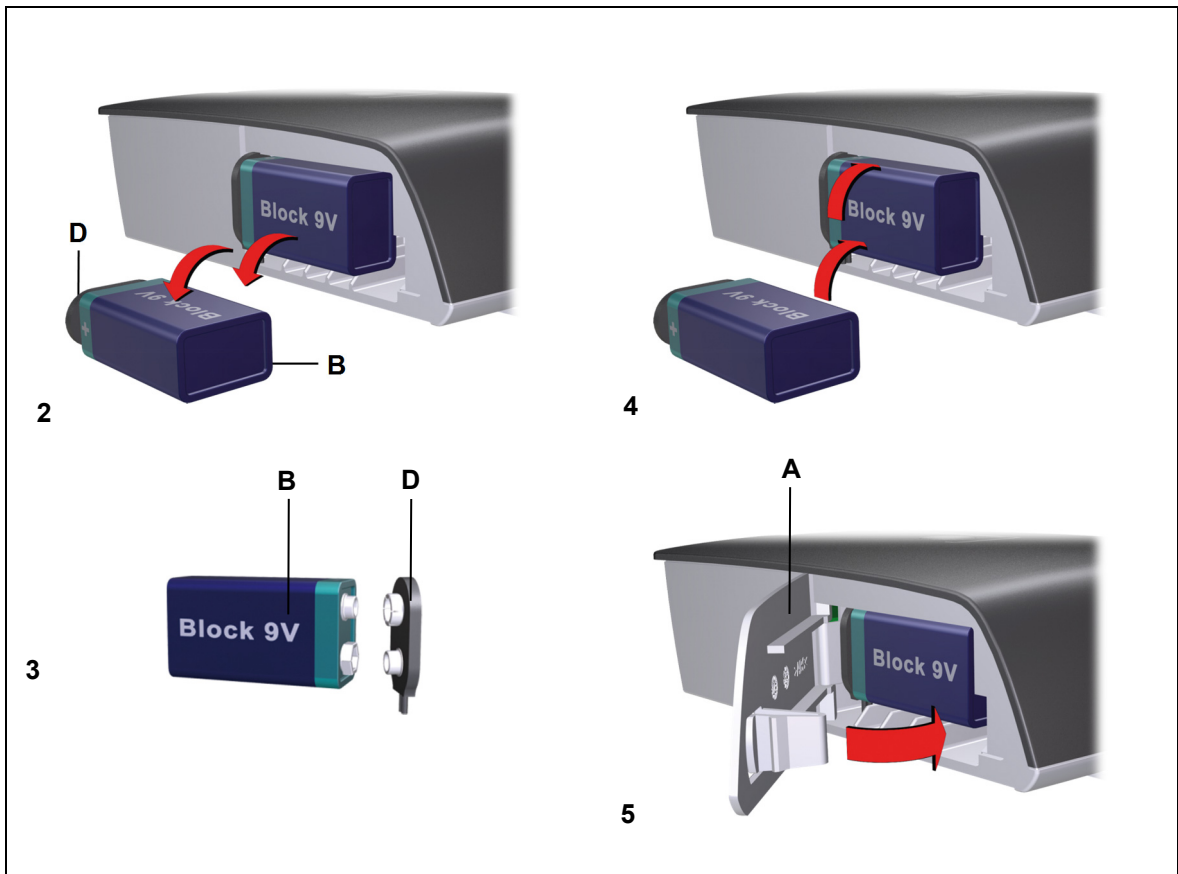

Figure 10 Connecting the batteries

- | | |
|-----------------------------------|-----------------------------------|
| A Battery case cover | B 9-V battery (type 6LR61) |
| C HE-300 SMPS POWER SUPPLY | D Battery clip |

⚠ CAUTION

The battery-operated reset function is not a safety system and does not avert danger.

5.2.3 Connections for the HE-300 SMPS POWER SUPPLY

- 1 Connect the HE-300 SMPS POWER SUPPLY to the DewertOkin control unit (e.g., the HE-300 or OKIMAT 8) as shown in Figure 11. Use the proper DewertOkin cable for this connection.
- 2 Insert the cable until you hear it snap in.
- 3 First plug the power cable into the HE-300 SMPS POWER SUPPLY and then into the wall socket.

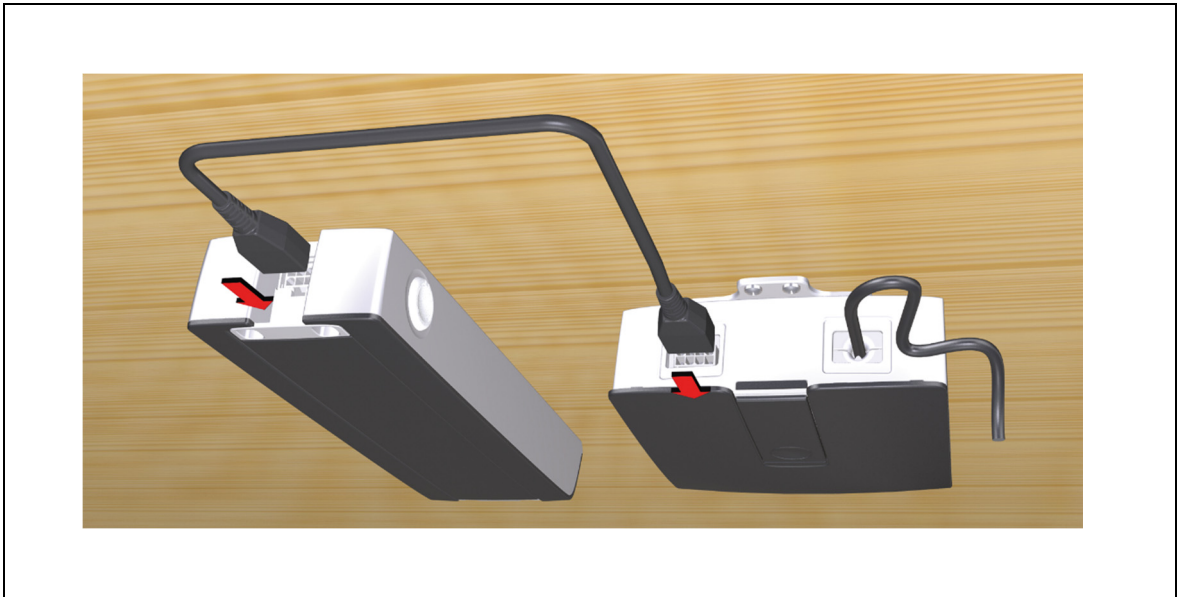

Figure 11 Example: Connecting the HE-300 SMPS POWER SUPPLY to the HE-300 CONTROL UNIT

5.2.4 Removing the HE-300 SMPS POWER SUPPLY

- 1 Disconnect the power cable from the wall socket.



CAUTION

You should only connect and disconnect the cables when they are completely disconnected from any live current!

- 2 Pull out the drive cable or the drive controller cable from the HE-300 SMPS POWER SUPPLY.

6. Information about creating your Operating Manual

The factual information contained within may be used when you are creating the end-product manual. The installation instructions do not contain all information required for the safe operation of the end product. They only describe the installation and operation of the HE-300 SMPS POWER SUPPLY as a partially assembled piece of machinery.

- ▶ When creating the operating instructions, remember that the installation instructions are intended for qualified specialists and are not for typical users of the end product.

6.1 General information

- ▶ Only drives and drive control units from DewertOkin should be connected to the HE-300 SMPS POWER SUPPLY, since they have already been verified to work together.

Delayed start-up

After plugging the power plug into the power outlet:

- ▶ There is a delay after the supply voltage is applied before the device actually turns on. Wait at least seven seconds before beginning the commissioning.

Avoiding electrical risks



CAUTION

Electric shock

Make sure that all live (current-carrying) parts of the drive system and power supply cannot be touched. In particular, be sure that unused power and control unit connections are covered adequately.



CAUTION

Risk of accident

Please follow these operating instructions carefully. You could be injured by fire or electrical shock if you do not follow these assembly instructions.



CAUTION

Only use the proper power cord that is permitted in your country. Be sure to use the correct plug adapter, as described in Figure 3.

Reducing the risk of overheating with the thermal monitor**CAUTION****Risk of accident**

The HE-300 SMPS POWER SUPPLY is equipped with a thermal fuse that triggers when the unit overheats. If the temperature control has triggered, remove the HE-300 SMPS POWER SUPPLY from the power supply, allow it to rest for 20 to 30 minutes and try again. If the unit still does not function, please contact your supplier or dealer.

Emergency shutoff of a connected drive or drive control unit

In an emergency, disconnect the power plug in order to shutoff the connected drive or drive control unit. The power plug must always be accessible during operations so that it is possible to shut down the drive or drive control unit at any time.

Avoiding cable damage

Be sure that your operating instructions inform the user about the possible cable risks.

**CAUTION****Risk of accident**

The cables (particularly the connecting cable) should not be run over. In order to prevent injuries or damage to the HE-300 SMPS POWER SUPPLY, no mechanical strain should be placed on the cables.

6.2 Battery-operated reset function

The battery-operated reset function allows the drive system to be operated using the function key during a power outage. Two nine-volt batteries are used to power the HE-300 SMPS POWER SUPPLY in the event of an outage. These batteries are connected at the factory. They can only be used to power the reset function once. The used batteries should then be replaced and properly disposed of.

NOTICE
The battery-operated reset function is not a safety system and does not avert danger.

- ▶ The batteries may only be used to power the reset function one time. Take out the batteries and dispose of them properly after the reset function has been carried out.
- ▶ If the end product is under a heavy load which prevents the reset function from operating, the strain or load on the end product must first be removed before a reset can be carried out.
- ▶ More information on connecting the batteries can be found in the "Changing the batteries" section on page 19.

7. Troubleshooting

This chapter describes troubleshooting methods for fixing problems. If you experience an error that is not listed in this table, please contact your supplier.

- ▶ Only qualified specialists who have received electrician training should carry out troubleshooting and repairs.

Problem	Possible cause	Solution
The drive or drive control unit is not functioning.	There is no mains supply voltage.	Connect the mains power.
	The drive or drive control unit is defective.	Please contact your supplier or sales agent.
The drive is suddenly not capable of movement.	The overheating protection or system protection has been triggered.	Remove the overload (change or remove the load). Allow the system to rest for 20 to 30 minutes with the mains power unplugged. If this does not resolve the problem, contact your supplier or distributor.
	The unit's fuse may have been triggered.	Please contact your supplier or sales agent.
	There is no mains supply voltage.	Connect the mains power.
	A lead-in connection has been interrupted (mains power, auxiliary drive or handset).	Check the cables and reinsert them, if required.
Battery-operated reset does not function.	Battery is empty.	Check the batteries and replace if necessary.
	Battery is not connected.	Connect the batteries.

8. Maintenance and cleaning

8.1 Maintenance

The HE-300 SMPS POWER SUPPLY requires no maintenance.

8.2 Cleaning and care

- ▶ Clean the HE-300 SMPS POWER SUPPLY as needed using a dry cloth.

NOTICE

- Always disconnect the mains power plug before you start to clean the drive!
- Never clean the HE-300 SMPS POWER SUPPLY in an automated washing system or with a high-pressure cleaner. Do not allow fluids to penetrate into the unit. Damage to the system could result.
- Do not use a cleanser that contains benzene, alcohol or similar solvents.
- Make sure that you do not damage the drive's connecting cable.

9. Disposal

9.1 Packaging material

The packaging material should be sorted into recyclable components and then disposed of in accordance with the appropriate national environmental regulations (in Germany according to the recycling law KrWG from 01.06.2012; internationally according to the EU Directive 2008/98/EC (Waste Framework Directive WFD as of 12.12.2008)).

9.2 Components of the external power supply unit

The HE-300 SMPS POWER SUPPLY consists of electronic components, cables and metal and plastic parts. You should observe all corresponding national and regional environmental regulations when disposing of the system.

The disposal of the end product is regulated in Germany by Elektro-G, internationally by the EU Directive 2012/19/EC (WEEE), or by any applicable national laws and regulations.



The HE-300 SMPS POWER SUPPLY should not be disposed of with normal household waste!

The disposal of the nine-volt batteries is regulated in the EU by Battery Directive 2006/66/EC, in Germany by the BattG battery law of 25.6.2009, and internationally by any applicable national laws and regulations.



The nine-volt batteries should not be disposed of with normal household waste!

EG-Konformitätserklärung

Nach Anhang IV der EMV-Richtlinie 2014/30/EU

Nach Anhang IV der EU-Niederspannungsrichtlinie 2014/35/EU

Nach Anhang VI der RoHS-Richtlinie 2011/65/EU (inkl. Delegierte Richtlinie (EU) 2015/863)

Der Hersteller

EU Declaration of Conformity

In compliance with Appendix IV of the EMC-Directive 2014/30/EU

In compliance with Appendix IV of the LVD-Directive 2014/35/EU

In compliance with Appendix VI of the EU RoHS Directive 2011/65/EU (incl. Commission delegated Directive (EU) 2015/863)

The manufacturer

DewertOkin GmbH
Weststraße 1
32278 Kirchlegern
Deutschland - Germany

erklärt hiermit, dass das Produkt

declares that the following product

POWER SUPPLY HE-300 SMPS

mit DewertOkin Steuerung / with DewertOkin Control unit

die Anforderungen folgender EG-Richtlinien erfüllt:

meets the requirements of the following EU directives:

Richtlinie über elektromagnetische Verträglichkeit 2014/30/EU

Electromagnetic Compatibility Directive 2014/30/EU

Niederspannungsrichtlinie 2014/35/EU

Low Voltage Directive 2014/35/EU

DELEGIERTE RICHTLINIE (EU) 2015/863 DER KOMMISSION vom 31. März 2015 zur Änderung von Anhang II der Richtlinie 2011/65/EU des Europäischen Parlaments und des Rates hinsichtlich der Liste der Stoffe, die Beschränkungen unterliegen.

COMMISSION DELEGATED DIRECTIVE (EU) 2015/863 of 31 March 2015 amending Annex II to Directive 2011/65/EU of the European Parliament and of the Council as regards the list of restricted substances.

Angewendete Normen

Applied standards:

- EN 60335-1:2012/A11:2014
- EN 55014-1:2006/A1:2009/A2:2011
- EN 55014-2:1997/A1:2001/A2:2008
- EN 61000-3-2:2014
- EN 61000-3-3:2013
- EN 62233:2008
- EN 50581:2012

Konstruktive Änderungen, die Auswirkungen auf die in der Montageanleitung angegebenen technischen Daten und den bestimmungsgemäßen Gebrauch haben, das Produkt also wesentlich verändern, machen diese Konformitätserklärung ungültig!

This declaration of conformity is no longer valid if constructional changes are made which significantly change the drive system (i.e., which influence the technical specifications found in the instructions or the intended use)!

Kirchlegern, Germany 25 November 2019



Dr.-Ing. Josef G. Groß
Geschäftsführer / Managing Director

Additional information

HE-300 SMPS POWER SUPPLY

Power cable recommended for use outside of the USA and Canada:

Power cable (refer to IEC/EN 61558-1)				
Flexible cord type	Conductor (wire) cross-section	Number of conductors	Cord length	
			Minimum	Maximum
H05VV-F, H05VVH2-F, H05RR-F	0.75 mm ²	2	2 m	4 m

DewertOkin GmbH
Weststrasse 1
Kirchlengern 32278, Germany
Tel: +49(0)5223/979-0
Fax.: +49 0 522375182
<http://www.dewertokin.de>
Info@dewertokin.de

ID No.: 79825