

Installation Instructions

(Translation of the original installation instructions)



System ID21

Document revision history

Version	Date	Modification, change
(-)	07/2011	First release
(a)	05/2015	Control keypads, control units

Disclaimer and exclusion of liability

DewertOkin is not responsible for damage resulting from:

- failure to observe these instructions,
- changes made to this product which have not been approved by DewertOkin, or
- the use of replacement parts which have not been approved or manufactured by DewertOkin.

► We reserve the right to make unannounced technical changes in the course of our continual product improvement process!

Creation of a complete operating instruction manual for the entire end product

These instructions are only intended to be used by the end-product manufacturer. They should not be given to the operator of the end product. The factual information contained within may be used as a basis when creating the end-product manual.

The warning and danger notices are best suited for use in the end product's manual. However it is not sufficient to simply follow these notices. You should also carry out an internal risk assessment for your end product. This can then be used as the basis for the safety notices in your manual.

These installation instructions do not contain all information required to safely operate the end product. They only describe the installation and operation of the drive as partially completed machinery.

The instructions are intended for the technicians responsible for manufacturing an end product and not for the operators of the end product.

Document revision history	3
Disclaimer and exclusion of liability.....	3
Creation of a complete operating instruction manual for the entire end product.....	3
1. General Information.....	6
1.1 Safety notices within the installation instruction and the operating instructions for the entire machine	7
1.2 Conventions used	7
2. Safety notices	8
2.1 Proper and intended usage.....	8
2.2 Selection and qualification of personnel	9
3. System component description	10
3.1 Complete installed DESKFRAME system.....	10
3.2 SMART and COMPACT control units	11
3.3 Control keypads	13
3.4 ID21 lifting column	18
4. Configuration options for the ID21 system	19
5. Installation.....	20
5.1 Safety notices to observe during installation	20
5.2 Installing the ID21 lifting columns.....	22
5.3 Installing the control keypads.....	26
5.4 Installing the SMART/COMPACT control units	31
5.5 Electrical connections for the SMART/COMPACT control units.....	34
5.6 Mounting the sensor unit	36
6. Initial commissioning.....	40
6.1 Reset during commissioning.....	40
7. Notes for operation.....	41
7.1 General information	41
8. Operating the control keypads	43
8.1 Functions of the Motion Assist control keypad	43
8.2 Functions of the HSCO control keypad	44

8.3	Functions of the HSU Varioline control keypad.....	45
8.4	Functions of the HSU control keypad	46
8.5	Functions of the HSF control keypad	48
8.6	Functions of the Touch basic IL control keypad	51
8.7	Functions of the Touch basic DN control keypad	52
9.	Troubleshooting	53
9.1	Malfunctions	53
9.2	Error messages on the control keypad's display	54
9.3	Error messages, as indicated by clicking tones from the control unit	57
9.4	Error messages displayed by the LEDs (COMPACT control unit).....	57
10.	Maintenance and cleaning	58
10.1	Maintenance.....	58
10.2	Cleaning	58
11.	Technical specifications and product designation.....	59
11.1	Table	59
11.2	SMART and COMPACT control units	60
11.3	Size of SMART control unit	61
11.4	Size of COMPACT control unit.....	62
11.5	ID21 lifting column	63
11.6	Size of the ID21 lifting column	64
11.7	Product labelling	65
12.	Disposal.....	70
12.1	Packaging material.....	70
12.2	Drive components	70
	Declaration of incorporation/installation	71
	EU Declaration of Conformity	72

1. General Information

These installation instructions are not specific operating instructions for the end product. Rather, they describe the functions of the control keypads and the installation of the ID21 system components:

- ID21 lifting columns,
- Control keypads,
- SMART and COMPACT control units.

These instructions will help you to minimize danger, repair costs and down times. They will also help you to maximize the reliability and lifespan of the end product.

NOTICE

The instructions for installing the ID21 system should also be followed.

 **CAUTION**

The notices in these instructions must be followed! Following the guidelines during installation and connection procedures will help to minimize:

- the risk of accident and injury, and
- damage to the drive system or the end product.

These installation instructions have been written with due care and attention. However, we cannot guarantee that the data, images and drawings are complete and correct nor do we accept any liability for the information contained therein, unless required by law.

- ▶ We reserve the right to make unannounced technical changes in the course of our continual product improvement process!

Availability of this document

As manufacturer of the end product, you are obligated to comply with Machinery Directive 2006/42/EC. This directive stipulates that the installation instructions must be kept on file for governmental inspection purposes.

Keep these instructions in a safe place!

Application

These testing principles apply towards the testing and certification of sitting/standing desks used for office, meeting, conference and training rooms. The work tables can be adjusted and used for both sitting and standing work conditions.

1.1 Safety notices within the installation instruction and the operating instructions for the entire machine

The manufacturer of the complete machine (the end product) is only permitted to operate the ID21 lifting columns (by itself an incomplete machine)

- when the end product (for which the ID21 lifting columns are intended) is in compliance with all protective measures specified in the Machinery Directive 2006/42/EC, and
- when the manufacturer expressly declares the compliance of the end product.

The manufacturer of the end product must create a manual for the users of that product. The safety notices in the end-product manual must be written based on the end product's risk assessment.

1.2 Conventions used

Notices which do not relate to safety are indicated in these instructions with a symbol:

- ▶ Triangular notice symbol

Explanations of warning notices

 CAUTION
--

CAUTION indicates a hazardous situation which, if not avoided, could result in minor or moderate injury.
--

NOTICE

NOTICE is used to address practices which are not related to personal injury but may result in damage to the product or surroundings.

2. Safety notices

2.1 Proper and intended usage

The ID21 system is intended to be used

- for adjusting the height of tables in conjunction with the SMART/COMPACT control units and the ID21 lifting columns from DewertOkin.

It may only be used for applications where unintended motion cannot lead to damage.

It may only be used in dry rooms.

DESKFRAME:

This height-adjustable table (without tabletop*) for office work is designed for working:

- while sitting,
- sitting and standing or
- only standing.

(When the tabletop is also installed: type A, EN527-1.)

CAUTION

Risk of accident

The ID21 system should only be used for the purpose described above. Any other use is forbidden. Improper usage can lead to accidents or destruction of the unit. Such non-approved applications will lead immediately to the expiration of all guarantee and warranty claims on the part of the end-product manufacturer against the manufacturer.

Improper usage

Be sure to follow the notices below concerning improper usage. You should include them in your product manual in order to inform the users of your end product.

The ID21 system should not be used:

- with a medical product, or installed in a medical product,
- as a power source for toys or games,
- for raising and lowering loads in industrial or technical applications.
- in a moist environment, or
- outdoors,
- for industrial applications.

The ID21 system can be used by children of 8 years and older, persons with reduced physical, sensory or mental capabilities, or persons with lack of experience or knowledge when they are supervised or instructed concerning the safe use of the device and when they understand the resulting risks. Do not allow children to play with this device. The cleaning and user maintenance must not be carried out by children without supervision.

* The tabletop will be provided and installed by the manufacturer of the end product.

- ▶ You should only use spare parts which have been manufactured or approved by DewertO-kin. Only these parts will guarantee a sufficient level of safety.

**CAUTION****Danger of crushing injury!**

There is a danger of being crushed when the table position is changed. This is particularly true when there is no protective mechanism guarding against crushing injuries. However, crushing injuries may even occur in exceptional cases when a safety guard is installed. Make sure that there are no persons within the danger zone and that nobody reaches into the danger zone. This also applies in the following situations:

- In the event of a malfunction, the table may move a bit during an adjustment before the safety shutdown mechanism triggers. This could result in a crushing injury.
- The impact protection mechanism is not active during resets and end-position queries. This could result in a crushing injury.

2.2 Selection and qualification of personnel

This ID21 system should only be installed into the end product by someone who has completed training in electronic motor assembly or has equivalent qualifications.

You should only install this into the end product if you are qualified to do so. Otherwise, a properly qualified person should be found for this task.

3. System component description

The ID21 system uses lifting columns to adjust the height of tables. A table-mounted control keypad and the SMART/COMPACT control units can be used for the adjustments.

The ID21 system variants can differ by:

- the type of control keypads,
- the number of lifting columns that can be connected,
- the type and number of control units connected.

3.1 Complete installed DESKFRAME system

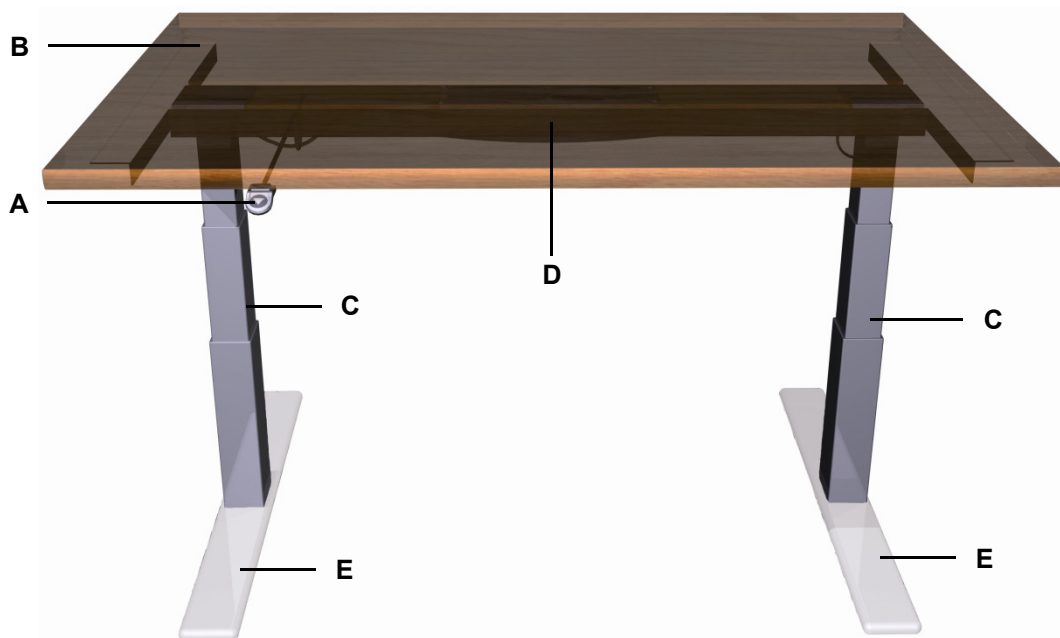

Figure 1 Example: ID21 system with two lifting columns

- | | |
|------------------------------|---|
| A Control keypad | B Tabletop |
| C ID21 lifting column | D SMART or COMPACT control units |
| E Table base | |

3.1.1 Dimensions

Specifications for the installed system:

- Max. lengthwise extension: 1300 – 2000 mm
- Max. transverse extension: 800 – 1000 mm
- Tabletop size: 2000 x 800 mm must not be exceeded
- Max. load on the frame: 100 kg (the weight of the tabletop has to be considered here)
- Lifespan: max. 10,000 cycles (with load)

3.2 SMART and COMPACT control units

The SMART and COMPACT control units have an enclosure with connections for the power supply, lifting columns, and for the control keypad.

3.2.1 SMART control unit

The SMART control unit is used for adjusting one or two lifting columns.

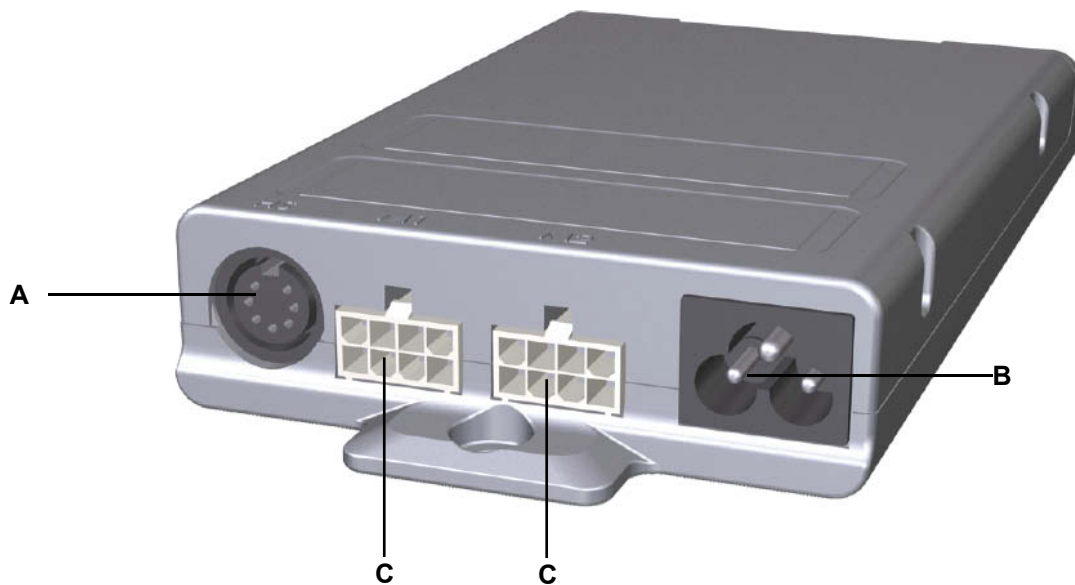

Figure 2 SMART control unit

A Connection for the control keypad

B Mains power supply connection

C Connection for the lifting column

3.2.2 COMPACT control unit

The COMPACT control unit is used for adjusting one, two or three lifting columns.

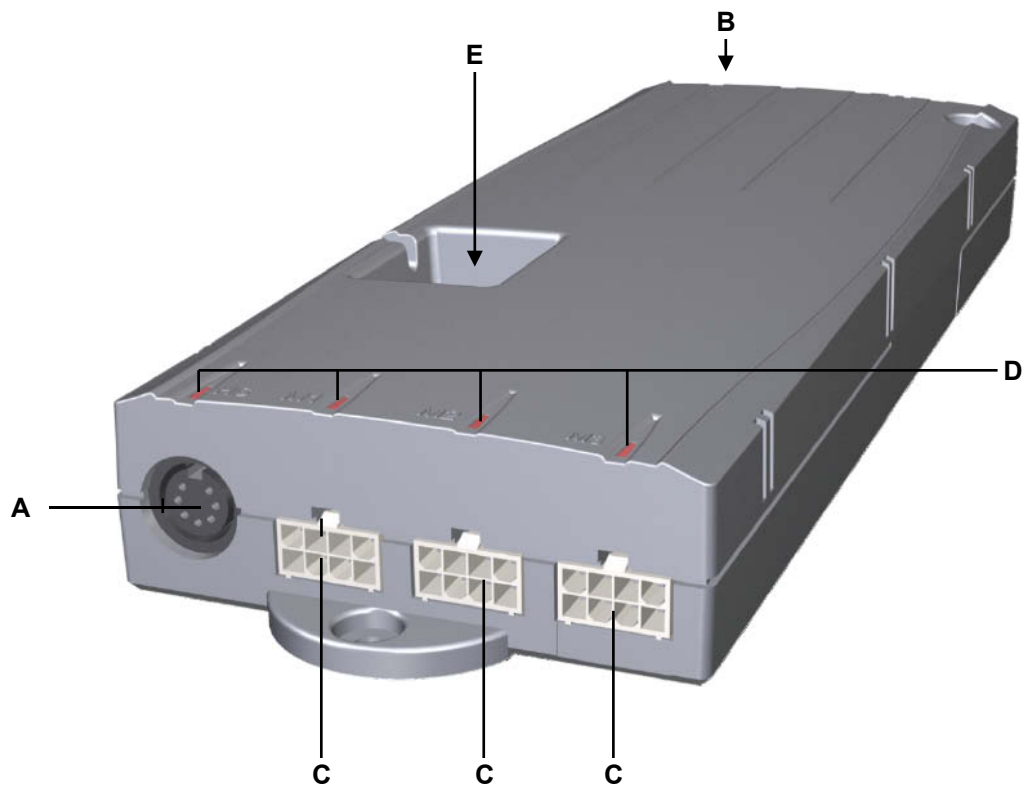

Figure 3 COMPACT control unit

A Connection for the control keypad
C Connection for the lifting column
E Sensor connection / cascade connection

B Mains power supply connection
D Status LEDs

3.3 Control keypads

The control keypads are used to adjust the table height, to save positions (optional), and to adjust motor group 2. The table positions and optional saved (programmed) positions can be moved to directly.

3.3.1 Motion Assist control keypad

The Motion Assist control keypad has two keys for the up and down adjustments.



Figure 4 Motion Assist control keypad

- | | |
|---------------------------------|-------------------------------|
| A ▼ key (adjusting down) | B Mounting surface |
| C Connection cable | D ▲ key (adjusting up) |

3.3.2 HSCO control keypad

The HSCO control keypad has two keys for the up and down adjustments.

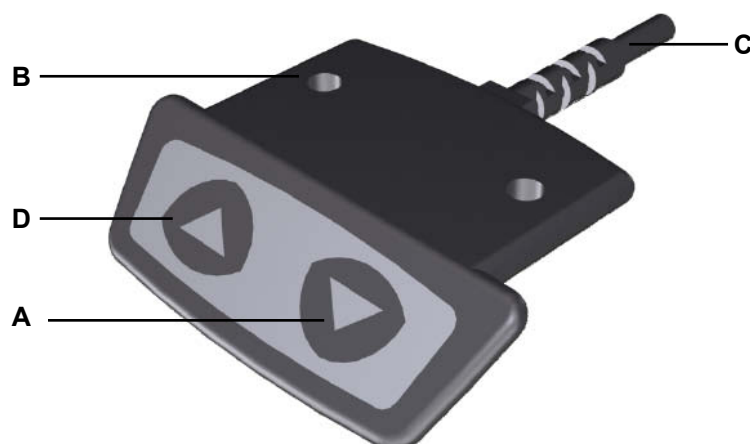

Figure 5 HSCO control keypad

- | | |
|---------------------------------|-------------------------------|
| A ▼ key (adjusting down) | B Mounting surface |
| C Connection cable | D ▲ key (adjusting up) |

3.3.3 HSU Varioline control keypad

The HSU Varioline control keypad has two keys for the up and down adjustments.

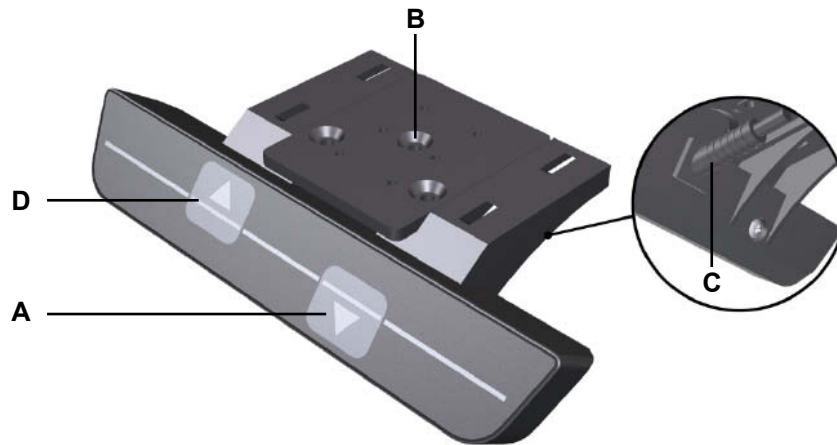



Figure 6 HSU Varioline control keypad

A  key (adjusting down)

B Mounting surface

C Connection cable

D  key (adjusting up)

3.3.4 HSU control keypad

The HSU control keypad has two keys for the up/down adjustment movements, four memory keys, a save key and a display.

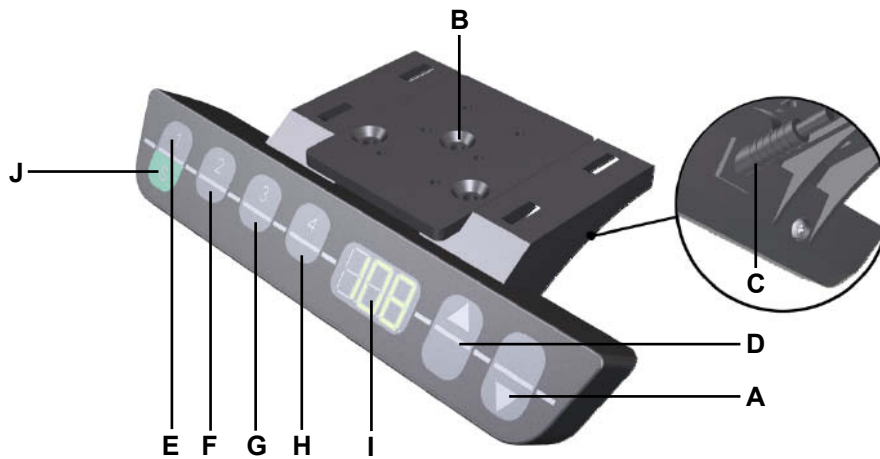









Figure 7 HSU control keypad

- | | |
|---|---|
| A  key (adjusting down) | B Mounting surface |
| C Connection cable | D  key (adjusting up) |
| E  memory key 1 | F  memory key 2 |
| G  memory key 3 | H  memory key 4 |
| I Display | J  save key |

3.3.5 HSF control keypad

The HSF control keypad has two keys for the up/down adjustment movements, four memory keys, two keys for motor group 2, a save key and a display.

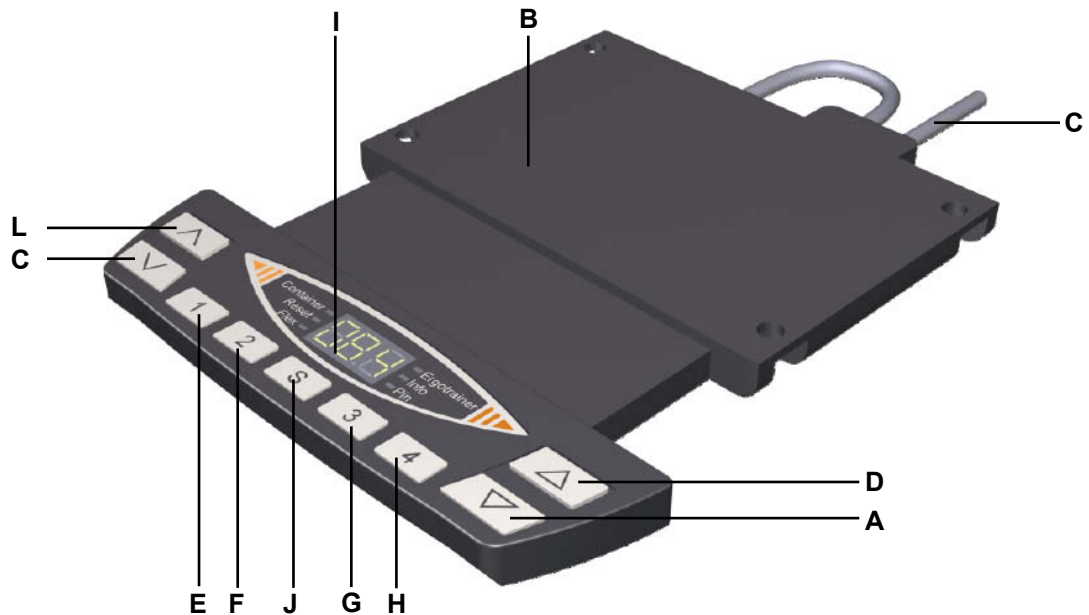











Figure 8 HSF control keypad

- | | |
|---|---|
| A  key (adjusting down) | B Mounting surface |
| C Connection cable | D  key (adjusting up) |
| E  memory key 1 | F  memory key 2 |
| G  memory key 3 | H  memory key 4 |
| I Display | J  save key |
| K  motor group 2, adjust downward | L  motor group 2, adjust upward |

3.3.6 Touch basic IL control keypad

The Touch basic IL control keypad has two keys for the up and down adjustments.



Figure 9 Touch basic IL control keypad

A  key (adjusting down)

D  key (adjusting up)

3.3.7 Touch basic DN control keypad

The Touch basic DN control keypad has two keys for the up and down adjustments.



Figure 10 Touch basic DN control keypad

A  key (adjusting down)

B Mounting surface

C Connection cable

D  key (adjusting up)

3.4 ID21 lifting column

The main components of the ID21 lifting column are the electric motor, the telescopic columns for adjustments, the outer support column, and the control cable. The end product will be attached to the head of the lifting column. The foot base is attached to the foot end of the lifting column. Positional sensors are built in to allow for synchronized adjustments with multiple columns.

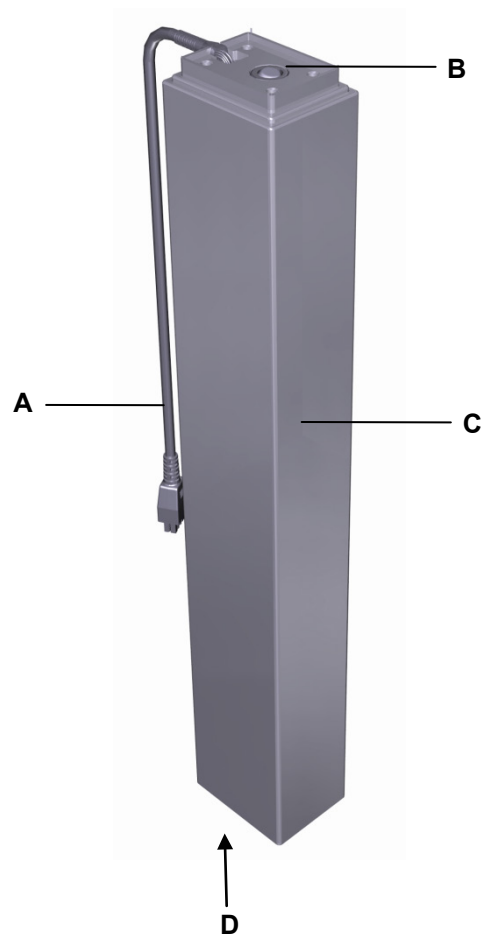

Figure 11 Major components of the ID21 lifting column

- | | |
|--|-------------------------------------|
| A Connection cable | B Head of the lifting column |
| C Outer support column with two internal telescopic columns | D Foot of the lifting column |

4. Configuration options for the ID21 system

Depending on the particular configuration, the ID21 system can be combined with up to three lifting columns. The configurations with two and three lifting columns are described below:

Configuration 1:

SMART control unit with one or two ID21 lifting columns and a control keypad

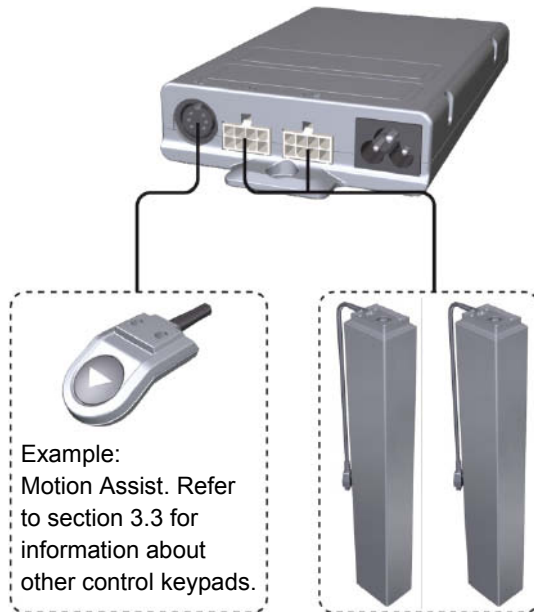

Installation steps:

- Install the lifting columns (see section 5.2, page 22)
- Install the control keypad (see section 5.3, page 26)
- Install the SMART control unit (see section 5.4, page 31)
- Connect the control keypad and the lifting columns to the control unit (see section 5.5.1, page 34)
- Connect the power supply cable (see section 5.5.1, page 34)

Configuration 2:

COMPACT control unit with one, two or three ID21 lifting columns and a control keypad

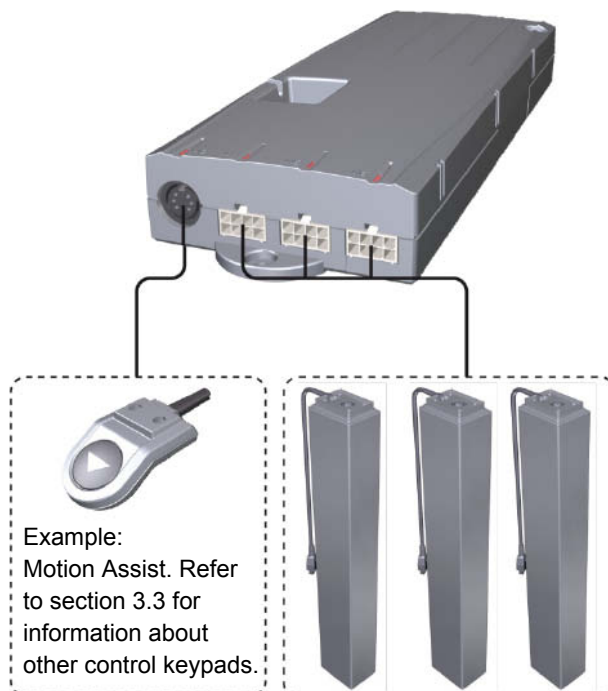

Installation steps:

- Install the lifting columns (see section 5.2, page 22)
- Install the control keypad (see section 5.3, page 26)
- Install the COMPACT control unit (see section 5.4, page 31)
- Connect the control keypad and the lifting columns to the control unit (see section 5.5.2, page 35)
- Connect the power supply cable (see section 5.5.2, page 35)

5. Installation

5.1 Safety notices to observe during installation

Basic safety rules must be followed in order to ensure that the end product can be continually operated in a safe manner. These rules must be observed while using the end product and while installing the SMART/COMPACT control unit, the control keypad, the ID21 lifting columns, and the slave drive in the end product.

Avoiding electrical faults

Be sure to consider the length of the power cord when designing the dimensions for your end product in order to minimize the associated risks.

Routing the electrical cables

When routing the cables, be sure that:

- the cables cannot get jammed,
- no mechanical load (such as pulling, pushing or bending) will be put on the cables, and
- the cables cannot be damaged in any way.

Fasten all cables using sufficient strain relief and kink prevention methods.

5.1.1 Reliability

The safety and reliability of the end product containing DewertOkin components can be ensured by using the proper construction methods as described below.

Overheating

A thermal monitor switches the SMART/COMPACT control unit off if it overheats.

CAUTION

The SMART/COMPACT control unit is equipped with a thermal monitor (circuit breaker) that triggers when the unit overheats. If the temperature control has triggered, remove the control unit from the power supply, allow it to rest for 20 to 30 minutes and try again. If the control unit still does not function, please contact your supplier or sales agent.

Avoiding fatigue fractures

- Install the lifting column in the end product so that it is properly aligned. This will help prevent shear stress.
- Do not position the lifting column at a slanted angle when installing it in the end product. A slanted angle between the intended direction of movement of the end product and the lifting column's direction will create shear stress and could lead to a fatigue fracture.

Avoiding a pinching hazard

When designing your end product, you should take the lifting column's adjustment movement into account with passive safety mechanisms and with the appropriate safety notices in your operating instructions.

- Installation methods for ensuring passive safety: Install the ID21 lifting column so that none of the positions where shear and pinch hazards exist are accessible externally.
- ▶ Make sure that your operating instructions inform the user of these safety points.
- ▶ Structural modifications and improper installation which do not follow the installation steps or the safety instructions found in these installation instructions may result in serious injuries to users (e.g. crushing injuries). Structural modifications may only be made after consulting with DewertOkin and receiving our consent. Follow all instructions from DewertOkin, especially those found in these installation instructions.

NOTICE

Compliance with the intended usage and other regulations

Any further processing of the products that contradicts the proper and intended usage is forbidden.

The manufacturer or installer of the end product must ensure that all legal and regulatory requirements regarding the end product's manufacture, installation and customer support are followed.

5.1.2 Selecting the tabletop

The DIN Technical Report 147 describes the following information:

- Corner and edge design
- Exterior surfaces
- Surface brightness
- Surface finish
- Min. 3 mm edge radius

This information shall be considered binding when selecting the tabletop.

5.1.3 Ergonomics

The operating instructions that you are creating for the end product must provide instructions for an ergonomically correct installation where the control keypads are easily accessible and the table is freely accessible.

5.1.4 Use of the system by the end customer

The operating instructions for the end customer must refer to standards regarding:

- Standards for usage, arrangement of equipment in the working area, the planned activities and the working postures and positions
- Standards for describing the adjustment mechanisms with instructions for ergonomic adjustments

Please refer to the guidelines for the design of screens and office workstations from the German Trade Association for Printing and Paper Processing (BGI 650).

5.2 Installing the ID21 lifting columns

Before installing and connecting the ID21 lifting columns, make sure that you are observing all of the safety notices found in the "Safety notices to observe during installation" section.

5.2.1 Assembly table stand

- Use M6 screws (grade 8.8) of suitable length so that the screw-in depth is between 9 and 11 mm, as shown in Figure 12 (screw length = thickness of the base plate + min. 9 to max. 11 mm). The tightening torque must not exceed 10 Nm.

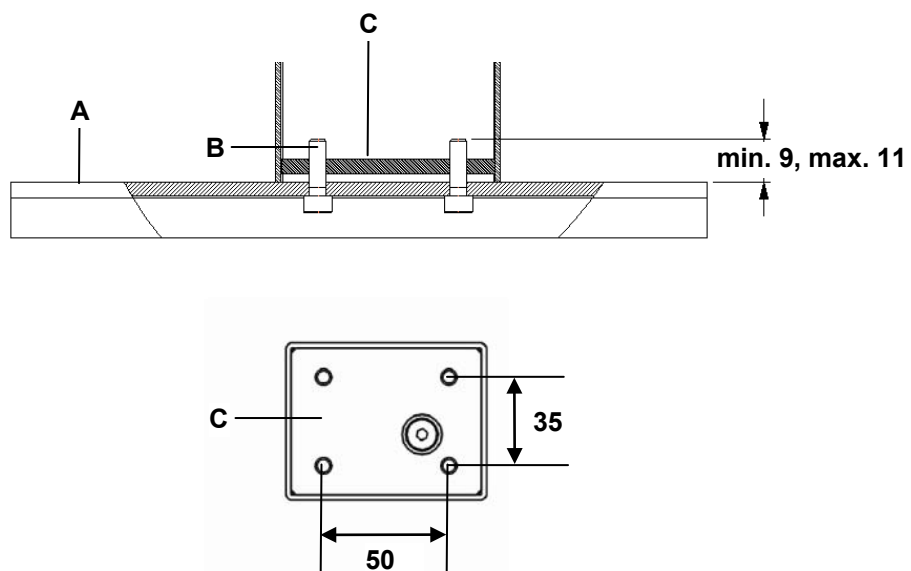

Figure 12 Mounting the table base (dimensions in mm)

A Base plate

B M6 screws (8.8)

C Foot of the lifting column

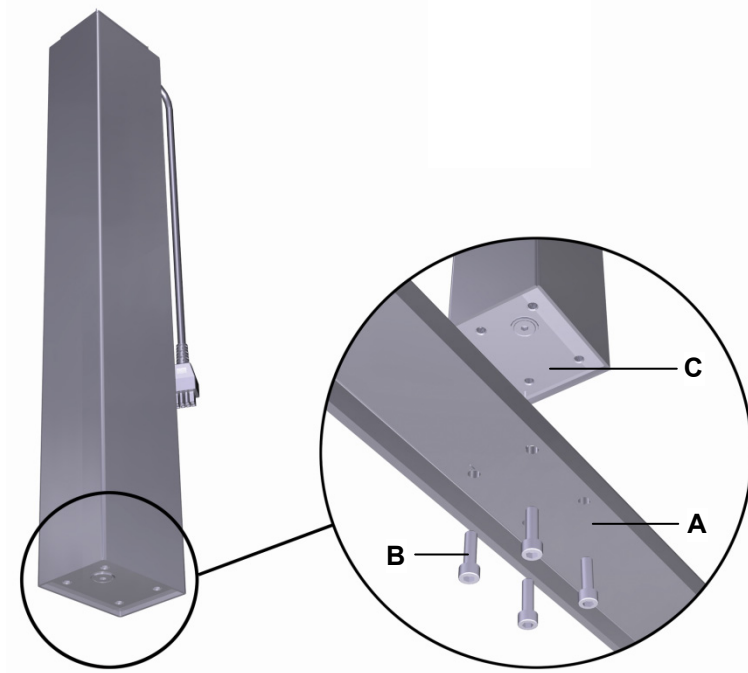

Figure 13 Mounting the table base

A Base plate

B M6 screws (8.8)

C Foot of the lifting column

- 1 Use four screws to attach the table base to the foot end of the ID21 lifting column, as shown in Figure 13 (maximum tightening torque is 10 Nm). The mounting dimensions are shown in Figure 12.
- 2 Repeat step 1 with all other lifting columns.

5.2.2 Mounting the table frame

- ▶ Use M6 screws (grade 8.8) of suitable length so that the depth is at least 9 mm and a maximum of 11 mm, as shown in Figure 14 (screw length = thickness of the mounting plate + min. 9 to max. 11 mm). The tightening torque must not exceed 10 Nm.

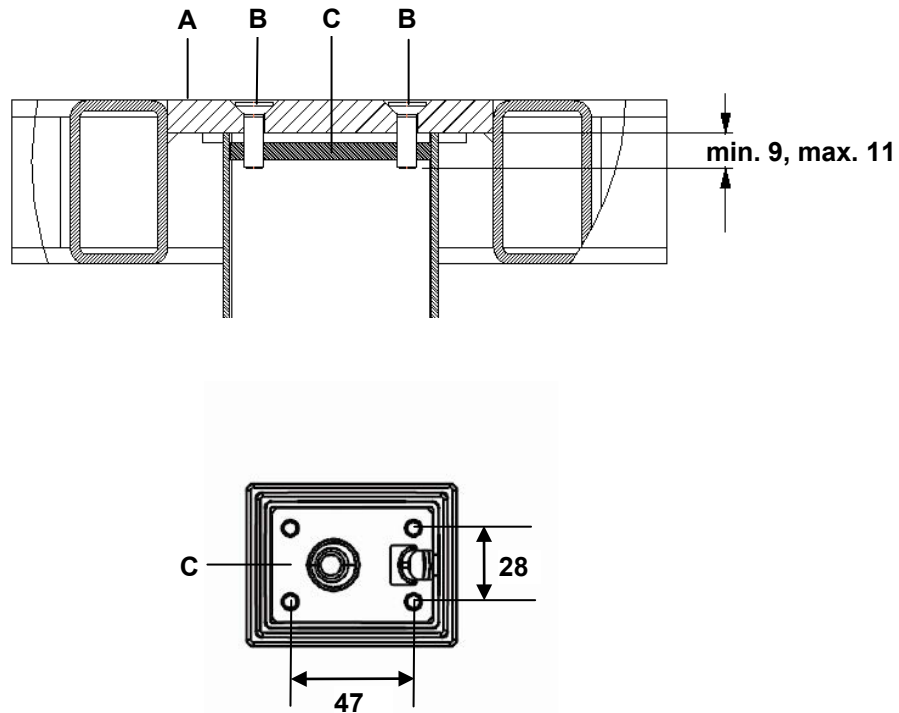

Figure 14 Mounting the table frame (dimensions in mm)

A Table frame

B M6 screws (grade 8.8)

C Head of the lifting column

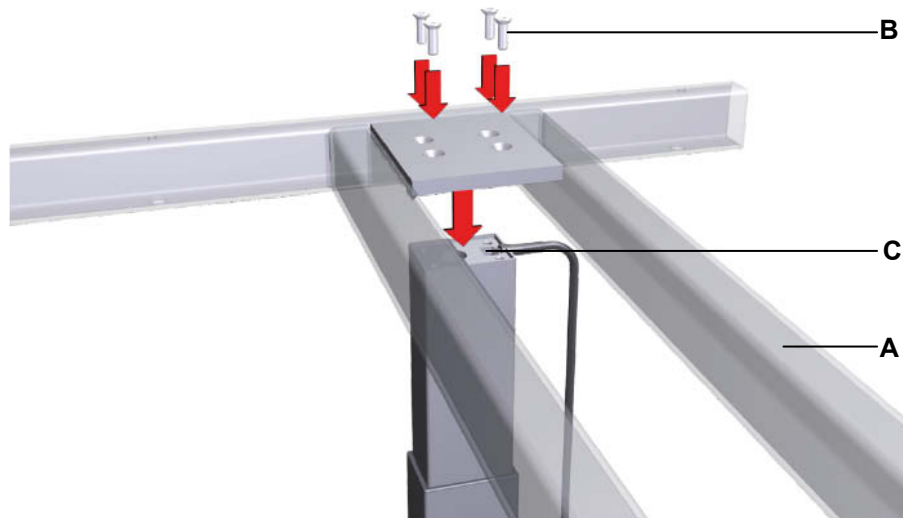

Figure 15 Mounting the table frame

A End product (e.g. a table frame)

B M6 screws (grade 8.8)

C Head of the lifting column

- 1 Set the table frame so that the holes are over the lifting column. Use four screws to attach the table frame to the head end of the ID21 lifting column, as shown in Figure 15 (maximum tightening torque is 10 Nm). The mounting dimensions are shown in Figure 14.
- 2 Screw the other lifting columns to the table frame.

5.2.3 Dismantling the lifting column

CAUTION

Work on electrical components should be conducted only when the mains power connection for the control unit is unplugged.

- 1 Move the table to the starting position, so that the lifting columns are fully retracted.
- 2 Pull out the control unit's mains power plug!
- 3 Remove all of the lifting columns' cables from the sockets of the control unit.
- 4 Remove all lifting columns from the table frame.

5.3 Installing the control keypads

NOTICE

The control keypad must be installed in an ergonomically correct position so that the user can reach it easily.

NOTICE

Please observe the thickness of the tabletop.

5.3.1 Motion Assist control keypad

Two screws are used to attach the Motion Assist control keypad to the underside of the table (at the table's front edge), as shown in Figure 17.

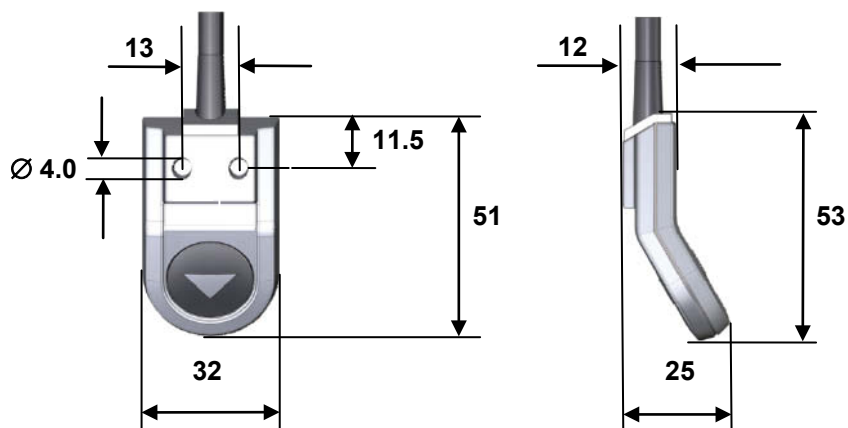

Figure 16 Motion Assist control keypad, installation dimensions (in mm)

5.3.2 Installing the control keypad to the tabletop

- Example: Use screws (B in Figure 17) which meet the requirements of DIN 7981 with \varnothing 3.9 mm and of suitable length (10 mm plus the screw-in depth into the table), screw head: \varnothing 7.5 mm.

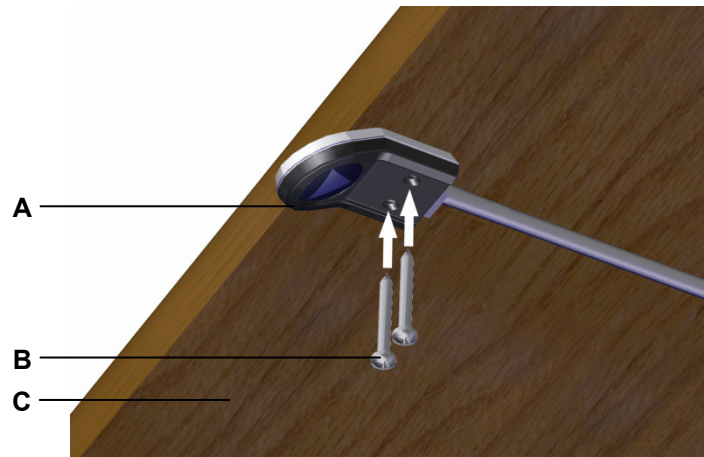

Figure 17 Example: Mounting the Motion Assist control keypad

A Motion Assist control keypad

B Screws

C Tabletop

5.3.3 HSCO control keypad

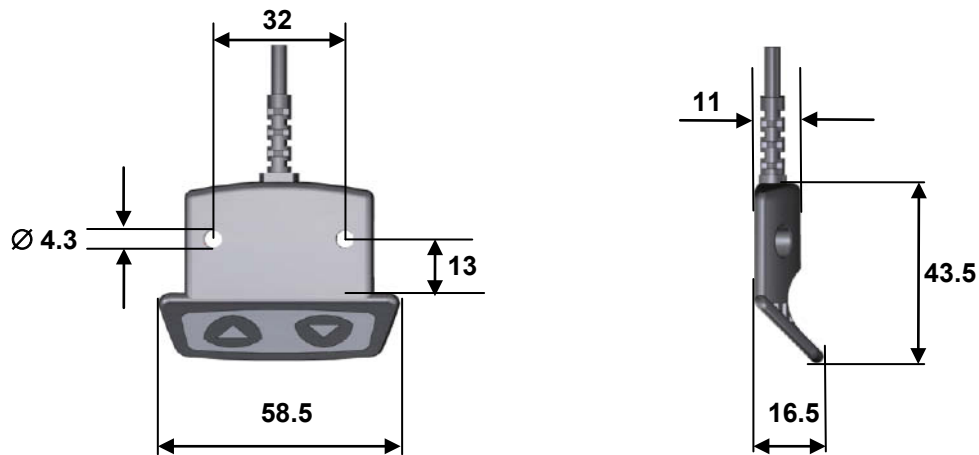

Figure 18 HSCO control keypad, installation dimensions (in mm)

5.3.4 HSU Varioline control keypad

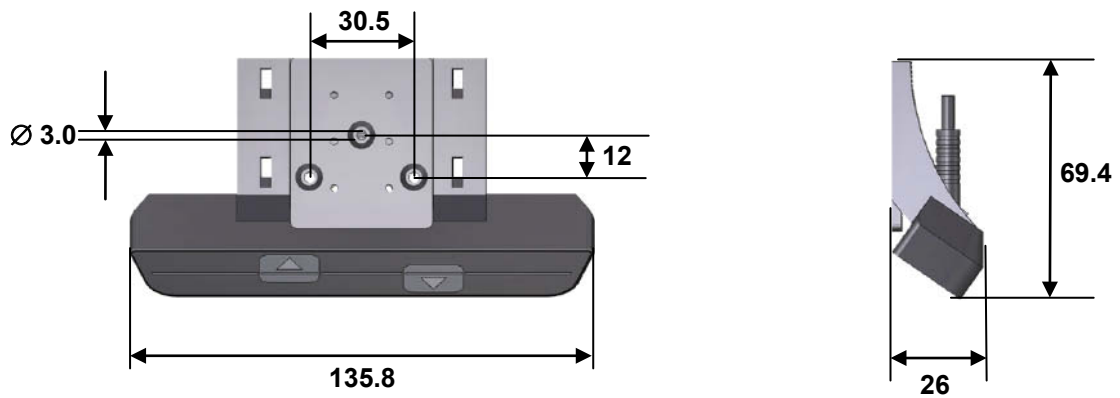

Figure 19 HSU Varioline control keypad, installation dimensions (in mm)

5.3.5 HSU control keypad

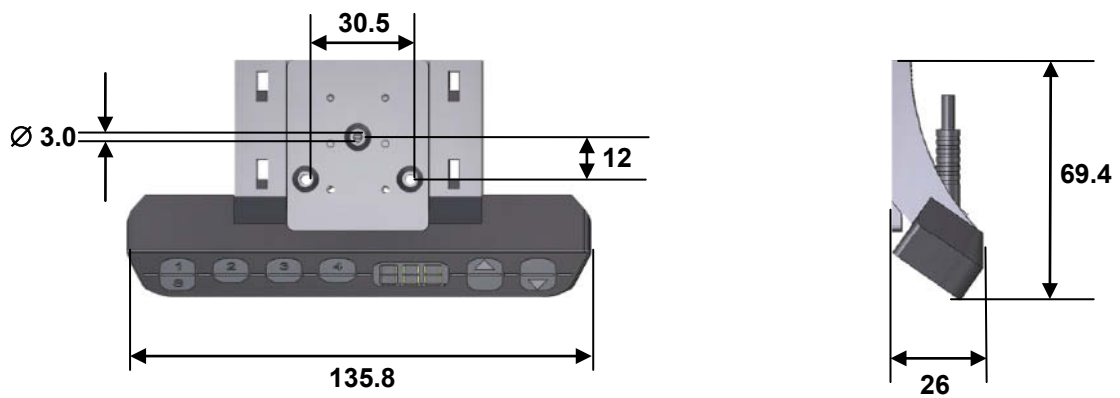

Figure 20 HSU control keypad, installation dimensions (in mm)

5.3.6 HSF control keypad

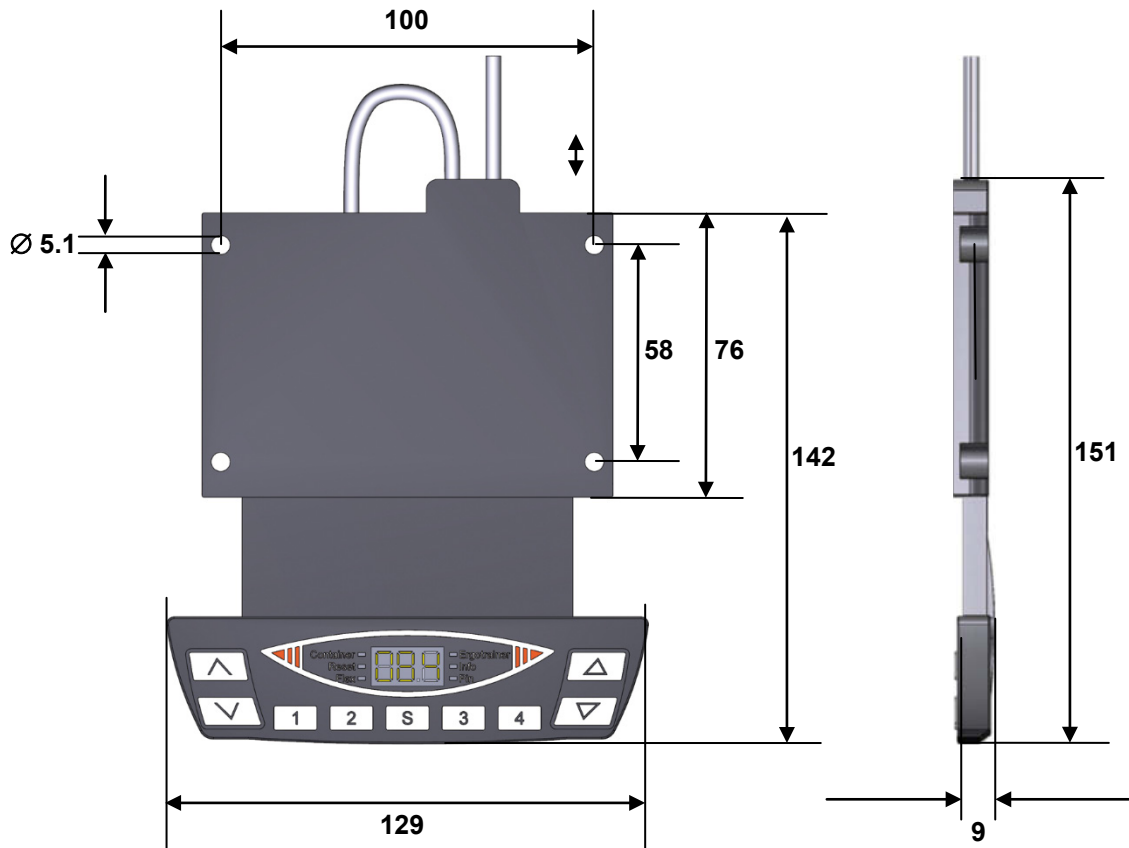

Figure 21 HSF control keypad, installation dimensions (in mm)

5.3.7 Touch basic IL control keypad

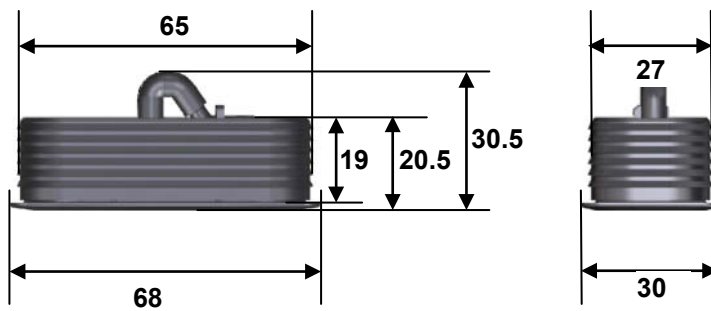

Figure 22 Touch basic IL control keypad, installation dimensions (in mm)

5.3.8 Touch basic DN control keypad

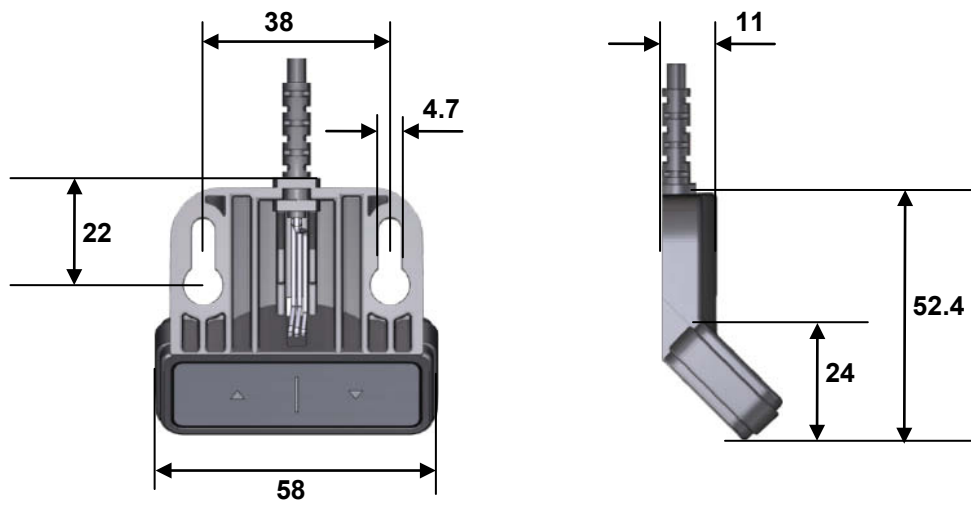

Figure 23 Touch basic DN control keypad, installation dimensions (in mm)

5.4 Installing the SMART/COMPACT control units

NOTICE

Please observe the thickness of the tabletop.

- ▶ Mount the control unit under the centre of the table. The best installation position is between the table frames. Be sure to note the length of the connecting cables during the installation.
- ▶ Use 4.8xL raised-head screws (according to requirements of DIN 7981) with a 9.5 mm head diameter and of suitable length (2 mm + screw-in depth into the table). Tighten the screw using a **maximum** torque of 2 Nm.

**CAUTION**

You should only install and uninstall the control unit when it is completely disconnected from any live current!

Mount the control unit as shown in Figure 25 (for the SMART) or Figure 27 (for the COMPACT):

- 1 Mark the drill holes. The positions of the holes are shown in Figure 24 (SMART) or Figure 26 (COMPACT).
- 2 Use a suitable drill to drill the two holes.
- 3 Screw the control unit onto the tabletop.
- 4 Route all connecting cables under the tabletop so that they cannot be pinched during the table's lifting movements.

5.4.1 SMART control unit

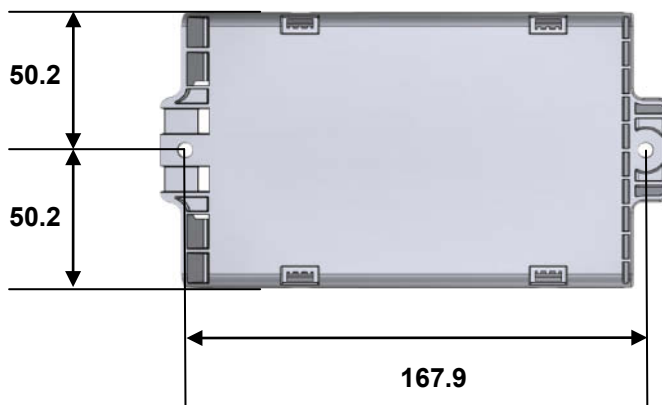

Figure 24 Mounting dimensions: SMART control unit (in mm)

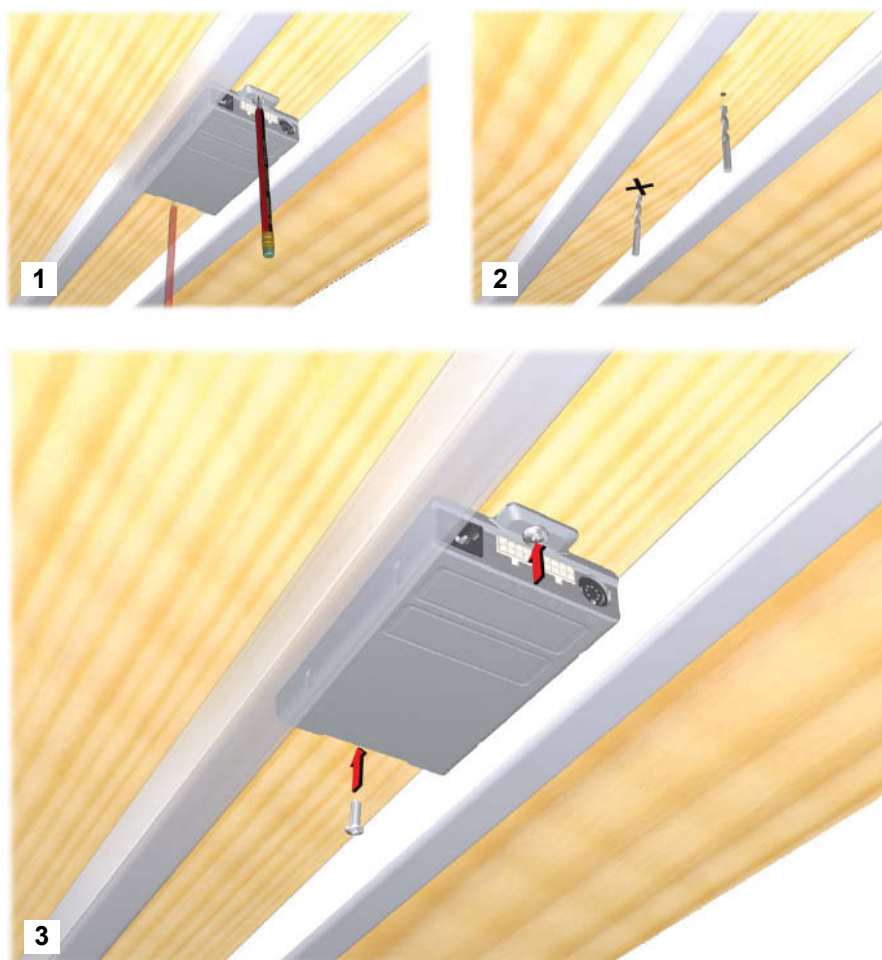

Figure 25 Mounting the SMART control unit

5.4.2 COMPACT control unit

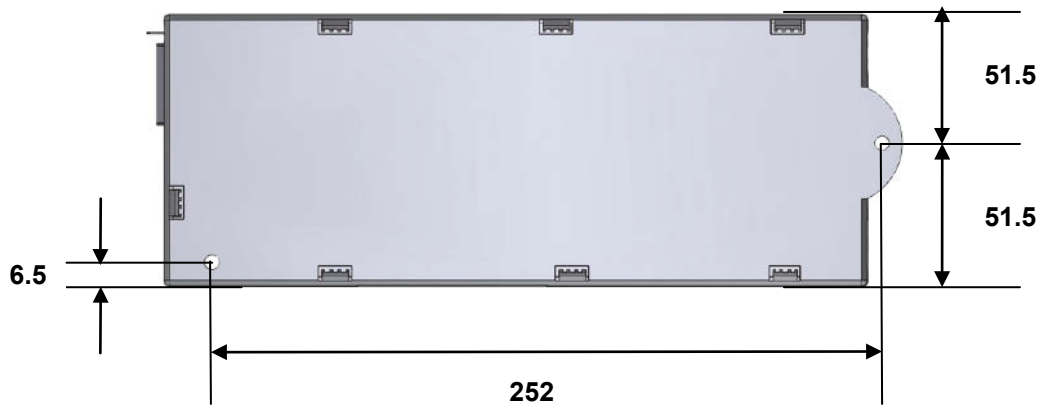

Figure 26 Mounting dimensions: COMPACT control unit (in mm)

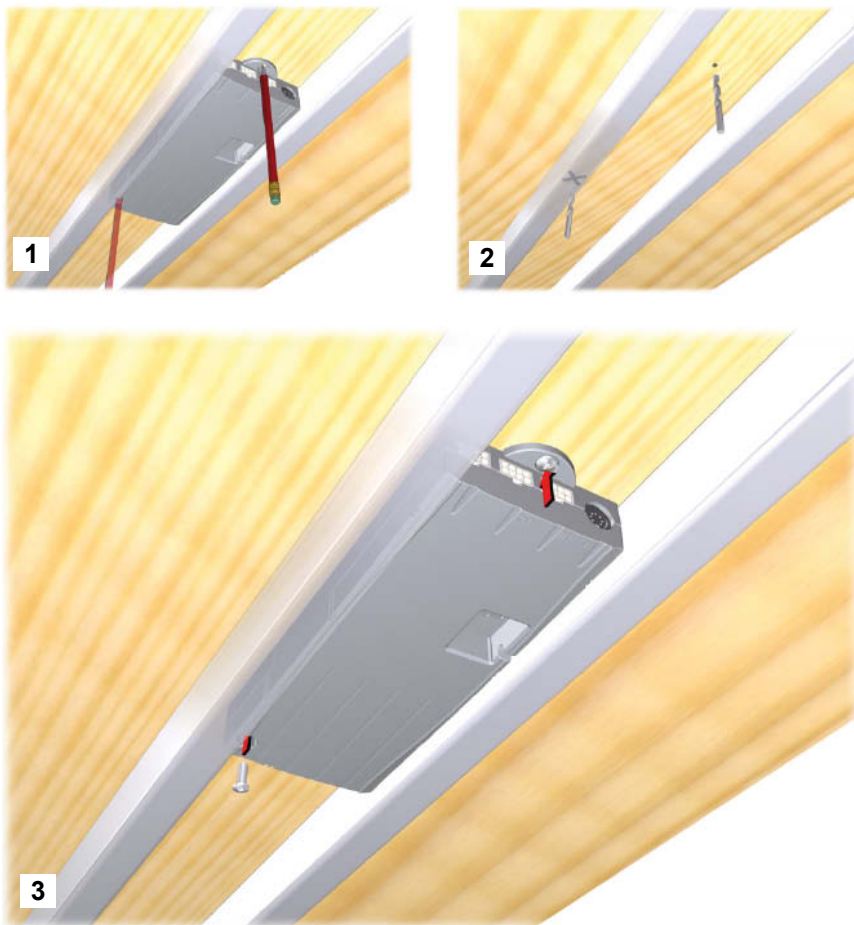

Figure 27 Mounting the COMPACT control unit

5.5 Electrical connections for the SMART/COMPACT control units

CAUTION

Electrical components should be connected or disconnected only when the power supply cord is unplugged.

NOTICE

There is a delay after the supply voltage is applied before the device actually turns on. Wait at least seven seconds before beginning the commissioning.

5.5.1 Connecting the lifting columns and the control keypad to the SMART control unit

The lifting columns and the control keypad are both connected to the front of the SMART control unit (the unit for adjusting one or two lifting columns). The following illustration shows the location of these connections.

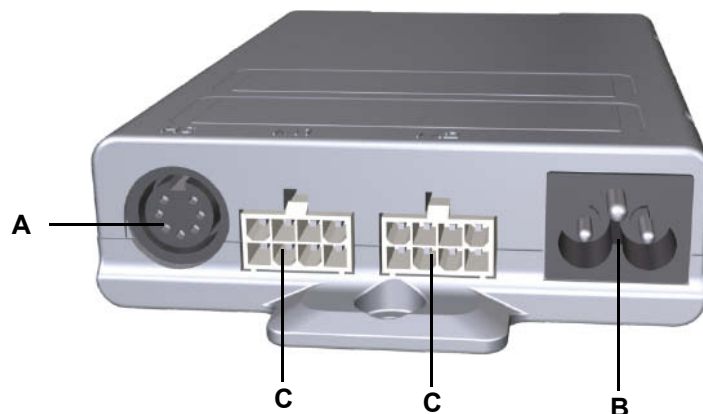

Figure 28 Connection ports on the SMART control unit: Model used for two lifting columns

A Connection for the control keypad

B Mains power supply connection

C Connection for the lifting columns

NOTICE

Be sure to connect the power cable into the control unit after all other connections are plugged in.

5.5.2 Connecting the lifting columns and the control keypad to the COMPACT control unit

The lifting columns and the control keypad are both connected to the front of the COMPACT control unit. A sensor or a second control unit can optionally be connected with a cable to the top of the control unit.

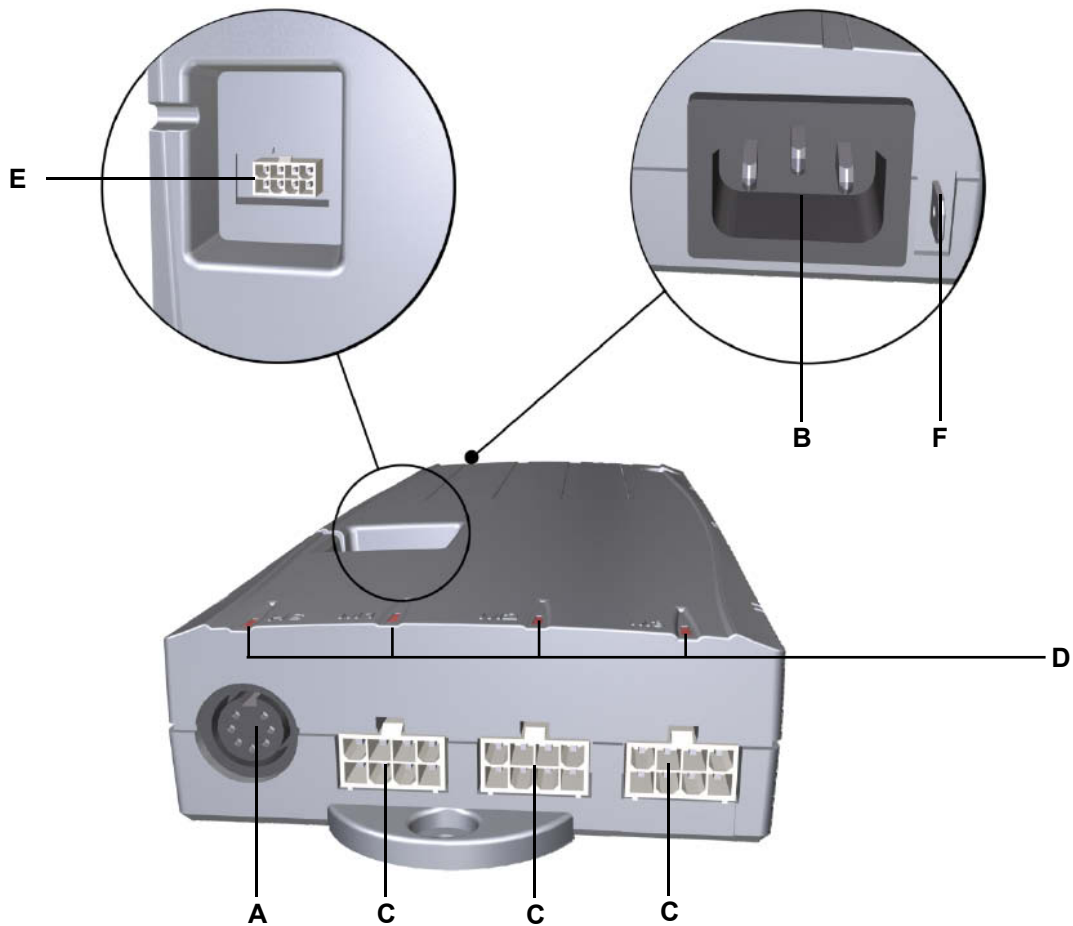

Figure 29 Connection ports on the COMPACT control unit

- | | |
|---|--|
| A Connection for the control keypad | B Mains power supply connection |
| C Connection for the lifting columns | D Status LEDs |
| E Sensor connection / cascade connection | F Protective earth connection |

NOTICE

Be sure to connect the power cable into the control unit after all other connections are plugged in.

5.6 Mounting the sensor unit

The COMPACT control unit can be equipped with a protective mechanism. A sensor unit (sensor and processor) can be mounted under the tabletop between the table frames.

- ▶ The sensor is attached to both the table frame and the tabletop. The contact point with the tabletop is marked with a yellow dot, as shown in Figure 30.

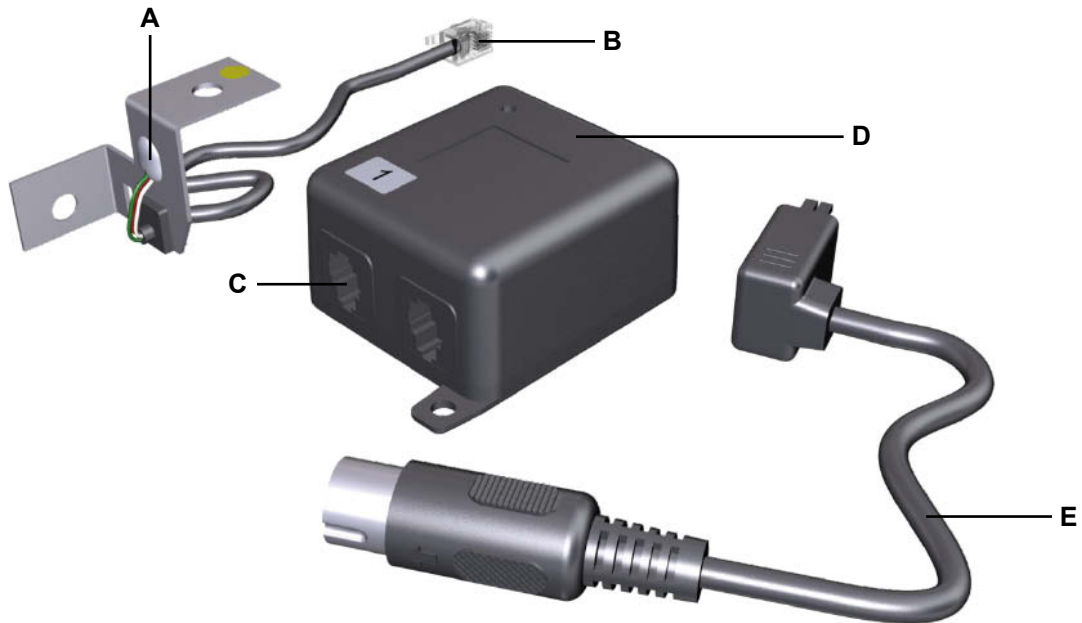

Figure 30 Sensor unit

- | | |
|--|---|
| A Sensor | B Connecting cable (for connection to processor) |
| C Connection for the sensor cable | D Processor |
| E Connecting cable for control unit | |

NOTICE

This protective mechanism only works when the sensor is correctly installed. Make sure that the side of the sensor marked with a yellow dot is facing the tabletop.

⚠ CAUTION

- You should only install and remove the sensor when it is completely disconnected from any live current!
- This safety mechanism is not effective unless the drilled holes are aligned exactly with each other. Personal injury and property damage can result from improper alignment.

- ▶ The screws are not included in our delivery.

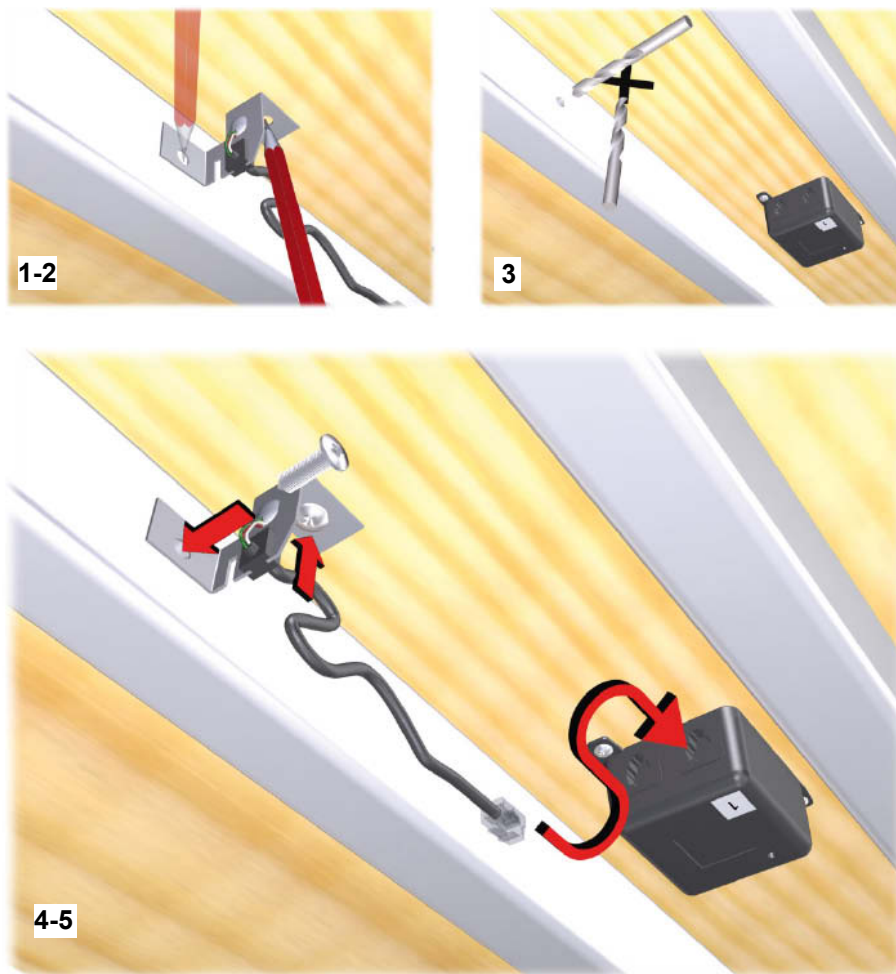

Figure 31 Mounting the sensor unit (sensor and processor)

Mount the sensor bracket marked with the yellow dot to the underside of the tabletop. Mount the second bracket to the table frame (as shown in Figure 31).

- ▶ Before mounting the sensor, make sure that the cables are long enough to reach the sensor in that position. Also make sure that the cables are routed so that they cannot be pinched during the up and down movements.
- 1 Mark the drill holes used for mounting the processor. Drill pilot holes and then screw the processor on the underside of the tabletop so that it is in the vicinity of the control unit.
 - 2 If no holes are pre-drilled, mark the drill holes for mounting the sensor (on underside of tabletop and on table frame).
 - 3 Drill the holes for mounting the sensor.

 **CAUTION**

Observe the following information in order to ensure that the safety mechanism functions properly:

- If the screws are not tightened properly, the safety mechanism will not function effectively.
- Use both screws.
- Take appropriate measures to prevent the screws from loosening during operations: loose screws will prevent the safety mechanism from functioning effectively.
- The connected cables may be neither too slack nor too tight.

4 Screw on the sensor. Pay attention to the correct positioning (the side with the yellow dot should be mounted to the underside of the tabletop). Observe the recommended torques:

- Mount to table frame: 3 Nm,
- Mount to tabletop: 2 – 2.5 Nm (depending on the type of wood in use).

 **CAUTION**

In order to ensure the effectiveness of the safety mechanism, note the following when connecting the processor:

- If only one sensor is being connected, it should be connected to the socket number 1.
- If a second sensor is being connected to the processor, connect it to the other available socket.
- Only one sensor may be connected to the processor when you are cascading several control units! This one sensor should then be connected to the socket number 1.

5 Connect the sensor's cable to the processor.

6 Connect the processor's cable to the COMPACT controller (see Figure 29).

5.6.1 Mains power supply for the SMART/COMPACT control units

⚠ CAUTION

Please follow these operating instructions carefully. You could be injured by fire or electrical shock if you do not follow these assembly instructions.

The appropriate power cord is included, depending on the regional version (USA, continental Europe, the UK, Japan or Australia).

⚠ CAUTION

Only use the proper power cable that is permitted in your country. Be sure to use the correctly shaped plug, as shown in the following illustration.

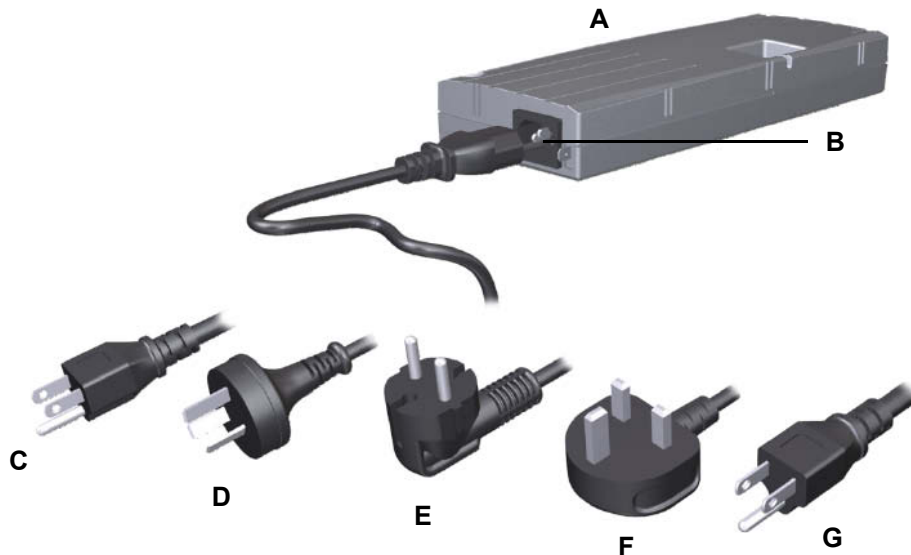

Figure 32 Power cord, regional variants

- | | |
|---|--|
| A COMPACT control unit (example) | B Mains power supply connection |
| C Power plug (USA) | D Power plug (Australia) |
| E Power plug (EURO flat plug) | F Power plug (United Kingdom) |
| G Power plug (Japan) | |

After plugging the power plug into the power outlet:

NOTICE

There is a delay after the supply voltage is applied before the device actually turns on. Wait at least seven seconds before beginning the commissioning.

- ▶ You will need to carry out a reset movement on the control unit (see section 6.1 on page 40) after the initial commissioning.

6. Initial commissioning

CAUTION

The ID21 system must first be fully installed (see chapters 4 and 5) and all components must be connected before you can carry out the initial commissioning.



It is not possible to connect a second control unit or additional lifting columns later.

6.1 Reset during commissioning

CAUTION

Danger of crushing injury!

No system-based safety mechanism is active during the reset process.

- 1 Connect the power cable to the control unit's power connection.
- 2 Insert the mains power plug into a power outlet.
- 3 Press and hold the  key (adjusting downward) until the tabletop moves all the way down.
- 4 Press the  key for at least five seconds longer.
- 5 The lifting column moves briefly downwards, then immediately upwards and then comes to a stop.
- 6 The reset is now finished. You can now press the corresponding key to raise or lower the lifting columns.

7. Notes for operation

These installation instructions do not contain all information required for the safe operation of the end product. They only describe the installation and operation of the drive as components (as defined in the Machinery Directive as a "partially assembled piece of machinery").

7.1 General information

CAUTION

Danger of crushing injury!

Make sure that there are no persons (especially children) or objects located in the range of movement while the table is moving.

Delayed start-up

After plugging the power plug into the power outlet:

NOTICE

There is a delay after the supply voltage is applied before the device actually turns on. Wait at least seven seconds before beginning the commissioning.

Power-on time / intermittent operations

NOTICE

The SMART/COMPACT control units have been designed for intermittent operations. Intermittent operation is an operational mode where the drive must pause after a specified maximum period of operation (power-on time). This protects the drive from overheating. Extreme overheating can cause a malfunction.

- ▶ The ratings plate specifies the maximum power-on time and the required pause intervals.

Avoiding electrical risks

CAUTION

Make sure that all live (current-carrying) parts of the drive system and power supply cannot be touched. In particular, be sure that unused power and control unit connections are covered adequately.

Reducing the risk of overheating with the thermal monitor

**CAUTION**

The SMART/COMPACT control unit is equipped with a thermal monitor (circuit breaker) that triggers when the unit overheats. If the temperature control has triggered, remove the control unit from the power supply, allow it to rest for 20 to 30 minutes and try again. If the control unit still does not function, please contact your supplier or sales agent.

Shutting down the ID21 system in an emergency

Pull out the power plug in order to shut off the ID21 system. The power plug must always be accessible during operations so that emergency shut-off is possible.

Avoiding cable damage

Be sure that your operating instructions inform the user about the possible cable risks.

NOTICE

The cables (in particular the electrical connection for the drives and the power supply cable for the drive system) must not be squashed or crushed. In order to prevent damage to the drive, no mechanical strain should be placed on the cables.

8. Operating the control keypads

8.1 Functions of the Motion Assist control keypad





Figure 33 Motion Assist control keypad

A Key for adjusting downwards

D Key for adjusting upwards: located on the underside of the control keypad

8.1.1 Key assignments for the Motion Assist control keypad

Key	Function
	Adjusting downwards
	Adjusting upwards
	For carrying out the reset motion after a malfunction (refer to 6.1).

- ▶ Press the key on the control keypad to raise or lower the table. Keep pressing the key until the desired height of the table is reached.

8.2 Functions of the HSCO control keypad

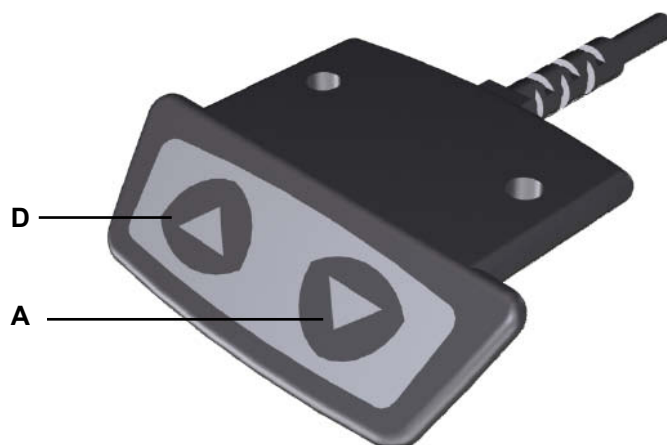





Figure 34 HSCO control keypad

A Key for adjusting downwards

D Key for adjusting upwards

8.2.1 Key assignments for the HSCO control keypad

Key	Function
	Adjusting downwards
	Adjusting upwards
	For carrying out the reset motion after a malfunction (refer to 6.1).

- ▶ Press the key on the control keypad to raise or lower the table. Keep pressing the key until the desired height of the table is reached.

8.3 Functions of the HSU Varioline control keypad

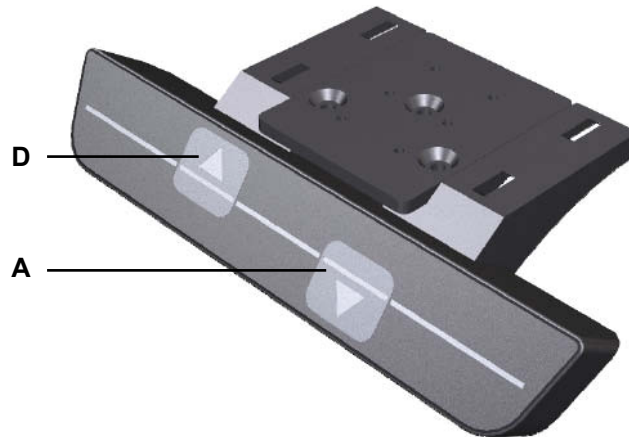





Figure 35 HSU Varioline control keypad

A Key for adjusting downwards

D Key for adjusting upwards

8.3.1 Key assignments for the HSU Varioline control keypad

Key	Function
	Adjusting upwards
	Adjusting downwards
	For carrying out the reset motion after a malfunction (refer to 6.1).

- ▶ Press the key on the control keypad to raise or lower the table. Keep pressing the key until the desired height of the table is reached.

8.4 Functions of the HSU control keypad

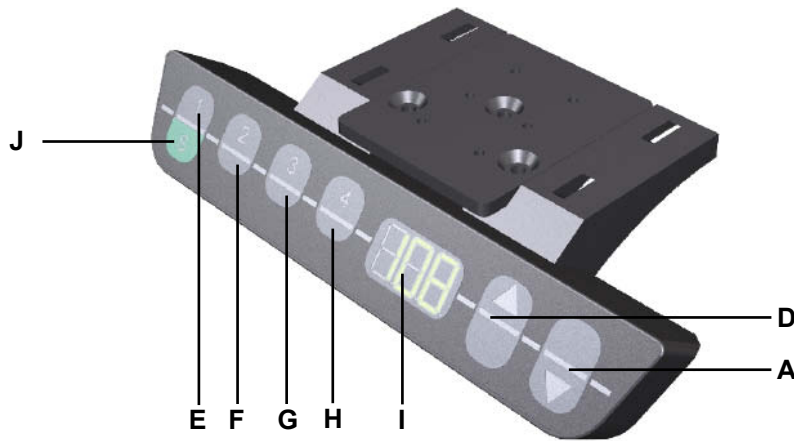

Figure 36 HSU control keypad

- A** Key for adjusting downwards
- E** Memory key 1
- G** Memory key 3
- I** Display
- D** Key for adjusting downwards
- F** Memory key 2
- H** Memory key 4
- J** Save key S

8.4.1 Key assignments for the HSU control keypad

Key / indicator	Function	Key / indicator	Function
	Display		Memory key 3
	Memory key 1		Memory key 4
	Save key S		Adjusting upwards
	Memory key 2		Adjusting downwards
			For carrying out the reset motion after a malfunction (refer to 6.1).

- ▶ The display on the HSU control keypad consists of a 3-character positional and information display.
- ▶ Using the keys for upwards or downwards adjustments: Press and hold the corresponding key until the desired position is reached.





8.4.2 Advanced functions

Saving a position

Any table position can be saved using this function.



- ▶ When the controller is turned on for the first time, all positions are equal to the minimum table position (the lower end position).
- ▶ Only one table position can be stored per memory key.

To save a position, proceed as follows:

- 1 Move the table to the position that you want to save.
The position is shown on the display (e.g. 73 cm).

- 2 Press the green Save key.

S - is now shown on the display.

- 3 Press the desired memory key (e.g. 2).

S 2 is shown on the display.

- 4 The set table position is now saved for the selected memory key.
A double-click noise can then be heard. After about two seconds, the saved table position is displayed.

Adjusting the table to a saved height position

This function allows you to set the table to a saved table position.

- 1 Press and hold the memory key that corresponds to the desired table position (e.g. position 2).

The table will move as long as the memory key is pressed. If you release this key before the saved position is reached, the table will stop before it reaches this position.
- 2 Release the key when the table has reached the saved position.

The current (saved) position is shown on the display.

8.5 Functions of the HSF control keypad

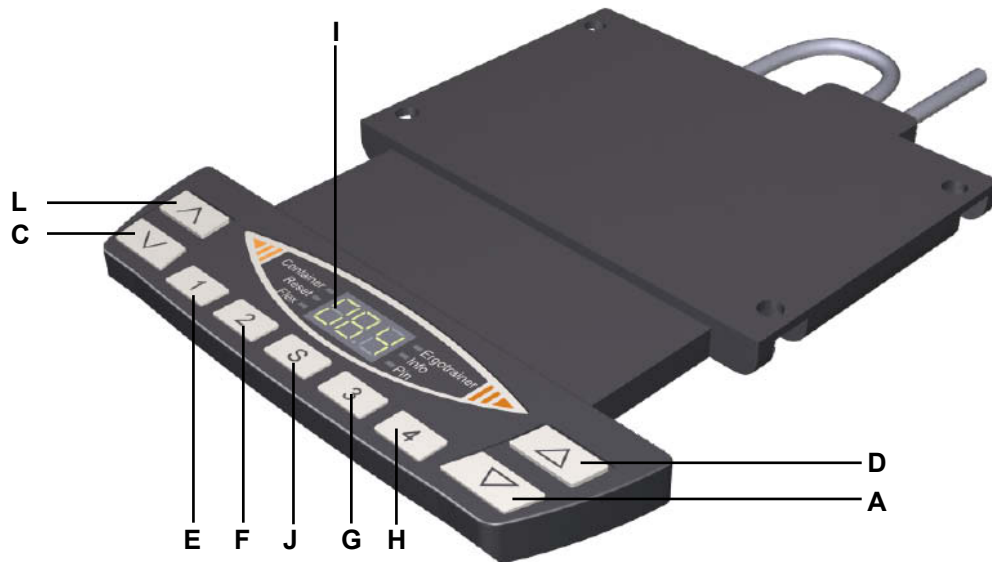













Figure 37 HSF control keypad

- A** Key for adjusting downwards
- E** Memory key 1
- G** Memory key 3
- I** Display
- K** Motor group 2, adjust downwards
- D** Key for adjusting upwards
- F** Memory key 2
- H** Memory key 4
- J** Save key S
- L** Motor group 2, adjust upwards

8.5.1 Key assignments for the HSF control keypad

Key / indicator	Function	Key / indicator	Function
	Display and LED indicators (refer to section 8.5.2)		Memory key
	Motor group 2, adjust upwards		Memory key 3
	Motor group 2, adjust downwards		Memory key 4
	Memory key 1		Adjusting upwards
	Memory key 2		Adjusting downwards
			For carrying out the reset motion after a malfunction (refer to 6.1).

- Using the keys for upwards or downwards adjustments: Press and hold the corresponding key until the desired position is reached.

8.5.2 Display functions

The display on the HSF control keypad is a 3-character positional and information display. There are also 6 information LEDs arranged side-by-side.

LED	Function
Container LED	This LED indicates that the container stop is enabled. (Depending on controller model in use.)
Reset LED	This LED indicates that a controller reset is being carried out. (Depending on controller model in use.)
Flex LED	This LED indicates that the Flex function is enabled. (Depending on controller model in use.)
Ergo-trainer LED	This LED indicates that the ergo-trainer is enabled. (Depending on controller model in use.)
Info LED	This LED indicates that important information is displayed on the positional/information display. (Depending on controller model in use.)
PIN LED	This LED indicates that the PIN CODE function is enabled.





8.5.3 Advanced functions

Saving a position

Any table position can be saved using this function.

- ▶ When the controller is turned on for the first time, all positions are equal to the minimum table position (the lower end position).
- ▶ Only one table position can be stored per memory key.

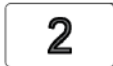
To save a position, proceed as follows:

- 1 Move the table to the position that you want to save.
 The position is shown on the display (e.g. 73 cm).
- 2 Press the Save key.
 **S** - is now shown on the display.
- 3 Press the desired memory key (e.g. 2).
 **2**
 **S 2** is shown on the display.
- 4 The set table position is now saved for the selected memory key. A double-click noise can then be heard. After about two seconds, the saved table position is displayed.

Adjusting the table to a saved height position

This function allows you to set the table to a saved table position.

2

- 1 Press and hold the memory key that corresponds to the desired table position (e.g. position 2).

The table will move as long as the memory key is pressed. If you release this key before the saved position is reached, the table will stop before it reaches this position.





- 2 Release the key when the table has reached the saved position.

073

The current (saved) position is shown on the display.

Adjusting the motor group 2 to a saved position

This function allows you to set the table (motor group 2) to a saved table position.

- If there is no second motor group, then the  and  keys are assigned the same functions as the  and  keys.

Move table upwards (motor group 2):



- 1 Press the  key for moving up. Press the key down until the table has reached the saved position.

The table will move up as long as the memory key is pressed. If you release this key before the saved position is reached, the table will stop before it reaches this position.

Move table downwards (motor group 2):



- 2 Press the  key for moving down. Press the key down until the table has reached the saved position.

The table will move down as long as the memory key is pressed. If you release this key before the saved position is reached, the table will stop before it reaches this position. Release the key when the table has reached the saved position.

8.6 Functions of the Touch basic IL control keypad





Figure 38 Touch basic IL control keypad

A Key for adjusting downwards

D Key for adjusting upwards

8.6.1 Key assignments for the Touch basic IL control keypad

Key	Function
	Adjusting downwards
	Adjusting upwards
	For carrying out the reset motion after a malfunction (refer to 6.1).

- Press the key on the control keypad to raise or lower the table. Keep pressing the key until the desired height of the table is reached.

8.7 Functions of the Touch basic DN control keypad





Figure 39 Touch basic DN control keypad

A Key for adjusting downwards

D Key for adjusting upwards

8.7.1 Key assignments for the Touch basic DN control keypad

Key	Function
	Adjusting downwards
	Adjusting upwards
	For carrying out the reset motion after a malfunction (refer to 6.1).

- ▶ Press the key on the control keypad to raise or lower the table. Keep pressing the key until the desired height of the table is reached.

9. Troubleshooting

This chapter describes troubleshooting methods for fixing problems. If you experience an error that is not listed in this table, please contact your supplier or sales agent.



CAUTION

Only qualified specialists who have received electrician training should carry out troubleshooting and repairs.

9.1 Malfunctions

Problem	Possible cause	Solution
The drives are not functioning.	There is no mains supply voltage.	Connect the mains power supply.
	The drives are not connected.	Connect the motor's connecting cable to the control unit.
	A plug has a bad contact.	Make sure that the motor cable, the power supply and the control keypad are properly and firmly connected.
	A control unit or a control keypad is defective.	Please contact your supplier or sales agent.
The drives are running in only one direction.	There was a power outage during an adjustment movement or the power cable was disconnected during a movement.	Carry out the reset movement.
	The control unit, drive, or control keypad is defective.	Please contact your supplier or sales agent.
The control unit or control keypad is not functioning properly.	There is no mains supply voltage.	Connect the mains power supply.
	The control keypad is not connected.	Connect the control keypad.
	The control unit, power cable or control keypad is defective.	Please contact your supplier or sales agent.
	A plug has a bad contact.	Make sure that the plugs are firmly seated and properly connected.

9.2 Error messages on the control keypad's display

Displayed error message	Possible cause	Solution
	The SMART/COMPACT control unit is equipped with a thermal protective mechanism which has been triggered.	Wait until the control unit has cooled down and the message HOT is no longer displayed. The control unit is once again ready for operations.
	There is an internal error in the SMART/COMPACT control unit.	Proceed according to the instructions in the error list below.
00	Internal error channel 1	Switch off the control unit.
01	Internal error channel 2	Please contact your supplier or sales agent.
02	Internal error channel 3	
12	Malfunction channel 1 (SMART/COMPACT)	Disconnect all connecting cables from the control unit.
13	Malfunction channel 2 (SMART/COMPACT)	Find and correct the short circuit. Reconnect the control unit and resume operations.
14	Defect on channel 3 (COMPACT only)	Connect the correct lifting column to the correct socket. Reconnect the control unit and resume operations.
24	Excessive current at lifting column M1 (SMART/COMPACT)	Remove the jammed objects from the range of movement.
25	Excessive current at lifting column M2 (SMART/COMPACT)	Table is overloaded: remove the excess load.
26	Excessive current at lifting column M3 (COMPACT)	Please contact your supplier or sales agent.
48	Excessive current at drive group 1 (SMART/COMPACT)	
49	Excessive current at drive group 2 (COMPACT)	
60	Collision protection	
62	Excessive current at control unit	
36	Plug detection at socket M1	Connect the correct lifting column to the correct socket.
37	Plug detection at socket M2	Carry out the reset movement.
38	Plug detection at socket M3	
61	Lifting columns are wrong.	

Displayed error message	Possible cause	Solution
55	Synchronization of drive group 1	Remove the load from the table.
56	Synchronization of drive group 2	Carry out the reset movement. The error is still displayed after the reset: Please contact your supplier or sales agent.
67	The voltage is too high.	Disconnect the mains cable from the power supply. Please contact your supplier or sales agent.
70	Changed drive configuration	<p>First option:</p> <p>Disconnect the mains power cable from the power supply and wait at least five seconds.</p> <p>Connect the mains power cable to the power supply.</p> <p>Carry out the reset movement.</p> <hr/> <p>Second option:</p> <p>Simultaneously press the Memory position 1 and 2 keys and the Tabletop up key. Hold the keys down for about ten seconds and then release them.</p> <p>S 1 is now shown on the display.</p> <p>Press down on the Tabletop up key until S 7 appears in the display.</p> <p>Press the Memory key.</p> <hr/> <p>Third option:</p> <p>Please contact your supplier or sales agent.</p>

Displayed error message	Possible cause	Solution
71	Change the anti-pinch configuration	<p>Refer to error 70.</p> <hr/> <p>Disable the sensor unit: Remove a sensor unit from the COMPACT control unit. The error E71 appears on the display.</p> <p>Verify that the sensor unit is no longer connected to the COMPACT control unit.</p> <p>Press down on the Tabletop up key until the tabletop has reached its upper position. The COMPACT control unit clicks three times: the sensor unit is now deactivated.</p>
81	Internal error	<p>Carry out the reset movement.</p> <hr/> <p>Disconnect the mains cable from the power supply. Reconnect the power supply cable after a few seconds.</p> <hr/> <p>If this error is displayed multiple times: Disconnect the mains cable from the power supply. Please contact your supplier or sales agent.</p>

- ▶ A manual reset may be required if there was a power outage (or if the power cord was disconnected) during the height adjustment process.

9.3 Error messages, as indicated by clicking tones from the control unit

Number of clicks	Explanation	Solution
Two	Normal operations (The system is working properly.)	-
One	Emergency mode (The lifting columns cannot be used in emergency mode.)	Check the LEDs and the error code on the display of the control keypad.
3 – 6	The last shutdown was incomplete. Forced reset movement	Check the LEDs and the error code on the display of the control keypad.

9.4 Error messages displayed by the LEDs (COMPACT control unit)

LED display	Explanation	Solution
Control unit LED is flashing.	Internal error	Carry out the reset movement. Disconnect the mains cable from the power supply. Reconnect the power supply cable after a few seconds. Disconnect the mains cable from the power supply. Please contact your supplier or sales agent.
Control unit LED is illuminated.	A reset movement is required.	Carry out the reset movement. Note: This LED is also illuminated during the reset movement or after the reset was not executed to completion. It goes off when the reset is finished.
The LED over the lifting column port is flashing.	There is a short circuit on the lifting column.	Disconnect the control unit's connecting cable. Find and correct the short circuit. Reconnect the control unit and resume operations.
The LED over the lifting column port is illuminated.	A lifting column is missing.	Connect the correct lifting column to the correct socket. Carry out the reset movement.

10. Maintenance and cleaning

- ▶ You should only use spare parts which have been manufactured or approved by DewertOkin. Only these parts will guarantee a sufficient level of safety.

10.1 Maintenance

Periodic inspections should be carried out in accordance with the German Social Accident Insurance (DGUV) guidelines / provision 3. A qualified electrician should carry out this inspection.

The following should also be checked frequently:

Type of check	Explanation	Time interval
Look over the housing periodically for any signs of damage.	Check the housing for breaks or cracks. The IP-class protection will be impaired by any breakage or cracks.	At least every six months.
Look over the cables, wires and strain relief mechanisms.	Check the cables for pinching or shearing. Also check the strain relief and kink protection mechanisms, in particular after any mechanical load.	At least every six months.
Check the resistance of the protective earth and check for leakage current.	The leakage current and the protective earth resistance should be checked by a trained electrician.	At least every six months.
Check the function and safety of the electrical system.	A qualified electrician should carry out this inspection. (Refer to the "Electrical connection" section in the "Installation" Chapter.)	Periodic inspections can be carried out at intervals based on the risk assessment which you conduct for your end product.

10.2 Cleaning

- ▶ Clean the ID21 system components using a dry cloth as often as needed.

NOTICE

- Always disconnect the mains power plug from the ID21 system before you start to clean it.
- Use a dry cloth to clean the ID21 system.
- Be sure that you do not damage the connecting cables during the cleaning.

11. Technical specifications and product designation

11.1 Table

Dimensions	
Tabletop (permitted dimensions):	
Length	1200 to 2000 mm
Width	800 to 1000 mm
Height	19 to 30 mm
Table frame	
Length x width x height	Depending on your model
Table legs	
Length x width x height	Depending on your model
Ambient conditions for operation, storage and transport	
Temperatures for transport and storage	From -20 °C to +50 °C From -4 °F to +122 °F
Operating temperature	From +10 °C to +40 °C From +50 °F to +104 °F
Relative humidity	From 30% to 75%
Air pressure	From 800 hPa to 1060 hPa
Height	< 2000 m

11.2 SMART and COMPACT control units

Control unit:	SMART eco	COMPACT eco	COMPACT eco+
Rated voltage	USA: 120V AC, 60Hz EU: 230V AC, 50Hz		
Standby power at rated voltage	≤ 0.3 W	≤ 0.3 W	≤ 0.1 W
Current consumption at rated load	Max. 8 A per channel and socket	Max. 7 A per channel and socket	
Mode of operations ¹	Intermittent duty 2 min./18 min.		
Protection class	I		
Protection degree	IP20		
Dimensions and weight			
Length x width x height (in mm)	186 x 100 x 30	264 x 103 x 37	264 x 103 x 37
Weight	305 g	523 g	523 g
Ambient conditions for operation, storage and transport			
Temperatures for transport and storage	From -20 °C to +50 °C From -4 °F to +122 °F		
Operating temperature	From +10 °C to +40 °C From +50 °F to +104 °F		
Relative humidity	From 30% to 75%		
Air pressure	From 800 hPa to 1060 hPa		
Height	< 2000 m		

¹ Mode of operation: intermittent duty 2 min./18 min. This means that after the unit is operated with its rated load for up to two minutes it must then be paused for 18 minutes. The system can malfunction if this pause is not observed!

11.3 Size of SMART control unit

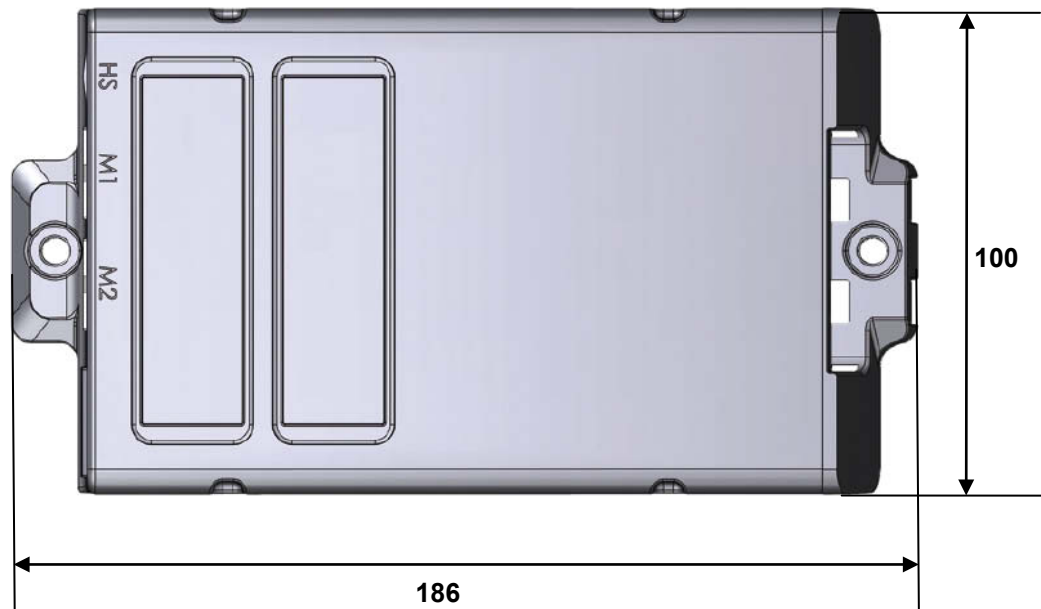

Figure 40 SMART control unit, top view (in mm)



Figure 41 SMART control unit, side view (in mm)

11.4 Size of COMPACT control unit

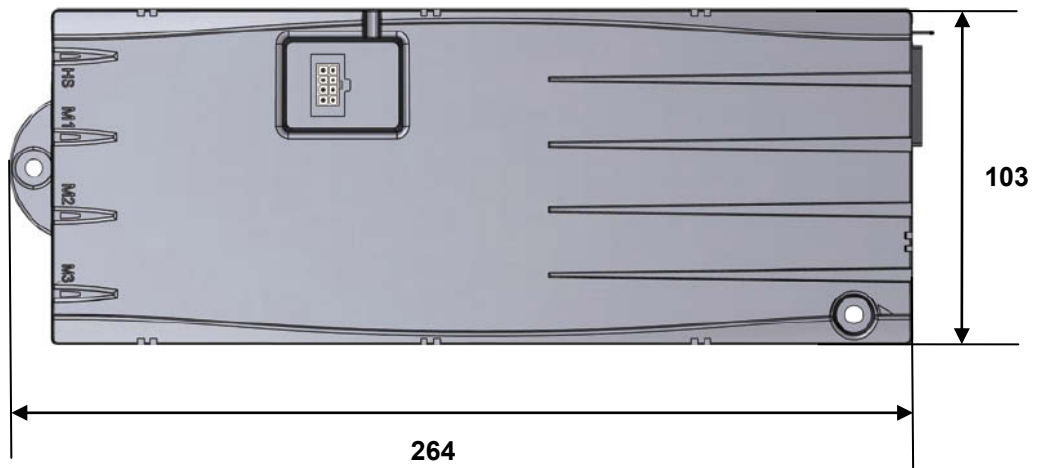

Figure 42 SMART control unit, top view (in mm)



Figure 43 COMPACT control unit, side view (in mm)

11.5 ID21 lifting column

Input voltage	24 V DC – 29 V DC
Current consumption at rated load	Max. 7.0 A DC
Permitted push force	Max. 800 N
Bending torque, dynamic	<150 Nm (in the y direction, see Figure 45)
Torque, static	< 200 Nm
Self-locking	800 N
Mode of operation ¹ under max. rated load.	Intermittent duty 2 min./18 min.
Protection class	III
Noise level	≤ 48 dB(A)
Drive type	lifting column
Protection degree	IP20
Colours	RAL 9005, RAL 9006, RAL 9016
Stroke	650 mm
Length ² x width x height	520 mm x 80 mm x 62 mm
Length ³ x width x height	1170 mm x 80 mm x 62 mm
Size of columns	Exterior: 80 mm x 62 mm
	Middle: 73 mm x 58 mm
	Interior: 66 mm x 48 mm
Weight	Approx. 7.8 kg
Cable length	1200 mm
Ambient conditions for operation, storage and transport	
Transport / storage temperature	From -20 °C to +50 °C
	From -4 °F to +122 °F
Operating temperature	From +10 °C to +40 °C
	From +50 °F to +104 °F
Relative humidity	From 30% to 75%
Air pressure	From 800 hPa to 1060 hPa
Height	< 2000 m

¹ Mode of operation: intermittent duty 2 min./18 min. This means that after the unit is operated with its rated load for up to two minutes it must then be paused for 18 minutes. The system can malfunction if this pause is not observed!

² Length when retracted.

³ Length when fully extended.

11.6 Size of the ID21 lifting column

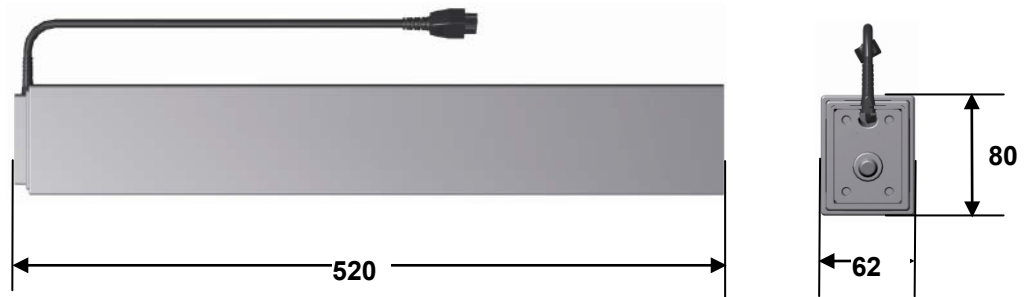

Figure 44 ID21 lifting column (in mm)

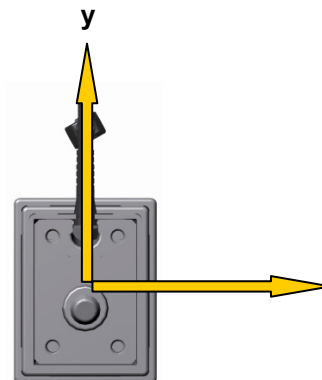

Figure 45 Top view (head end)

11.7 Product labelling

- ▶ The ratings plate shown is an example; the values shown in this example may differ from the specifications for your configuration.

11.7.1 Ratings plate on the control unit

A ratings plate (or type label) on each control unit specifies the exact name and serial number of the device. It also states the technical specifications valid for that particular control unit. The following illustration shows where the specifications are located on the ratings plate of the control unit.

Ratings plate on the COMPACT control unit

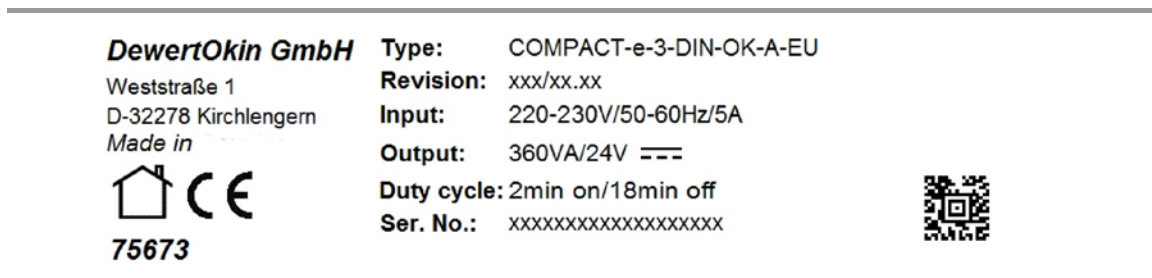



Figure 46 Ratings plate example

COMPACT-e-3-DIN-OK-A-EU	Model name
Revision: xxx/xx.xx	Software version
Input: 220-230V/50-60Hz/5A	Input voltage, frequency and current consumption
Output: 300VA/24 V ==	Power and output voltage
Duty cycle: 2 min on / 18 min off	Intermittent operations: 2 minutes / 18 minutes
Ser. No.	Serial number
	Use in dry rooms only!
	Conformity mark
75673	Article number

Ratings plate on the SMART control unit

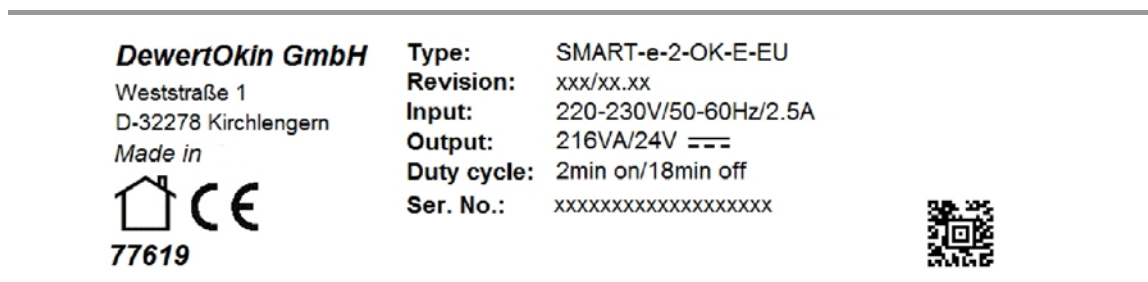



Figure 47 Ratings plate example

SMART-e-2-OK-E-EU	Model name
Revision: xxx/xx.xx	Software version
Input: 220-230V/50-60Hz/5A	Input voltage, frequency and current consumption
Output: 300VA/24 V \equiv	Power and output voltage
Duty cycle: 2 min on / 18 min off	Intermittent operations: 2 minutes / 18 minutes
Ser. No.	Serial number
	Use in dry rooms only!
	Conformity mark
77619	Article number

11.7.2 Ratings plate on the Motion Assist control keypad



Figure 48 Ratings plate example

M. Assist	Type designation for the Motion Assist
xxxxxxx	Article number
Prod.date 28/10	Calendar week / year

11.7.3 Ratings plate, control keypads

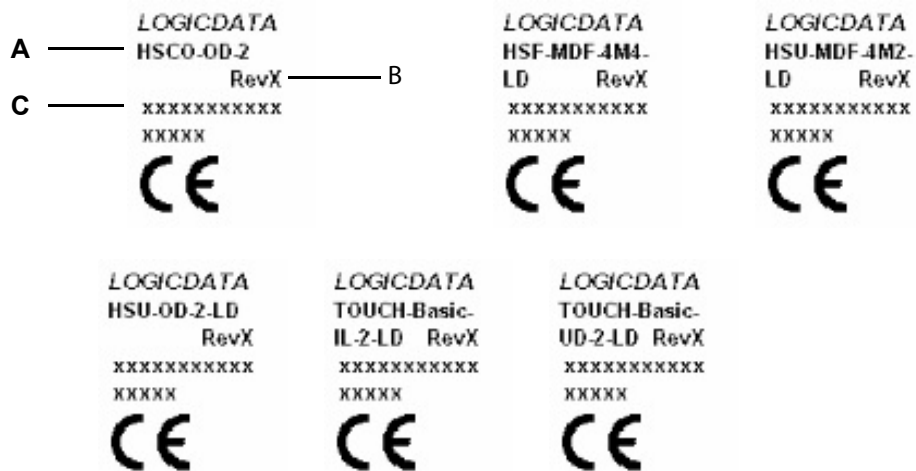



Figure 49 Rating plates (examples)



Position	Designation (example)	Explanation
A	HSF_MDF_4M4_LD	Type designation (abbreviation)
B	RevX	Revision
C	xxxxxxxxxxx	Serial number
		Conformity mark

11.7.4 Ratings plate on the ID21 lifting column

A ratings plate (type label) on each lifting column specifies the exact name and serial number of the lifting column. It also states the technical specifications valid for that particular lifting column. The following illustration shows where the specifications are located on the ratings plate.



Figure 50 Ratings plate example

ID21	Model name
xxxxx	Article number
24V – 29V ~	Input voltage
Max. 7.0A	Current consumption
Duty cycle: 2min ON /18min OFF	Intermittent operations: 2 minutes / 18 minutes
max. Push Force	Push force
Prod.date	Production date: Calendar week / year
Serial-No.	Serial number for your drive
IP20	Protection degree
	Use in dry rooms only!
	Conformity mark
	Follow the special assembly instructions!

11.7.5 Ratings plate on the table frame

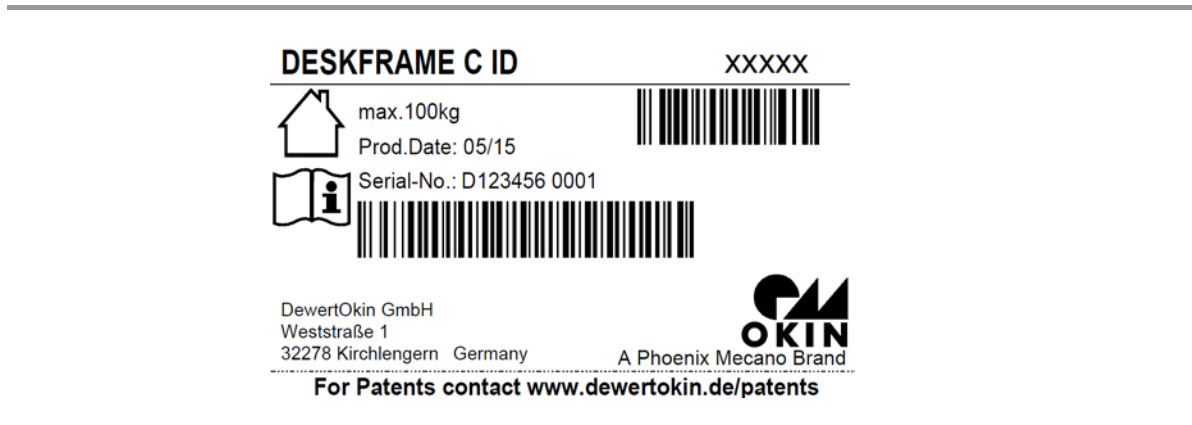



Figure 51 Ratings plate example

DESKFRAME C ID	Model name
xxxxx	Article number
Max. 100 kg	Maximum load on table
Prod.date	Production date: Calendar week / year
Serial-No.	Serial number
	Use in dry rooms only!
	Follow special assembly instructions!

12. Disposal

12.1 Packaging material

The packaging material should be sorted into recyclable components and then disposed of in accordance with the appropriate national environmental regulations (in Germany according to the recycling law KrWG from 01.06.2012; internationally according to the EU Directive 2008/98/EC (Waste Framework Directive WFD as of 12.12.2008)).

12.2 Drive components

The ID21 system consists of electronic components, cables and metal and plastic parts. You should observe all corresponding national and regional environmental regulations when disposing of the system.

The disposal of the end product is regulated in Germany by Elektro-G, internationally by the EU Directive 2011/65/EC (RoHS), or by any applicable national laws and regulations. (The end product is not regulated by the EU Directive 2012/19/EC (WEEE).)



The ID21 system components should not be disposed of with normal household waste!

Declaration of Incorporation/Installation

According to Appendix II of the EU Machinery Directive 2006/42/EC

The manufacturer:

DewertOkin GmbH

Weststraße 1

32278 Kirchlengern

Germany

declares that the incomplete machines described below

ID21 System

complies with the following basic requirements of the Machinery Directive (2006/42/EC):

Sections: 1.1.3; 1.3.3; 1.3.4; 1.3.7; 1.5.1; 1.5.2; 1.5.5; 1.5.6; 1.5.7; 1.5.8;
1.5.9; 1.5.10; 1.5.13; 1.6.3

Applied standards and technical report:

- EN ISO 12100:2010
- DIN-Fachbericht 147:2006-06
- EK 5/AK 3 „Möbel“
- DIN EN 527-1:2011
- DIN EN 527-2:2003
- DIN EN 527-3:2003

You may only operate this incomplete machine after you have confirmed that the end product (into which this machine will be installed) complies with the Machinery Directive 2006/42/EC.

On request, the manufacturer is obliged to send the special documentation accompanying the partially completed machinery in electronic form to the appropriate national institution. The special technical documents corresponding to the machine have been created according to Appendix VII, part B.

The following person is responsible for the technical documentation: Hans-Joachim Heimsath,
Address cited above.
Tel.: +49(0)5223 979-0



Dr.-Ing. Josef G. Groß
Managing Director

Kirchlengern, Germany. The 29.May 2015

EU Declaration of Conformity

In compliance with Appendix IV of the EU EMC Directive 2004/108/EC
In compliance with Appendix III of the EU Low Voltage Directive 2006/95/EC
In compliance with Appendix VI of the EU RoHS Directive 2011/65/EU

The manufacturer:
DewertOkin GmbH
Weststraße 1
32278 Kirchlengern
Germany

declares that the following product

ID21 System with DewertOkin drive system¹⁾

meets the requirements of the following EU directives:

Electromagnetic Compatibility Directive 2004/108/EC

Low Voltage Directive 2006/95/EC

RoHS Directive 2011/65/EU of the European Parliament and of the Council of 8 June 2011 on the restriction of the use of certain hazardous substances in electrical and electronic equipment

Applied standards:

- EN 55014-1/A2:2011
- EN 55014-2/A2:2008
- EN 61000-3-2/A2:2009
- EN 61000-3-3/A2:2008
- EN 60335-1:2012
- EN 62233:2008

This declaration of conformity is no longer valid if constructional changes are made which significantly change the product (i.e., which influence the technical specifications found in the instructions or the intended use)!



Kirchlengern, Germany. The 29.May 2015

Dr.-Ing. Josef G. Groß
Managing Director

¹⁾ DESKFRAME C ID-A with control unit: SMART-e (SMART eco), COMPACT-e (COMPACT eco) or COMPACT-e+ (COMPACT eco+)
with handset: HSCO (1.32.000.087.30), HSU (1.32.000.32.30 or 1.32.000.63.20), HSF (1.32.000.096.30), Motion Assist, Touch Basic IL or Touch Basic DN
with lifting column : ID21

DewertOkin GmbH
Weststraße 1
Kirchlengern 32278, Germany
Tel: +49(0)5223/979-0
Fax.: +49 0 522375182
<http://www.dewertokin.de>
Info@dewertokin.de

ID No.: 78438