



ECS Control Unit

Installation Instructions

(Translation of the original installation instructions)

Foreword

Document revision history

| Version | Date | Modification, change |
|---------|-------|---|
| (-) | 01/14 | First release |
| 1.0 | 09/19 | Ratings plate, Declaration of incorporation/installation EU Declaration of Conformity |

Disclaimer and exclusion of liability

DewertOkin is not responsible for damage resulting from:

- failure to observe these instructions,
- changes made to this product which have not been approved by DewertOkin, or
- the use of replacement parts which have not been approved or manufactured by DewertOkin.

Manufacturer's address

DewertOkin GmbH
 Weststraße 1
 32278 Kirchlengern, Germany
 Germany
 Tel: +49(0)5223/979-0
 Fax.: +49 0 522375182
<http://www.dewertokin.de>
Info@dewertokin.de

Creation of a complete operating instruction manual for the entire end product

These instructions are only intended to be used by the end-product manufacturer. They should not be given to the operator of the end product. The factual information contained within may be used as a basis when creating the end-product manual.

The warning and danger notices are best suited for use in the end product's manual. However it is not sufficient to simply follow these notices. You should also carry out an internal risk assessment for your end product. This can then be used as the basis for the safety notices in your manual.

Usage in medical products

The ECS control unit is not a medical product. If used in a medical end product, you (the end manufacturer) are obliged to ensure compliance with EC directives and to ensure that other pertinent medical product regulations are maintained.

Notice for customers in EU nations**German Inspection Authority (TÜV SÜD Product Service) testing label**

The construction of the ECS control unit has been inspected by the German TÜV SÜD Product Service Inspection Authority. TÜV SÜD Product Service also monitors the production of the ECS control unit. The official German TÜV SÜD Product Service certifies this construction inspection and production monitoring.

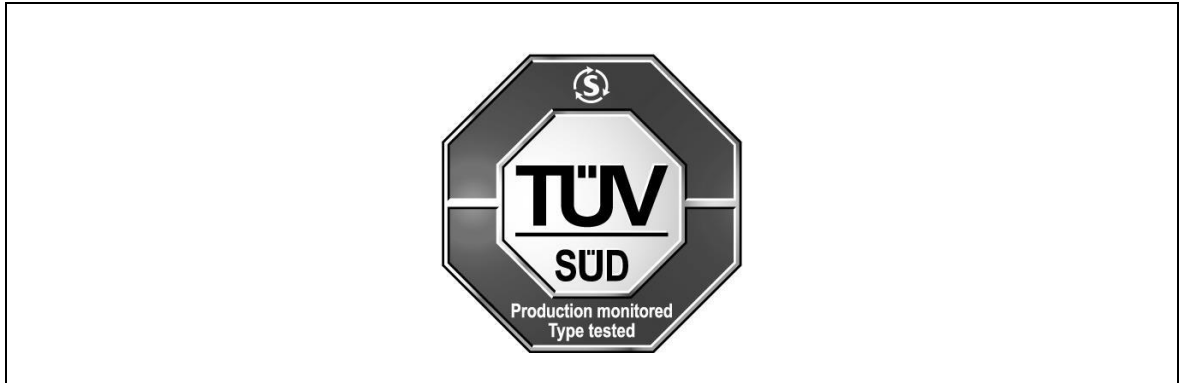

Figure 1 TÜV SÜD Product Service Safety Mark

Table of contents

| | |
|--|-----------|
| Foreword | 3 |
| Document revision history | 3 |
| Disclaimer and exclusion of liability | 3 |
| Manufacturer's address | 3 |
| Creation of a complete operating instruction manual for the entire end product | 3 |
| Usage in medical products | 3 |
| Notice for customers in EU nations | 4 |
| Table of contents | 5 |
| 1. General Information | 7 |
| 1.1 About these installation instructions | 7 |
| 1.2 Conventions used | 7 |
| 2. Safety Instructions | 8 |
| 2.1 Proper and Intended Usage | 8 |
| 2.2 Selection and qualification of personnel | 9 |
| 2.3 Notice on safety during operations | 10 |
| 2.4 Product labelling | 11 |
| 3. Possible Combinations | 12 |
| 4. Description | 13 |
| 4.1 Components | 13 |
| 5. Technical Specifications | 15 |
| 6. Installation | 17 |
| 6.1 Safety notices to observe during installation | 17 |
| 6.2 Installation procedure | 18 |
| 7. Operating Notes | 26 |
| 7.1 General information | 26 |
| 7.2 Changing and connecting the batteries | 28 |
| 8. Troubleshooting | 30 |
| 9. Maintenance | 31 |
| 9.1 Maintenance | 31 |
| 9.2 Cleaning and care | 32 |



| | | |
|-------------|---|-----------|
| 10. | Disposal | 33 |
| 10.1 | Packaging material | 33 |
| 10.2 | Components in the ECS control unit | 33 |
| 10.3 | Batteries | 33 |
| | EU Declaration of Conformity | 34 |
| | Additional information | 35 |
| | Additional information | 36 |

1. General Information

1.1 About these installation instructions

In order to install the ECS control unit successfully and safely in the end product, these installation instructions must be observed. These instructions are not an operating manual for the end product.

These instructions will help you to minimize danger, repair costs and down times. They will also help you to maximize the reliability and lifespan of the end product.

| |
|---|
|  CAUTION |
|  <p>The notices in these instructions must be followed! Following the guidelines during installation and connection procedures will help to minimize:</p> <ul style="list-style-type: none"> • the risk of accident and injury, and • damage to the ECS control unit or the end product. |

These installation instructions have been written with due care and attention. However, we cannot guarantee that the data, images and drawings are complete and correct nor do we accept any liability for the information contained therein, unless required by law.



- ▶ We reserve the right to make unannounced technical changes in the course of our continual product improvement process!



1.2 Conventions used



Notices which do not relate to safety are indicated in these instructions with a symbol:

- ▶ Triangular notice symbol

Explanations of warning notices

| |
|--|
|  WARNING |
|  <p>WARNING indicates a hazardous situation which, if not avoided, could result in death or serious injury.</p> |

| |
|---|
|  CAUTION |
|  <p>CAUTION indicates a hazardous situation which, if not avoided, could result in minor or moderate injury.</p> |



| |
|--|
|  NOTICE |
|  <p>NOTICE is used to address practices which are not related to personal injury but may result in damage to the product or surroundings.</p> |

2. Safety Instructions

2.1 Proper and Intended Usage



The ECS control unit is intended to be used as a control unit and power supply for the appropriate DewertOkin drive systems in use



- for care purposes,
- or in hospitals.

| |
|---|
|  CAUTION |
|  |
| The ECS control unit should only be used for the applications described above. Any other form of usage is not permitted and can lead to accidents or destruction of the unit. Such non-approved applications will lead immediately to the expiration of all guarantee and warranty claims on the part of the end-product manufacturer against the manufacturer. |

2.1.1 Improper usage

Be sure to follow the notices below concerning improper usage. You should include them in your product manual in order to inform the users of your end product.

| |
|---|
|  WARNING |
|  |
| The ECS control unit must not be used: <ul style="list-style-type: none"> • in any environment where combustible or explosive gases or vapours (e.g., anaesthesiology) may be present, • in the proximity of open fires or other heat sources (such as furnaces, ovens or direct sunlight), • as a power source for toys or games, • in any application that will be cleaned with an automated washing system, • in a moist environment, or • outdoors. |

| |
|--|
|  CAUTION |
|  |
| The ECS control unit may not be operated by: <ul style="list-style-type: none"> • by small children, • by frail or infirm persons without supervision, or • in the proximity of small children. |

The ECS control unit can be used by children of 8 years and older, persons with reduced physical, sensory or mental capabilities, or persons with lack of experience or knowledge when they are supervised or instructed concerning the safe use of the device and when they understand the resulting risks. Do not allow children to play with this device. The cleaning and user maintenance must not be carried out by children without supervision.

- ▶ You should only use spare parts which have been manufactured or approved by DewertOkin. Only these parts will guarantee a sufficient level of safety.



Using the drive systems in medical applications

This DewertOkin product is in compliance with the safety requirements found in IEC 60601-1.

We strongly recommend that the end product (including all its components) which you are manufacturing for a medical application should also be in compliance with the safety requirements found in IEC 60601-1.

You should make sure that the mechanical movement of the motor in your end product poses no risk of injury. Conduct a risk analysis for the end product for this purpose. You should also include safety notices in the instructions for the end product and technical safeguards in your product to eliminate any risk.

Battery-operated reset function

| | |
|---|--|
|  |  CAUTION |
| The battery-operated reset function is not a safety system and does not avert danger. | |

DewertOkin does not guarantee that the drive will function in the event of a power outage.

If the end-product manufacturer chooses to guarantee the functionality of the end product during a power outage, then the end-product manufacturer is responsible for arranging a mechanism to ensure this functionality.

2.2 Selection and qualification of personnel

This ECS control unit should only be installed into the end product by someone who has completed training in electronic motor assembly or has equivalent qualifications.

You should only install the ECS control unit when you are qualified to do so. Otherwise, a properly qualified person should be found for this task.

2.3 Notice on safety during operations

Basic safety rules must be followed in order to ensure that the end product can be continually operated in a safe manner. These rules must be observed while using the end product and while installing the ECS control unit.

These rules and safety measures can be categorized as follows:

- Construction measures before the installation (refer to the "Ensuring operational reliability during installation" section in Chapter "Installation").
- Safety fundamentals during the installation of the ECS control unit and during cable and wire routing (refer to the "



Electrical connection" section in the "Installation" Chapter).

- Basic safety rules during operation (refer to the "Operating Notes" Chapter).
- The creation of a manual for the end product which contains these and other safety rules.

2.3.1 Creating a user's manual

The manufacturer of the end product must create a manual for the users of that product. The safety notices in the end-product manual must be written based on the end product's risk assessment.

2.3.2 Electrical safety

| | |
|---|--|
|  |  CAUTION |
| | Be careful; there is a risk of electrical shock! Be sure to unplug the power cord on the ECS control unit before you begin assembly! |

The ECS control unit must not be opened! You must properly dispose of malfunctioning or broken units.

2.4 Product labelling

2.4.1 Ratings plate (type label)

A ratings plate on each ECS control unit specifies the exact name and serial number of the ECS control unit. It also states the technical specifications valid for that particular control unit. The following illustration shows where the specifications are located on the ratings plate of the ECS control unit.

- ▶ The ratings plate shown is an example; the specifications for ECS control unit may differ from this illustration.

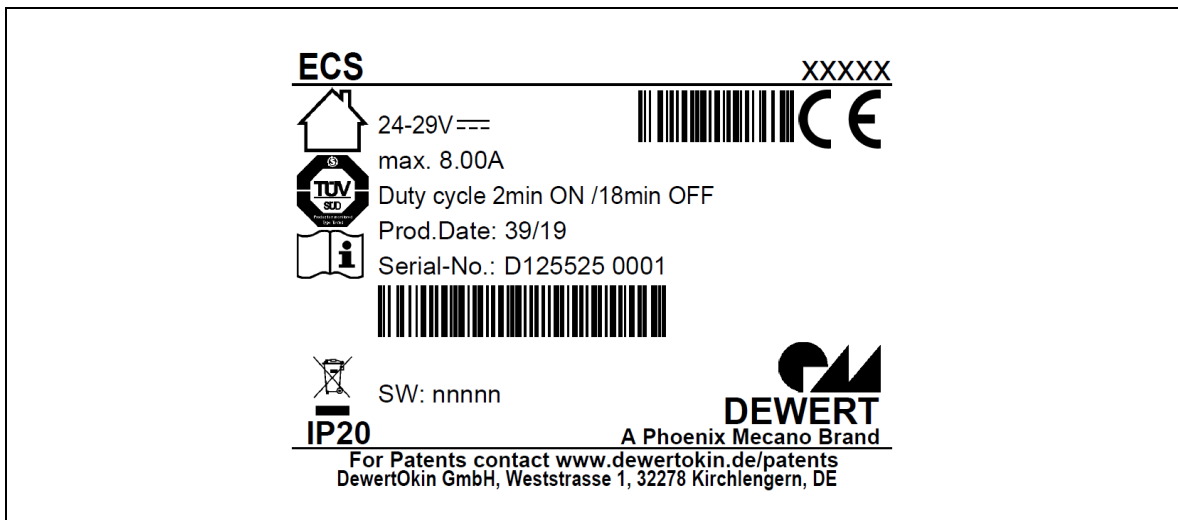





Figure 2 Ratings plate example for the ECS control unit

| | |
|---|---|
| ECS | Model name |
| xxxxx | Article number |
| 24–29V === | Input voltage |
| max. 8.00A | Current consumption |
| Duty cycle 2min ON /18min OFF | Intermittent operations: 2 minutes / 18 minutes |
| Prod.Date | Calendar week / year |
| Serial-No. | Serial number of the ECS control unit |
| IPX4 | Protection degree |
| SW: nnnnn | Software number |
|  | Use in dry rooms only! |
|  | Follow all special disposal instructions! |
|  | Conformity mark |

3. Possible Combinations

The ECS control unit can be combined with one or more drives. The following basic combinations are possible:

- One Megamat MCZ EASY drive plugged into the ECS control unit, and a connected PD14/PD15 power supply with IPROXX2 handset.
- One Megamat MCZ EASY drive plugged into the ECS control unit and a connected PD14/PD15 power supply, and up to three additional drives with an IPROXX2 handset.

Systems can be customized by combining drives, control units, power supplies and IPROXX2 handsets as needed.

DewertOkin has separate system instruction manuals containing the additional information and instructions needed for these systems. You can also find more information at www.dewertokin.de.

4. Description

The ECS control unit is used for power supply and control for one or more DewertOkin drives. The connecting cable is used to connect the ECS control unit to the PD14/PD15 power supply.

- ▶ We reserve the right to make unannounced technical changes in the course of our continual product improvement process!

4.1 Components

The housing of the ECS control unit has a connection for the power feed-in and connections for the drives and IPROXX2 handset. The connection for the drive/handset is fitted with a covering mechanism to guard against accidental unplugging. An MCZ EASY drive can be attached to the ECS control unit.

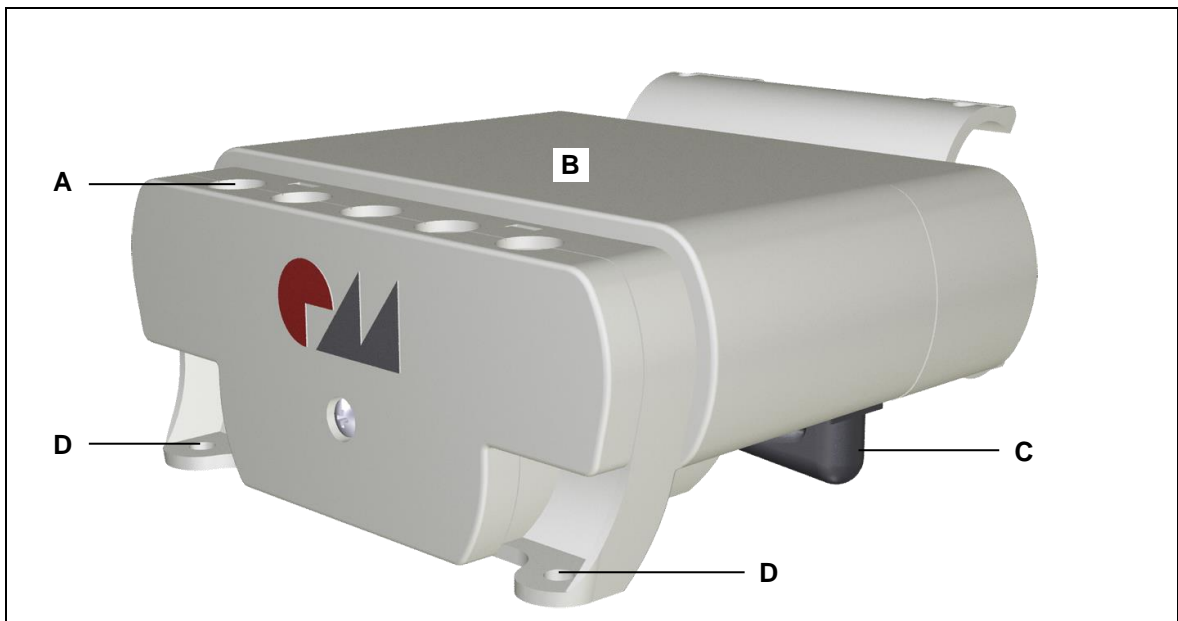

Figure 3 Components for the ECS control unit

- | | |
|---|--|
| A Cover for the connecting cables (drives and IPROXX2 handset) | B ECS Control Unit |
| C Connecting cable to the PD14/PD15 power supply | D Screw-on mount to the end product |

4.1.1 Attachment to the drive

Two mounting clamps are used to attach the ECS control unit to the Megamat MCZ EASY drive.

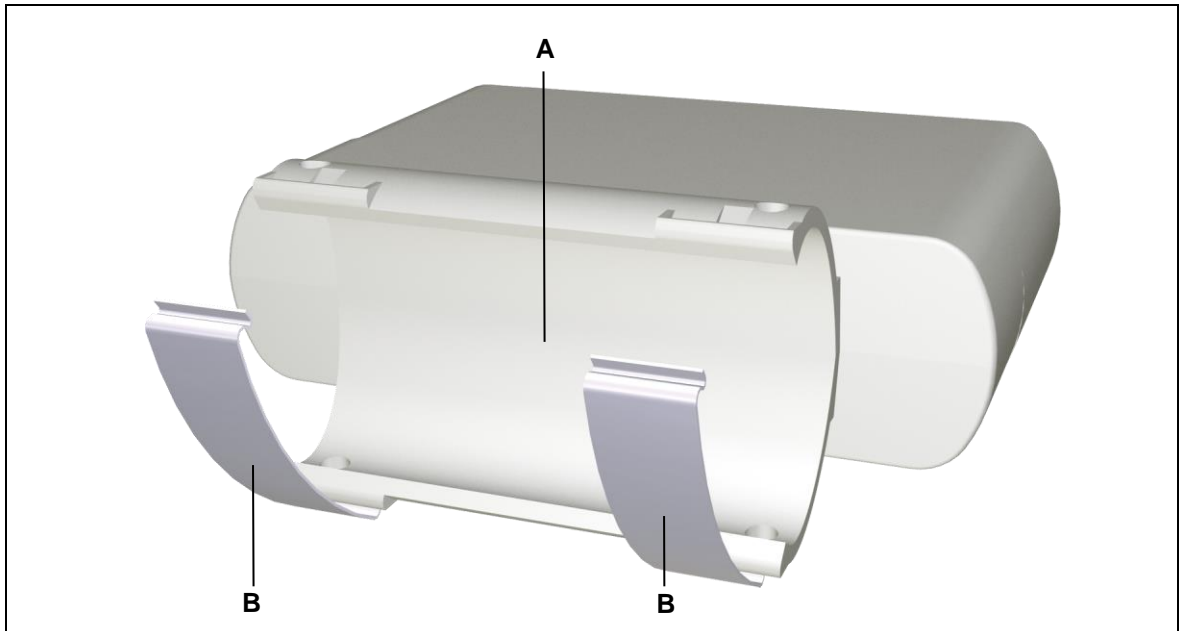

Figure 4 Attaching the drive

A Drive support

B Mounting clamp

4.1.2 Connecting plug



Figure 5 LSP plug to the connecting cable

A Connecting cable to the PD14/PD15 power supply

B LSP plug

5. Technical Specifications

| | |
|--|---|
| Input voltage | 24 V DC – 29 V DC |
| Current consumption at nominal operations | Max. 8 A |
| Mode of operations ¹⁾ | Intermittent duty 2 min./18 min. |
| Protection class ²⁾ | III |
| Permitted current consumption of all additional drives ³⁾ | Max. 8 A (depending on version) |
| Protection degree | IPX4 |
| Colours | Grey |
| Dimensions and weight | |
| Length x width x height | 141 mm x 130 mm x 67 mm |
| Weight | Approx. 550 g |
| Electrical reset function that does not use mains power supply (optional) | |
| Voltage | Two nine-volt batteries (6LR61) |
| Ambient conditions for operation, storage and transport | |
| Transport / storage temperature | From -20 °C to +50 °C From -4 °F to +122 °F |
| Operating temperature | From +10 °C to +40 °C From +50 °F to +104 °F |
| Relative humidity | From 30% to 75% |
| Air pressure | From 800 hPa to 1060 hPa |
| Height | < 2000 m |

¹⁾ Mode of operation: intermittent duty 2 min./18 min. This means that after the unit is operated with its rated load for up to two minutes it must then be paused for 18 minutes. The system can malfunction if this pause is not observed!

²⁾ Safety extra low voltage

³⁾ No more than two drives may be operated at rated load simultaneously!

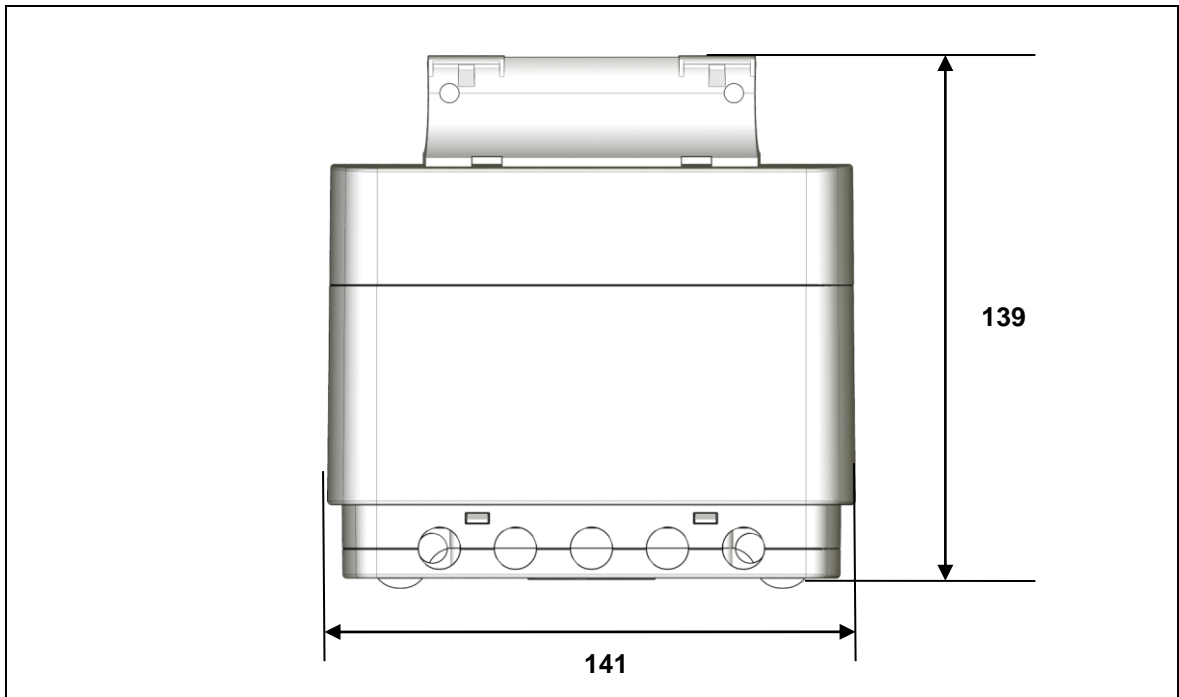

Figure 6 Dimensions of the ECS control unit, top view (in mm)



Figure 7 Dimensions of the ECS control unit, front view (in mm)

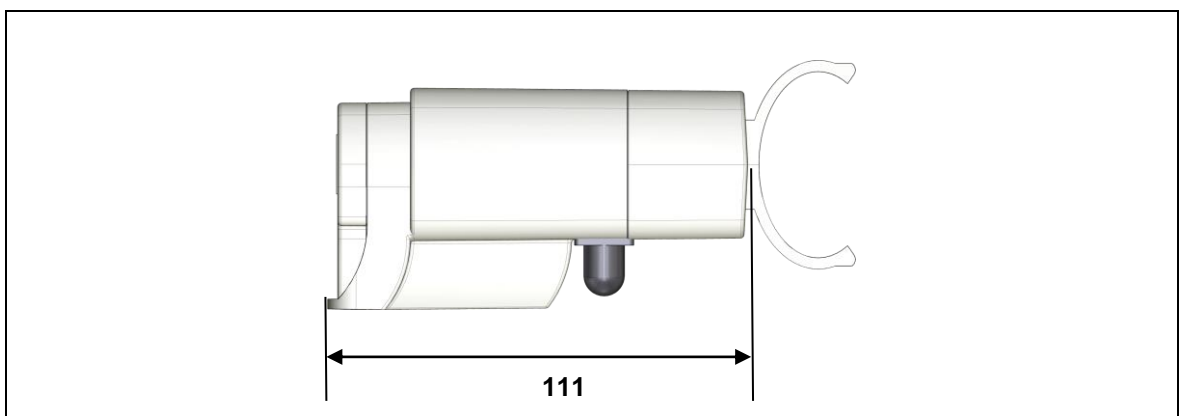

Figure 8 Dimensions of the ECS control unit, side view (in mm)

6. Installation

6.1 Safety notices to observe during installation

Basic safety rules must be followed in order to ensure that the end product can be continually operated in a safe manner. These rules must be observed while using the end product and while installing the ECS control unit.

6.1.1 Avoiding electrical faults

The connecting cable is designed to connect the power supply through the PD14/PD15 power supply. When sizing your end product, remember that the connecting cable must never be squashed (e.g. by moving over it) during operations.

6.1.2 Ensuring operational reliability during installation

The safety and reliability of the end product containing DewertOkin components can be ensured by using the proper construction methods described below.

Installation dimensions for the Megamat MCZ EASY drive

The installation dimensions for Megamat MCZ EASY drive must not be smaller than a specific size. The drive or drive control unit could be mechanically damaged if the installation length is shorter than this. The installation size is specified below:

- Megamat MCZ EASY: at least 285 mm.

Mechanical construction

A plug cover protects the connections from mechanical damage and minimizes the risk of accidental unplugging.

6.2 Installation procedure

Before installing the ECS control unit, make sure that you are observing all of the safety notices found in the "Safety notices to observe during installation" section.

6.2.1 Installation and dismounting for the control unit

There are four mounting holes in the ECS control unit which can be used to attach it to the end product with the appropriate screws (for example, 4.5 mm x 30 mm screws: DIN 7981). The ECS control unit should be mounted so that it lies flat against its supporting material. In the end product, no mechanical forces (such as torsion) should be put on the ECS control unit or its housing. Such forces could lead to damage (such as cracks) in the housing.

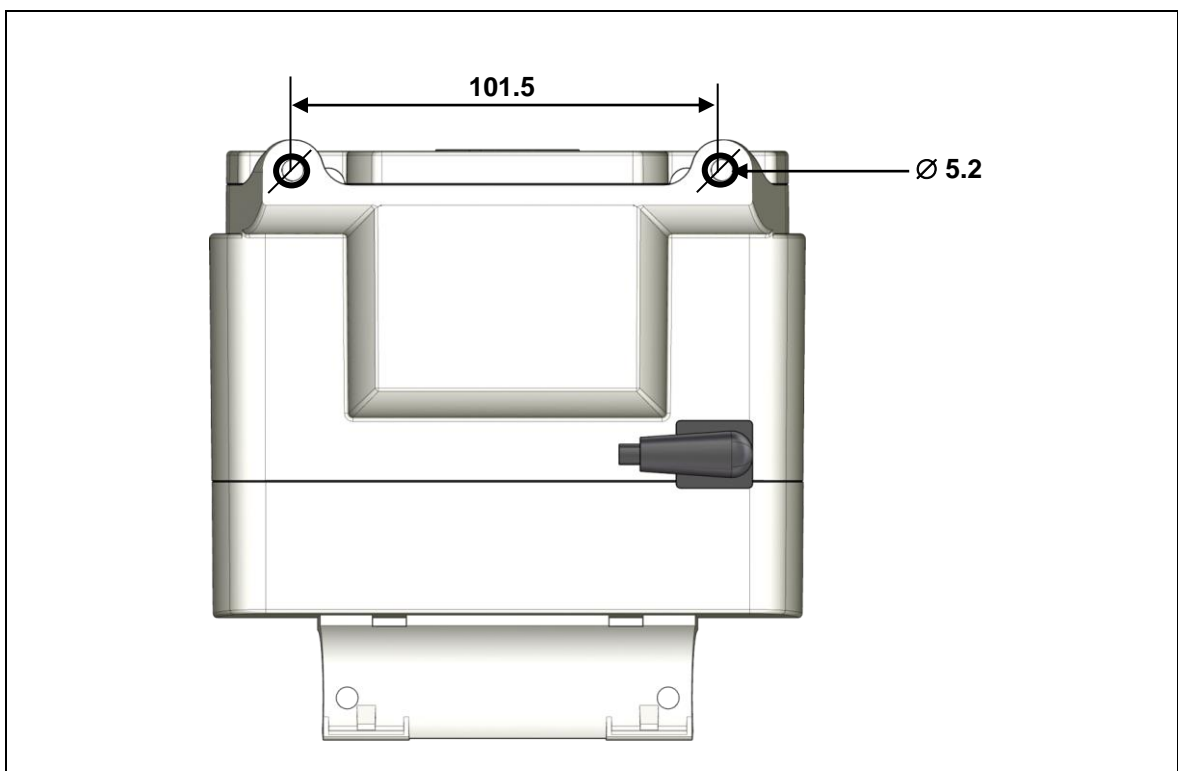



Figure 9 ECS control unit mounting points (in mm)

6.2.2 Attaching the ECS control unit to the Megamat MCZ EASY drive

| | |
|---|--|
| NOTICE | |
|  | <p>The installation length for the Megamat MCZ EASY drive must not be less than 285 mm. The drive or drive control unit could be mechanically damaged if the installation length is shorter than this.</p> |

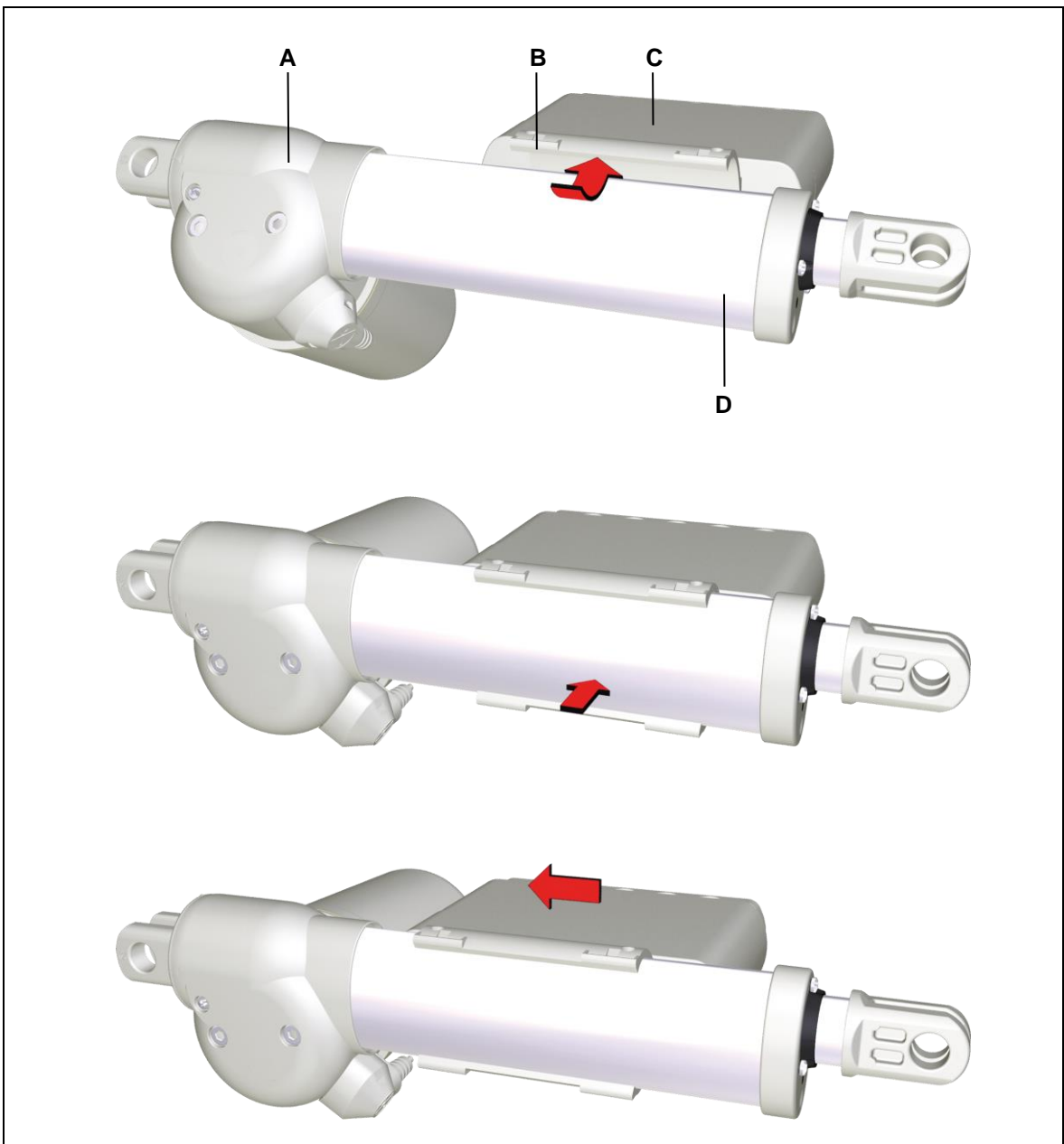

Figure 10 Attaching the ECS control unit to the Megamat MCZ EASY drive

- | | |
|---|---|
| <p>A Megamat MCZ EASY</p> <p>C ECS control unit</p> | <p>B Attachment to the guidance profile</p> <p>D Guidance profile</p> |
|---|---|

Two mounting clamps are used to attach the ECS control unit to the Megamat MCZ EASY drive. The mounting clamps engage into the mount on the guidance profile (**B**).

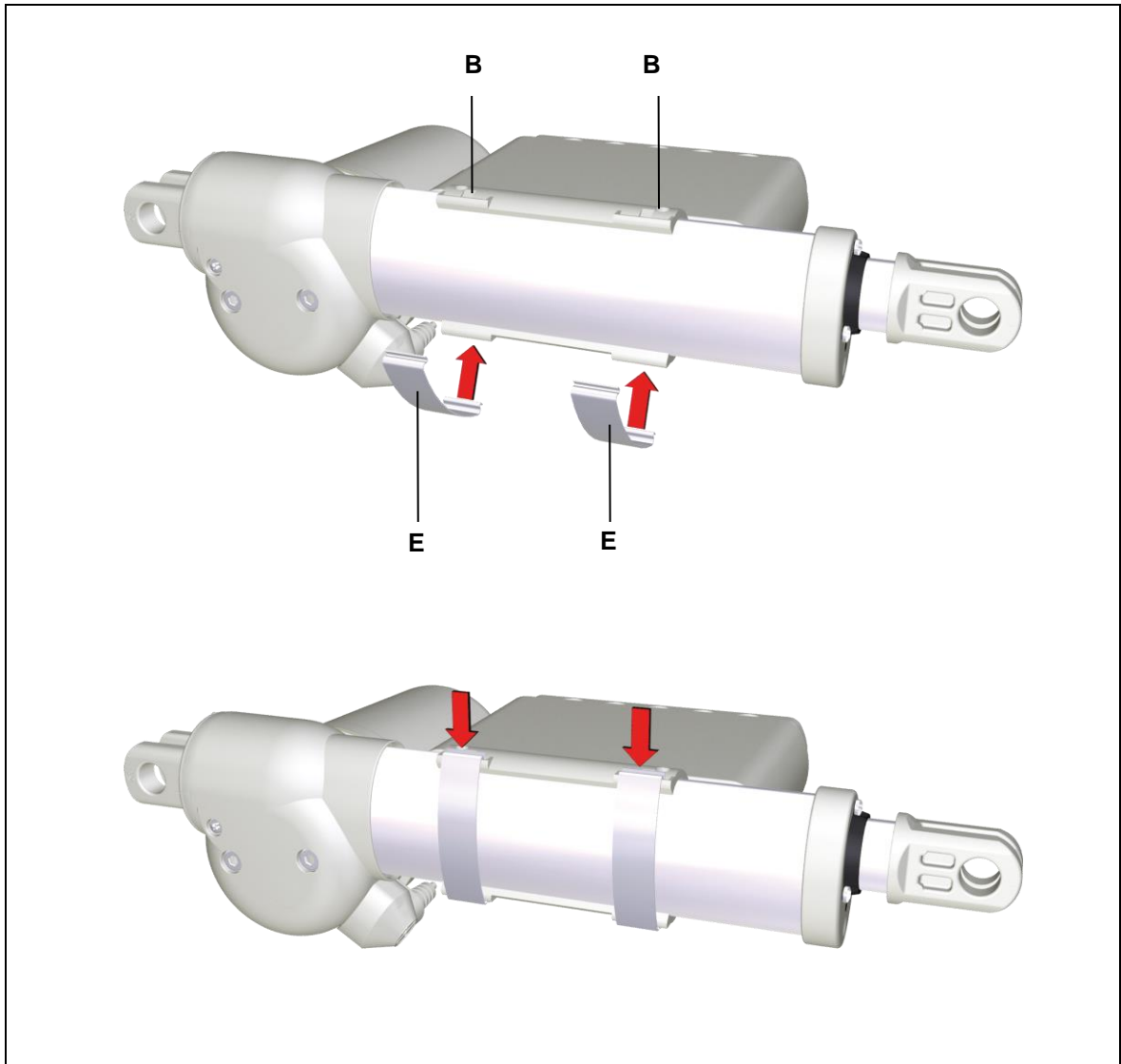

Figure 11 Attaching the mounting clamps

A Mounting clamps

Optional variant: Installing the strain relief cable grip for the ECS control unit on the end product

The strain relief for the ECS control unit's power cable is installed on the end product as shown in Figure 12.

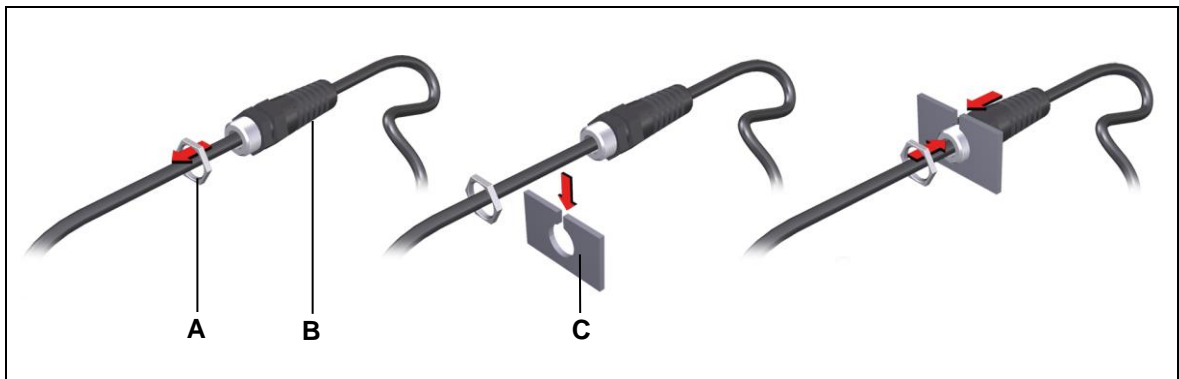

Figure 12 Mounting the strain relief cable grip (an example application)

A Hex nuts

B Strain relief

C End product (with slot for cable entry) that the strain relief mechanism will be attached to.

- 1 Unscrew the flat hex nut (**A**).
- 2 Insert the strain relief (**B**) through the slot in the hole in the end product (**C**).
- 3 Tighten the hex nut (**A**) back onto the strain relief cable grip.

Optional variant: Route the connecting cable through the ECS control unit's strain relief cable grip.

The method for routing the connecting cable through the cable grip of the ECS control unit is shown in Figure 13.

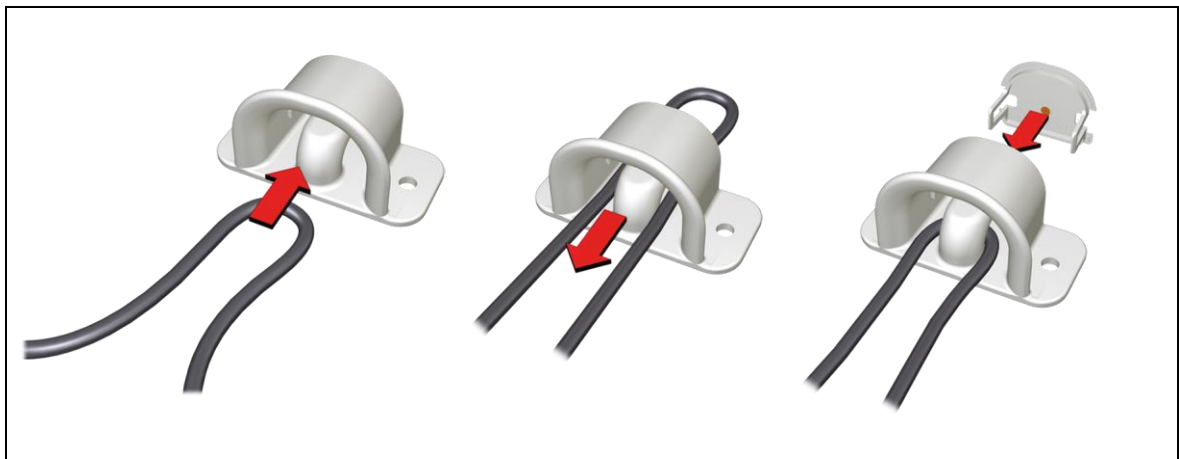





Figure 13 Routing the connecting cable through the mounted cable grip

- 1 Take a loop of the connecting cable and guide it through the strain relief cable grip, as shown in Figure 13.
- 2 Pull the cable slightly forward.
- 3 Put the cap onto the cable grip. The cap must snap on properly.

6.2.3 Electrical connection

| | |
|---|--|
|  |  CAUTION |
| | Electrical components should be connected or disconnected only when the power supply cord (connecting cable) is unplugged. |

| | |
|---|--|
|  | NOTICE |
| | There is a delay after the supply voltage is applied before the device actually turns on. Wait at least seven seconds before start up. |

Routing the electrical cables

When routing the cables, be sure that:

- the cables cannot get jammed,
- no mechanical load (such as pulling, pushing or bending) will be put on the cables, and
- the cables cannot be damaged in any way.

Fasten all cables (especially the connecting cables) to the end product using sufficient kink prevention methods. Be sure that the design of the end product prevents the connecting cables from coming into contact with the floor during transport.

Connecting the Megamat MCZ EASY to the ECS control unit

The electrical connection from the Megamat MCZ EASY to the ECS control unit is made by plugging the drive plug into the ECS control unit.

Take off the cover (refer to the "

Opening the cover" section) and plug the drive plug into the proper socket.

Opening the cover



Figure 14 Opening the cover on the ECS control unit

- 1 Unplug the cable from the PD14/PD15 or disconnect the PD14/PD15 power supply from the socket.

| | |
|--|--|
| | CAUTION |
| | You should only connect and disconnect the cables when they are completely disconnected from any live current! |

- 2 Remove the screw from the cover.
- 3 Tilt the cover forward.
- 4 You can now plug in or unplug a plug. Be sure to use the proper socket.

Connecting the ECS control unit to the PD14/PD15 power supply

The power cable between the ECS control unit and the PD14/PD15 power supply is connected as shown in Figure 15.

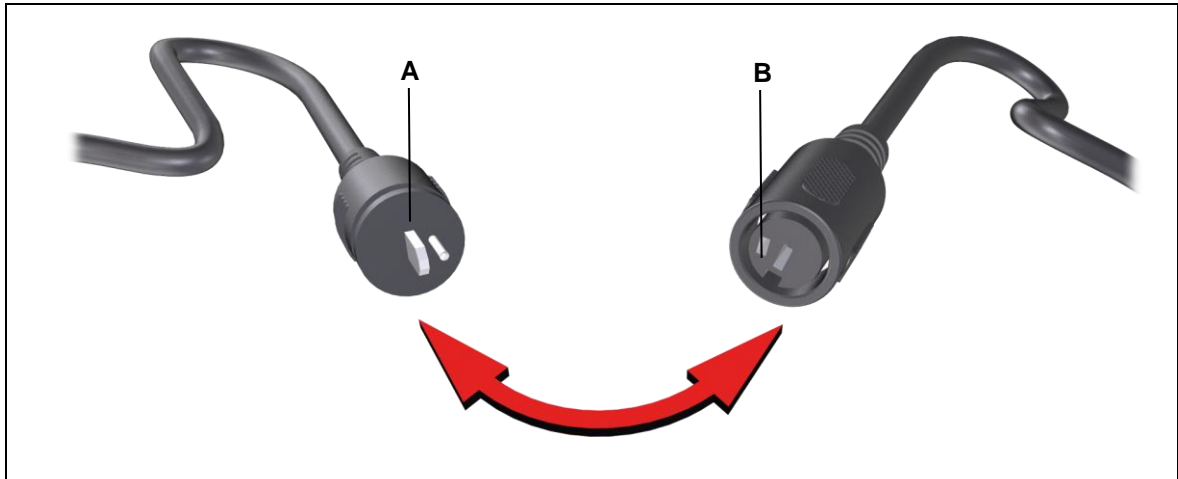

Figure 15 Connecting the ECS control unit to the PD14/PD15 power supply

A LSP plug from the ECS control unit

B LSP socket for the PD14/PD15 power supply

6.2.4 Disconnecting the ECS control unit



1 Unplug the power cable's plug from the PD14/PD15 power supply.

| | | |
|--|--|----------------|
| | | CAUTION |
| | You should only connect and disconnect the cables when they are completely disconnected from any live current! | |

- 2 Open and remove the cover (refer to Figure 14).
- 3 Disconnect all connecting cables from the ECS control unit.
- 4 Loosen both of the mounting clamps on the ECS control unit (refer to Figure 11).
- 5 Remove the ECS control unit from the Megamat MCZ EASY drive.

7. Operating Notes

The factual information contained within may be used when you are creating the end-product manual. The installation instructions do not contain all information required for the safe operation of the end product. They only describe the assembly and operation of the ECS control unit as a partially assembled piece of machinery.

| | |
|---|--|
|  |  CAUTION |
| | When creating the operating instructions, remember that the installation instructions are intended for qualified specialists and are not for typical users of the end product. |

7.1 General information

- ▶ Only DewertOkin's Megamat MCZ or Megamat MCZ EASY drives should be connected to the ECS control unit since they have already been verified to work together.

Delayed start-up

After plugging the power plug into the power outlet:



| | |
|---|--|
|  | NOTICE |
| | There is a delay after the supply voltage is applied before the device actually turns on. Wait at least seven seconds before start up. |

Power-on time / intermittent operations

The ECS control unit has been designed for intermittent operations. Intermittent operation is an operational mode where the drive must pause after a specified maximum period of operation (power-on time). This protects the drive from overheating. Extreme overheating can cause a malfunction.

- ▶ The ratings plate on the drive specifies the maximum power-on time and the required pause intervals.



Avoiding electrical risks

| | |
|---|--|
|  |  CAUTION |
| | Make sure that all live (current-carrying) parts of the drive system and power supply cannot be touched. In particular, be sure that unused power and control unit connections are covered adequately. |

Avoiding overheating



| | |
|---|---|
|  | NOTICE |
| | No more than two drives may be operated at rated load simultaneously! |

Emergency shut off of a connected drive or control unit

| | |
|---|--|
|  |  CAUTION |
| | In an emergency, disconnect the PD14/PD15 power supply from the main power supply (unplug the PD14/PD15 power supply from the power outlet). This power outlet must be accessible at all times during operation so that the cable can be unplugged. Or you can disconnect the plug on the ECS control unit from the PD14/PD15 power supply. This will shut down the connected drive. |

Avoiding cable damage



Be sure that your operating instructions inform the user about the possible cable risks.

| | |
|---|---|
|  |  CAUTION |
| | The cables (particularly the connecting cable) should not be run over. In order to prevent injuries or damage to the drive and ECS control unit, no mechanical strain should be placed on the cables. |



7.2 Changing and connecting the batteries

- ▶ The batteries are delivered only with versions that feature the "electrical reset" function.

The battery-operated reset function allows the drive system to be operated during a power outage. Two nine-volt batteries can be used to power the control unit in the event of a power outage. The batteries should be connected only then when the outage occurs. The batteries are not connected by default since they have very limited capacity. They can only be used to power the reset function once. The used batteries should then be replaced and properly disposed of.

| | |
|---|--|
|  |  CAUTION |
| | The battery-operated reset function is not a safety system and does not avert danger. |

| | |
|--|--|
|  | NOTICE |
| | Both batteries should be replaced/inserted at the same time. Use batteries of similar: <ul style="list-style-type: none">• age,• type and• manufacturer. |

| | |
|---|---|
|  |  CAUTION |
| | Connect the nine-volt batteries first when you would like to perform a battery-operated reset. Remove the batteries after carrying out an adjustment operation. Discard these batteries and insert new batteries. |

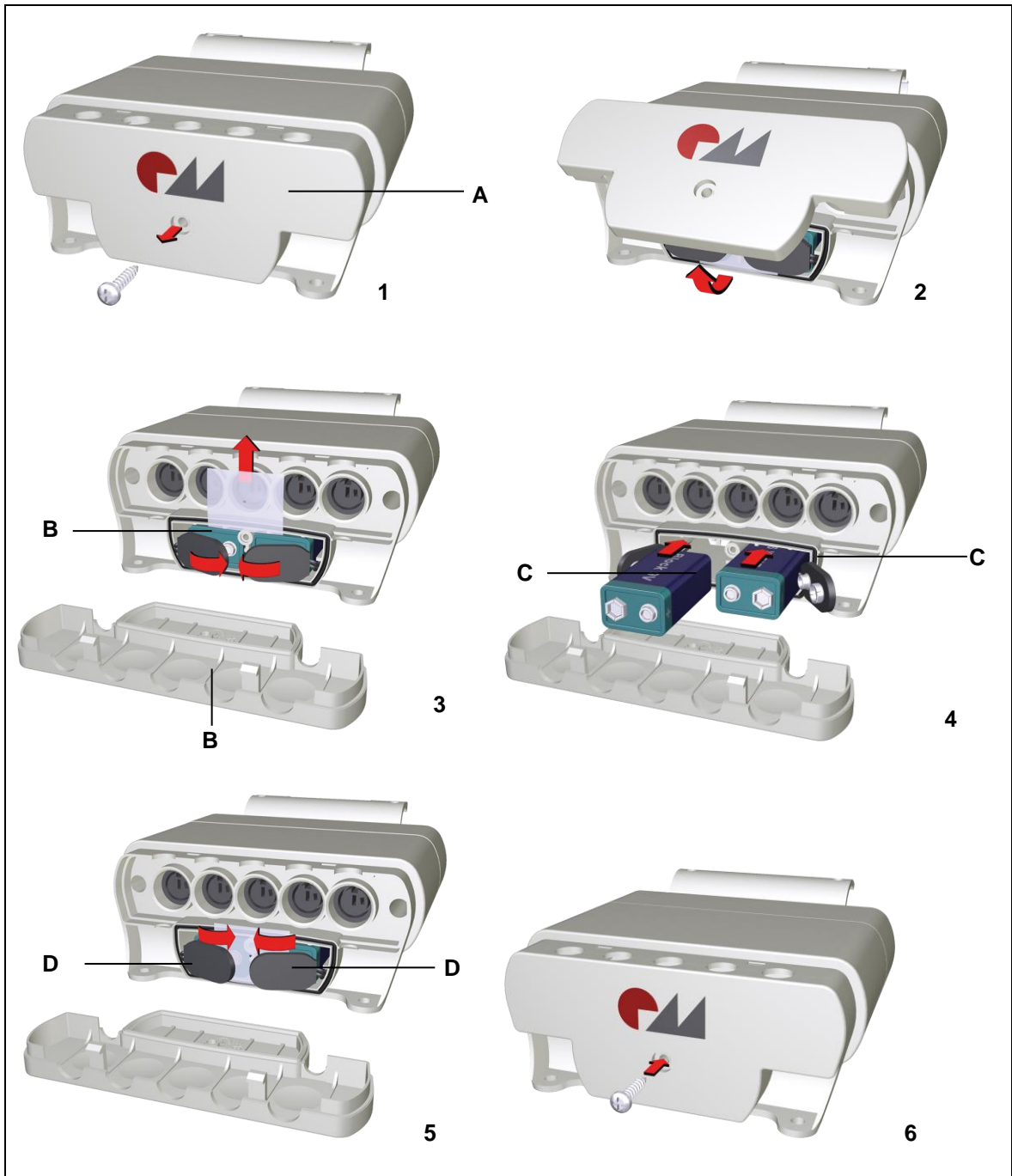



Figure 16 Connecting the nine-volt batteries

A Covering **B** Battery compartment **C** Two nine-volt batteries (6LR61) **D** Battery clip

- 1 Open the cover. There are two nine-volt batteries in the battery compartments.
- 2 Remove the protective film between two clips and the battery terminals.
- 3 Connect the batteries. The reset functionality is now enabled.
- 4 New batteries must be inserted after the reset function has been carried out. Be sure to place the protective films back in position between clips and battery terminals.
- 5 Close the pull-out guard and screw it down securely.

8. Troubleshooting

This chapter describes troubleshooting methods for fixing problems. If you experience an error that is not listed in this table, please contact your supplier.

| | |
|---|--|
|  |  CAUTION |
| | <p>Only qualified specialists who have received electrician training should carry out troubleshooting and repairs.</p> |

| Problem | Possible cause | Solution |
|--|--|--|
| The drive or control unit is not functioning. | There is no mains supply voltage. | Connect the mains power. |
| | The drive or control unit is defective. | Please contact your supplier or sales agent. |
| | | Make sure the batteries are connected. |
| The drive is suddenly not capable of movement. | The overheating protection or system protection has been triggered. | Remove the overload (change or remove the load). Allow the system to rest for 20 to 30 minutes with the mains power unplugged. If this does not resolve the problem, contact your supplier or distributor. |
| | The unit's fuse may have been triggered. | Please contact your supplier or sales agent. |
| | There is no mains supply voltage. | Connect the mains power. |
| | A cable has been disconnected (to mains power, drive or control keypad). | Check the cables and reinsert them, if required. |
| The battery-operated reset is not functioning. | The batteries are empty. | Check the batteries and replace if necessary. |
| | The batteries are not connected. | Connect the batteries. |

9. Maintenance

- ▶ You should only use spare parts which have been manufactured or approved by DewertOkin. Only these parts will guarantee a sufficient level of safety.

9.1 Maintenance

| Type of check | Explanation | Time interval |
|---|---|---|
| Check the function and safety of the electrical system. | A qualified electrician should carry out this inspection. (Refer to the "Electrical connection" section in the "Installation" Chapter.) | Periodic inspections can be carried out at intervals based on the risk assessment which you conduct for your end product. |
| Look over the housing periodically for any signs of damage. | Check the housing for breaks or cracks. | At least every six months. |
| Look over the plug-in connections and electrical access points for signs of damage. | Check that all electrical cables and connections are firmly seated and correctly positioned. | At least every six months. |
| Look over the cables for any signs of damage. | Check the connecting cables for pinching or shearing. Also check the strain relief and kink protection mechanisms, in particular after any mechanical load. | At least every six months. |

9.2 Cleaning and care

The ECS control unit is easy to clean. Its smooth surfaces simplify the cleaning process.

| | |
|---|---|
|  | NOTICE |
| | Never clean the ECS control unit in an automated washing system or with a high-pressure cleaner. Do not allow fluids to penetrate the lighting. Damage to the system could result. Do not use a cleanser that contains benzene, alcohol or similar solvents. |

- 1 Unplug the power cable between the ECS control unit and the PD14/PD15 power supply before you clean the unit.

| | |
|---|--|
|  | CAUTION |
| | Battery-operated reset function: Disconnect the nine-volt block batteries. |

- 2 Clean the ECS control unit with a moist cloth.
- 3 Be sure that you do not damage the connecting cables during the cleaning.

10. Disposal

10.1 Packaging material

The packaging material should be sorted into recyclable components and then disposed of in accordance with the appropriate national environmental regulations (in Germany according to the recycling law KrWG from 01.06.2012; internationally according to the EU Directive 2008/98/EC (Waste Framework Directive WFD as of 12.12.2008)).

10.2 Components in the ECS control unit

The ECS control unit consists of electronic components, cables and metal and plastic parts. You should observe all corresponding national and regional environmental regulations when disposing of the ECS control unit.

The disposal of the product is regulated in Germany by Elektro-G, internationally by the EU Directive 2012/19/EC (WEEE), or by any applicable national laws and regulations.



The ECS control unit should not be disposed of with normal household waste!

10.3 Batteries

The disposal of the batteries is regulated in the EU by Battery Directive 2006/66/EC, in Germany by the BattG battery law of 25.6.2009, and internationally by any applicable national laws and regulations.



These batteries should not be disposed of with normal household waste!

EG-Konformitätserklärung

Nach Anhang IV der EMV-Richtlinie 2014/30/EU

Nach Anhang IV der EU-Niederspannungsrichtlinie 2014/35/EU

Nach Anhang VI der RoHS-Richtlinie 2011/65/EU (inkl. Delegierte Richtlinie (EU) 2015/863)

Der Hersteller

DewertOkin GmbH
Weststraße 1
32278 Kirchlengern
Deutschland - Germany

erklärt hiermit, dass das Produkt

EU Declaration of Conformity

In compliance with Appendix IV of the EMC-Directive 2014/30/EU

In compliance with Appendix IV of the LVD-Directive 2014/35/EU

In compliance with Appendix VI of the EU RoHS Directive 2011/65/EU (incl. Commission delegated Directive (EU) 2015/863)

The manufacturer:

declares that the following product

ECS

die Anforderungen folgender EG-Richtlinien erfüllt:

Richtlinie über elektromagnetische Verträglichkeit 2014/30/EU

Niederspannungsrichtlinie 2014/35/EU

DELEGIERTE RICHTLINIE (EU) 2015/863 DER KOMMISSION vom 31. März 2015 zur Änderung von Anhang II der Richtlinie 2011/65/EU des Europäischen Parlaments und des Rates hinsichtlich der Liste der Stoffe, die Beschränkungen unterliegen.

Angewendete Normen

meets the requirements of the following EU directives:

Electromagnetic Compatibility Directive 2014/30/EU

Low Voltage Directive 2014/35/EU

COMMISSION DELEGATED DIRECTIVE (EU) 2015/863 of 31 March 2015 amending Annex II to Directive 2011/65/EU of the European Parliament and of the Council as regards the list of restricted substances.

Applied standards:

- EN 60335-1:2012/A11:2014
- EN 55014-1:2006/A1:2009/A2:2011
- EN 55014-2:1997/A1:2001/A2:2008
- EN 61000-3-2:2014
- EN 61000-3-3:2013
- EN 62233:2008

Konstruktive Änderungen, die Auswirkungen auf die in der Montageanleitung angegebenen technischen Daten und den bestimmungsgemäßen Gebrauch haben, das Produkt also wesentlich verändern, machen diese Konformitätserklärung ungültig!

This declaration of conformity is no longer valid if constructional changes are made which significantly change the drive system (i.e., which influence the technical specifications found in the instructions or the intended use)!



Kirchlengern, Germany 24 September 2019

Dr.-Ing. Josef G. Groß
Geschäftsführer / Managing Director

Additional information

ECS control unit

The following standards and norms were used in the versions¹⁾ with at least IPX4 and higher - in according to:

- EN 60601-1:2006 + A1:2013, IEC 60601-1:2005 + A1:2012 (short description: Edition 3.1), Medical electrical equipment.

EN 60601-1-2:2015, IEC 60601-1-2:2014 (short description: Edition 4.0), EMC

| | |
|------------------------------|--|
| IEC/EN 60601-1, Section 4 | General requirements |
| IEC/EN 60601-1, Section 6 | Classification |
| IEC/EN 60601-1, Section 7.1 | Labelling – general |
| IEC/EN 60601-1, Section 7.2 | Labelling – inscriptions |
| IEC/EN 60601-1, Abschnitt 8 | Protection against electrical danger, leakage currents |
| IEC/EN 60601-1, Section 11.1 | Overheating protection |
| IEC/EN 60601-1, Section 11.2 | Fire prevention |
| IEC/EN 60601-1, Section 11.3 | Design requirements for fire-resistant housing |
| IEC/EN 60601-1, Section 13 | Dangerous situations and error conditions |
| IEC/EN 60601-1, Section 15.3 | Mechanical attachment |
| IEC/EN 60601-1, Section 15.4 | Components and general construction |
| IEC/EN 60601-1, Section 17 | Electromagnetic compatibility |

Additional information

ECS control unit

The following standards and norms were used in the versions¹⁾ with at least IPX4 and higher - in according to:

- EN 60601-2-52, IEC 60601-2-52, (Particular requirements for the safety and essential performance of medical beds)

| | |
|---|--|
| IEC/EN 60601-2-52, Section 201.6.2 | Protection against electrical shock: Protection class II |
| IEC/EN 60601-2-52, Section 201.7.6.3 | Control panel symbols (depending on model, customer requirements) |
| IEC/EN 60601-2-52, Section 201.9.2.2.5 | Continuous operations: Control unit only with button |
| IEC/EN 60601-2-52, Section 201.9.2.3.1 | Unintentional movement: Prevented by means of a locking mechanism (such as Control box, Supervisor, IPROXX [®] SE, IPROXX [®] , or Meditouch) |
| IEC/EN 60601-2-52, Section 201.11.1.1 | Temperature |
| IEC/EN 60601-2-52, Section 201.11.6.5.101 | Protection against water ingress |
| IEC/EN 60601-2-52, Section 201.11.8 | Loss of power: e.g. use of a battery, depending on customer requirements |
| IEC/EN 60601-2-52, Section 201.13.1.4 | Special mechanical risks, depending on customer requirements: Prevented by means of a locking mechanism (such as Control box, Supervisor, IPROXX [®] SE, IPROXX [®] , or Meditouch) |
| IEC/EN 60601-2-52, Section 201.15.3.4.1 | Mechanical strength – handset (e.g. IPROXX [®]) |
| IEC/EN 60601-2-52, Section 201.15.4.4 | Displays: Ready indicator is not required |
| IEC/EN 60601-2-52, Section BB.3.3.3 | Dimensions (depending on version and customer requirements) – handset (e.g. IPROXX [®]) |
| IEC/EN 60601-2-52, Section BB.3.4.1 | Operational forces – handset (e.g. IPROXX [®]) |

DewertOkin GmbH
Weststraße 1
32278 Kirchlengern, Germany
Tel: +49 (0)5223/979-0
Fax: +49 (0)5223/75182
<http://www.dewertokin.de>
Info@dewertokin.de

ID-No.: 78436