



MEGAMAT MPR

Installation Instructions

(Translation of the original installation instructions)

Foreword

Revisions

Version	Date	Modification, change
-	05/11	First release
(a)	07/12	Second edition
(b)	12/12	RoHS, Safety Instructions

Disclaimer and Exclusion of Liability

DewertOkin is not responsible for damage resulting from:

- failure to observe these instructions,
- changes made to this product which have not been approved by DewertOkin, or
- the use of replacement parts which have not been approved or manufactured by DewertOkin.

Address of manufacturer

DewertOkin GmbH
 Weststraße 1
 32278 Kirchlengern
 Germany
 Tel: +49 (0)5223/979-0
 Fax: +49 (0)5223/75182
<http://www.dewertokin.de>
Info@dewertokin.de

Creation of a complete operating instruction manual for the entire end product

These instructions are only intended to be used by the end-product manufacturer. They should not be given to the operator of the end product. The factual information contained within may be used as a basis when creating the end-product manual.

The warning and danger notices are best suited for use in the end product's manual. However it is not sufficient to simply follow these notices. You should also carry out an internal risk assessment for your end product. This can then be used as the basis for the safety notices in your manual.

These installation instructions do not contain all information required to safely operate the end product. They only describe the installation and operation of the drive as partially completed machinery.

The instructions are intended for the technicians responsible for manufacturing an end product and not for the operators of the end product.

Notice for customers in EU nations

German Inspection Authority (TÜV) testing label

The construction of the MEGAMAT MPR has been inspected by the German Inspection Authority (TÜV). The TÜV also monitors the production of the MEGAMAT MPR. The official German TÜV label certifies this construction inspection and production monitoring.

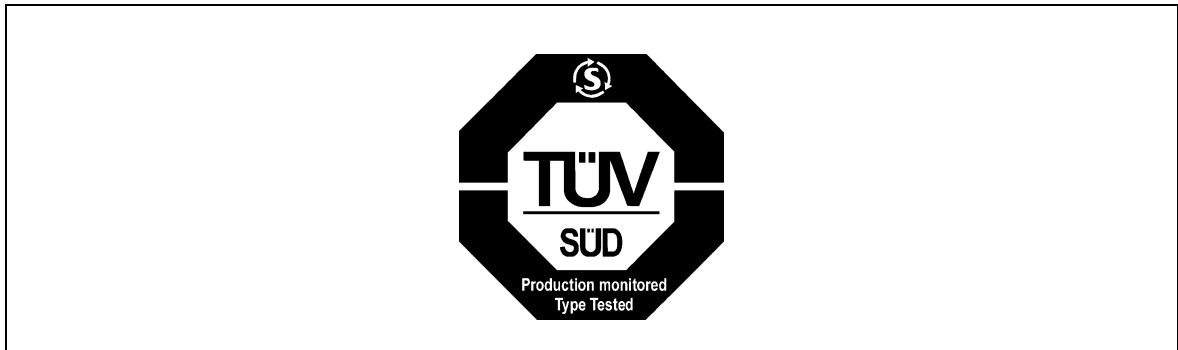

Figure 1 The TÜV label

Table of Contents

Foreword	3
Revisions	3
Disclaimer and Exclusion of Liability	3
Address of manufacturer	3
Creation of a complete operating instruction manual for the entire end product	3
Notice for customers in EU nations	4
Table of Contents	5
1. General Information	7
1.1 Configurations	7
1.2 About these installation instructions	7
1.3 Availability of this document	7
1.4 Conventions used	8
2. Safety Notices	9
2.1 Proper and Intended Usage	9
2.2 Safety notices within the installation instruction and the operating instructions for the entire machine	10
2.3 Selection and qualification of personnel	10
2.4 Notice on safety during operations	10
2.5 Product identification	11
3. Possible Combinations	13
4. Description	14
4.1 Components	14
5. Technical Specifications	15
6. Installation	17
6.1 Safety notices to observe during installation	17
6.2 Installation procedure	18
7. Operating Notes	23
7.1 General notices	23
8. Troubleshooting	25

9.	Maintenance	26
9.1	Maintenance	26
9.2	Cleaning and care	27
10.	Disposal	28
	Declaration of Incorporation/Installation	29
	EU Declaration of Conformity	30
	Additional information	31

1. General Information



1.1 Configurations

The MEGAMAT MPR drive is run in several different configurations. The "Possible Combinations" Chapter includes information about the different device combinations available.

1.2 About these installation instructions

These installation instructions must be followed closely in order to install this drive successfully and safely in the end product. These instructions are not an operating manual for the end product.

These instructions will help you to minimize danger, repair costs and down times. They will also help you to maximize the reliability and lifespan of the end product.

 CAUTION
 <p>The notices in these instructions must be followed! Following the guidelines during installation and connection procedures will help to minimize:</p> <ul style="list-style-type: none"> • the risk of accident and injury, and • damage to the drive system or the end product.

These installation instructions have been written with due care and attention. Unless otherwise required by law, we do not guarantee that the data, images and drawings are accurate or complete nor do we accept liability for their contents.

- ▶ We reserve the right to make unannounced technical changes in the course of our continual product improvement process!

1.3 Availability of this document







As manufacturer of the end product, you are obligated to comply with Machinery Directive 2006/42/EC. This directive stipulates that the installation instructions must be kept on file for governmental inspection purposes.

1.4 Conventions used

Notices which do not relate to safety are indicated in these instructions with a triangle:

- ▶ Triangular notice symbol

Safety notice explanations



	<p> DANGER</p> <p>DANGER indicates a hazardous situation which, if not avoided, will result in serious injury or death.</p>
	<p> WARNING</p> <p>WARNING indicates a hazardous situation which, if not avoided, could result in serious injury or death.</p>
	<p> CAUTION</p> <p>CAUTION indicates a hazardous situation which, if not avoided, could result in minor or moderate injury.</p>
	<p>NOTICE</p> <p>Notice about a harmful situation, possible consequences: the product itself or surrounding objects could be damaged.</p>

2. Safety Notices

2.1 Proper and Intended Usage



The MEGAMAT MPR drive is meant to be installed in an end product.



- It provides motor adjustment capabilities for movable furniture. It should be used in conjunction with suitable fittings and mechanics.



	 CAUTION
	This drive should only be used for the applications described above. Any other form of usage is not permitted and can lead to accidents or destruction of the unit. Such non-approved applications will lead immediately to the expiration of all guarantee and warranty claims on the part of the end-product manufacturer against the manufacturer.

Improper usage

Be sure to follow the notices below concerning improper usage. You should include them in your product manual in order to inform the users of your end product.

	 WARNING
	The MEGAMAT MPR drive should not be used: <ul style="list-style-type: none"> • in any environment where combustible or explosive gases or vapours (e.g., anaesthesiology) may be present, • in a moist environment, • outdoors, • in any application that will be cleaned with an automated washing system

	 CAUTION
	The MEGAMAT MPR drive may not be operated: <ul style="list-style-type: none"> • by small children, • by frail or infirm persons without supervision, or • in the proximity of small children.

	 CAUTION
	You should only use spare parts which have been manufactured or approved by DewertOkin. Only these parts will guarantee a sufficient level of safety.

2.2 Safety notices within the installation instruction and the operating instructions for the entire machine

The manufacturer of the end product is only permitted to operate the MEGAMAT MPR drive (by itself an incomplete machine)

- when the end product (for which the MEGAMAT MPR drive is intended) is in compliance with all protective measures specified in the Machinery Directive 2006/42/EC, and
- when the manufacturer expressly declares the compliance of the end product.

The manufacturer of the end product must create a manual for the users of that product. The safety notices in the end-product manual must be written based on the end product's risk assessment.

2.3 Selection and qualification of personnel

This drive should only be installed into the end product by someone who has completed training in electronic motor assembly or has equivalent qualifications.

You should only install this drive when you are qualified to do so. Otherwise, a properly qualified person should be found for this task.

2.4 Notice on safety during operations

Basic safety rules must be followed in order to ensure that the end product can be continually operated in a safe manner. These rules must be observed while using the end product and while installing the drive.

These rules and safety measures can be categorized as follows:

- Construction measures before the installation (refer to the "Ensuring operational reliability during installation" section in the "Installation" Chapter).
- Safety fundamentals during the drive installation and during cable and wire routing (refer to the "Safety notices to observe during installation" section in the "Installation" Chapter).
- Using the drive in intermittent duty (refer to the "General notices" section in the "Operating Notes" Chapter).
- Basic safety rules during operation (refer to the "Operating Notes" Chapter).
- The creation of a manual for the end product which contains these and other safety rules.

Creating a user's manual

The manufacturer of the end product must create a manual for the users of that product. The safety notices in the end-product manual must be written based on the end product's risk assessment.

2.5 Product identification

2.5.1 Ratings plate (type label)

A ratings plate on each drive specifies the exact name and serial number of the drive. It also states the technical specifications valid for that particular drive. The following illustration shows where the specifications are located on the drive's ratings plate.

- ▶ The ratings plate shown is an example; the specifications for your drive may differ from this illustration.

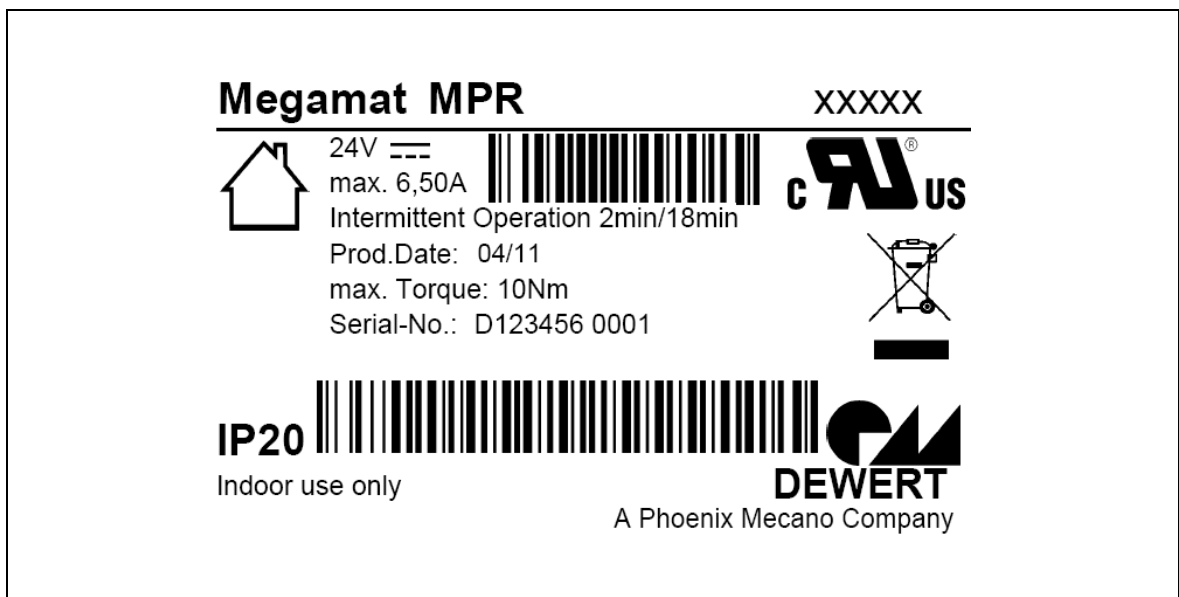



Figure 2 Ratings plate example

Megamat MPR	Model name
xxxxxx	Article number
24V	Input voltage
Max. 6.50A	Current consumption
Intermittent Operation 2min/18min	Intermittent operations: 2 minutes / 18 minutes
Prod.date	Calendar week / year
Max. torque	Torque
Serial No.	Serial number for your drive
IP20	Protection degree
	Use in dry rooms only!
	Follow all special disposal instructions!

2.5.2 Safety symbol

The symbol below is attached to the drive and has the following meaning:



This symbol indicates that the unit should only be opened by qualified specialists!

3. Possible Combinations

The MEGAMAT MPR single drive can be combined for use with other single drives, double drives or control units. The following basic combinations are possible:

- a MEGAMAT MPR with a handset,
- a MEGAMAT MPR in combination with other drives with an additional control unit or double drive.

Systems can be customized by combining drives with the handset and control units as needed. The system components must be connected in a specific order. Make sure that you switch off the electricity before connecting any components (connect while in a voltage-free state).

DewertOkin has separate system instruction manuals containing all information and instructions needed for these systems.

- ▶ Only a DewertOkin device should be used to control the drive since they have already been verified to work together.
- ▶ A control unit or a double drive is needed to operate the MEGAMAT MPR single drive.

4. Description

The MEGAMAT MPR drive is an electric motor-driven unit which provides rotary motion needed for carrying out adjustment functions in the end product. The adjustment functions are controlled by an additional control unit or a double drive to which a DewertOkin handset is connected.

The different drive models vary according to the

- power of the drive.
- ▶ We reserve the right to make unannounced technical changes in the course of our continual product improvement process!
- ▶ The "Possible Combinations" Chapter describes the different possible combinations of drives and handsets/hand-held remote controls. You can also ask your supplier or dealer for additional information.

4.1 Components

The main components of the MEGAMAT MPR drive are the electric motor and the receptacle for the shaft adapter. The shaft adapter transmits the rotation. The drive is ready to be attached to the end product.

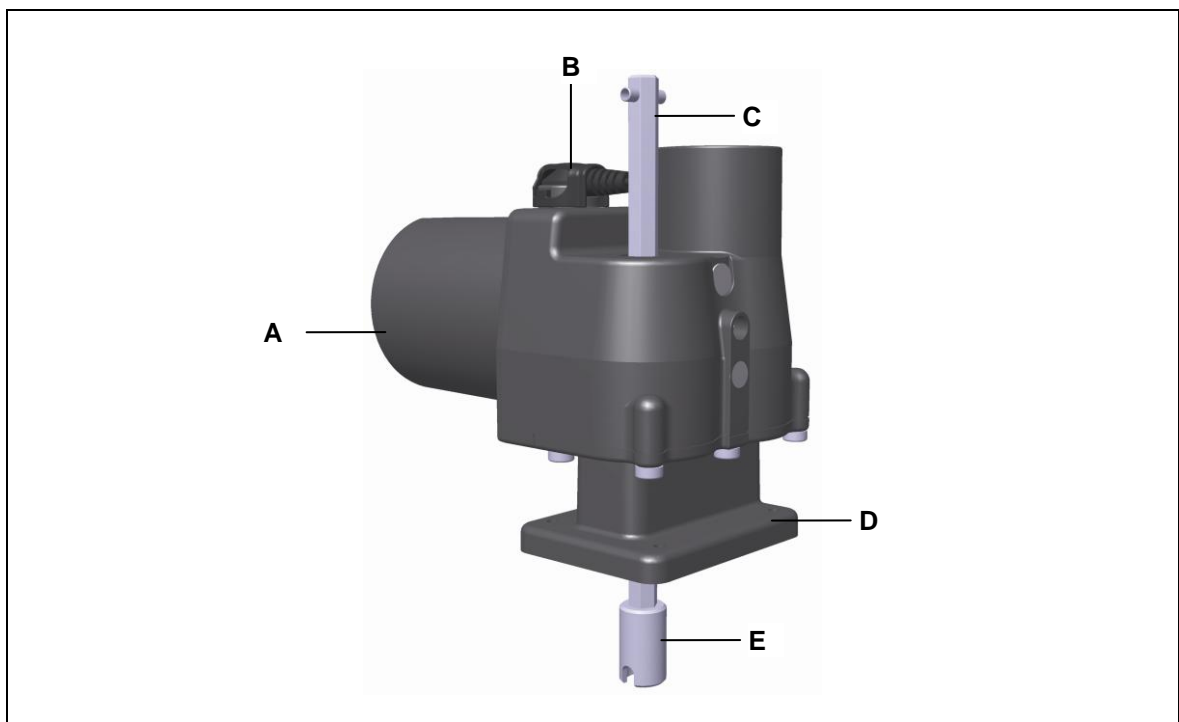

Figure 3 Main components of the MEGAMAT MPR drive

- | | |
|--|--|
| A Motor housing | B Electrical connection |
| C Shaft adapter | D Adapter plate for mounting to the end product |
| E Forked end of the shaft adapter | |

5. Technical Specifications

Rated voltage	24 V DC
Power consumption at max. torque	Max. 6.50 A, depending on version (refer to the drive's rating plate)
Permissible torque	Max. 10 Nm, depending on version (refer to the ratings plate on the drive)
Mode of operation ¹ under max. rated load	Intermittent duty: 2 min./18 min.
Protection classification	III
Noise level	≤ 65 dB(A)
Drive type	Single drive
Max Speed ²	120 min ⁻¹
Torque transmission	Shaft adapter AF10, according to DIN EN 10278
Protection degree	IP20
Colours	Grey / black
Dimensions and weight	
Length x width x height	178 mm x 110 mm x 149 mm (not including shaft adapter)
Weight	Approx. 2.5 kg, depending on version
Ambient conditions for operation, storage and transport	
Ambient room temperature for storage and transport	from -20 °C to +50 °C from -4 °F to +122 °F
Ambient room temperature for operation	from +10 °C to +40 °C from +50 °F to +104 °F
Relative humidity	from 30% to 75%
Air pressure	from 800 hPa to 1060 hPa
Altitude	< 2000 m

¹⁾ Mode of operation: intermittent duty = 2 min./18 min. This means that after the unit is operated with its rated load for up to two minutes it must then be paused for 18 minutes. The system can malfunction if this pause is not observed!

²⁾ Depending on the drive configuration: at constant 24V and under no load.

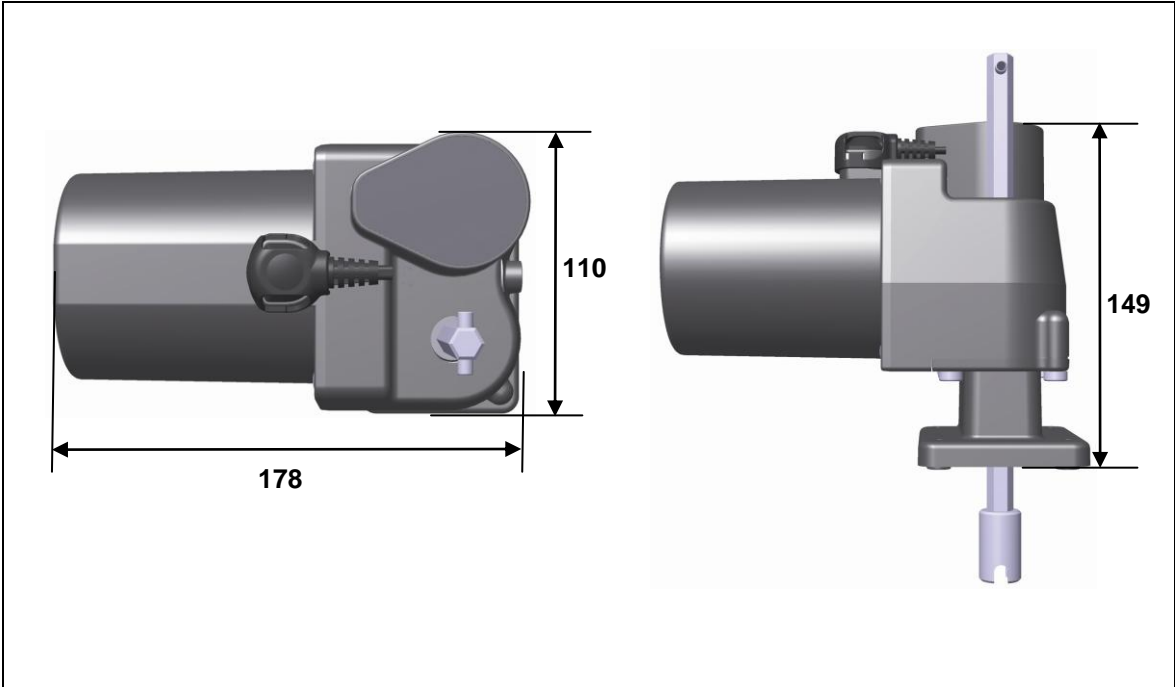

Figure 4 Dimensions of MEGAMAT MPR drive (in mm)

6. Installation



6.1 Safety notices to observe during installation

Basic safety rules must be followed in order to ensure that the end product can be continually operated in a safe manner. These rules must be observed while using the end product and while installing the drive.

6.1.1 Ensuring operational reliability during installation

The safety and reliability of the end product containing the DewertOkin drive can be ensured by using the proper construction methods described below.

Avoiding fatigue fractures



	 CAUTION
	<p>Drives that are incorrectly installed can undergo fatigue fractures which then create a risk of injury.</p> <ul style="list-style-type: none"> • Install the drive in the end product so that it is properly aligned. This will help prevent shear stress. • Do not position the drive at a slanted angle when installing it in the end product. A slanted angle between the intended direction of movement of the end product and the drive's direction will create shear stress and could lead to a fatigue fracture. • Be sure to install the drive so that it can always move freely in all operative states. • The manufacturer of the end product is responsible for installing a limit cut-off.

Avoiding an overrun with the end product

Your end product should contain mechanical end stops. These will limit the drive movement and significantly increase operational safety. DewertOkin recommends that you build such mechanical end stops into your end product.

If, for technical or cost reasons, you choose not to use end stops, then we strongly recommend the use of an additional, external safety limit switch whenever the DewertOkin drive is being used for at-risk functions.

Avoiding a pinching hazard

 CAUTION
 Installation methods for ensuring passive safety: Install the MEGAMAT MPR drive so that none of the positions where shear and pinch hazards exist are accessible externally.

When preparing safety notices for the operator, be sure that your operating instructions inform the user of these points.

6.2 Installation procedure

6.2.1 An example installation

Before installing the drive, make sure that you are observing all of the safety notices found in the "Safety notices to observe during installation" section.

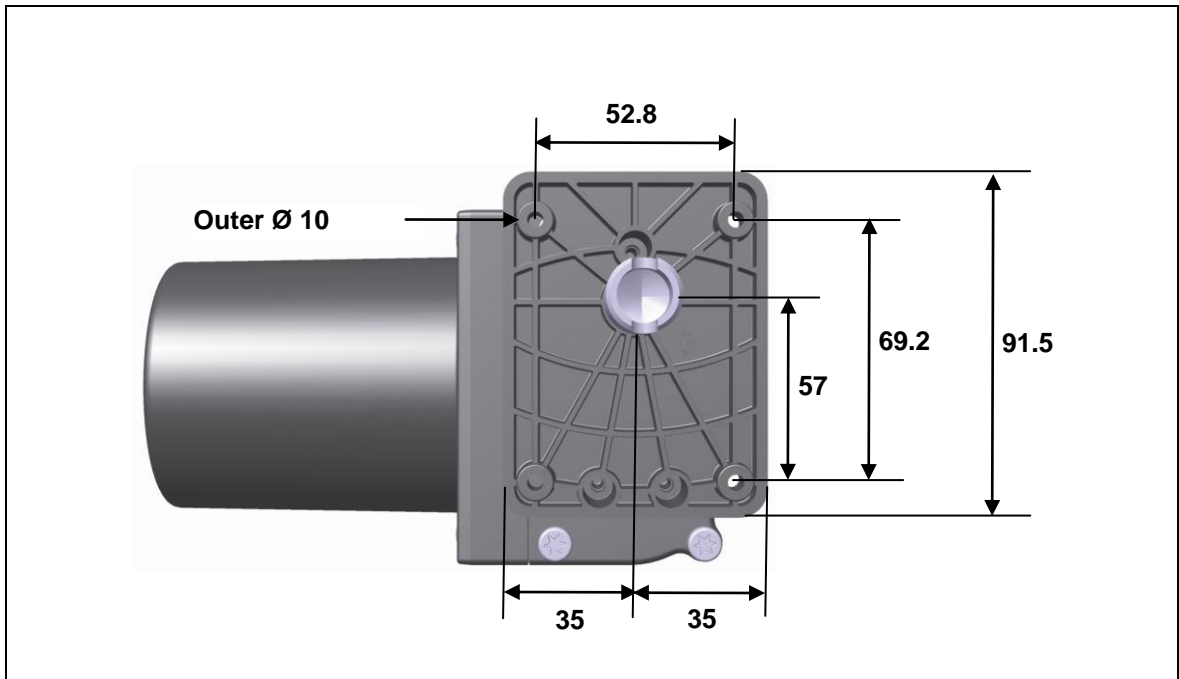

Figure 5 Mounting dimensions on the adapter plate of the MEGAMAT MPR (in mm)

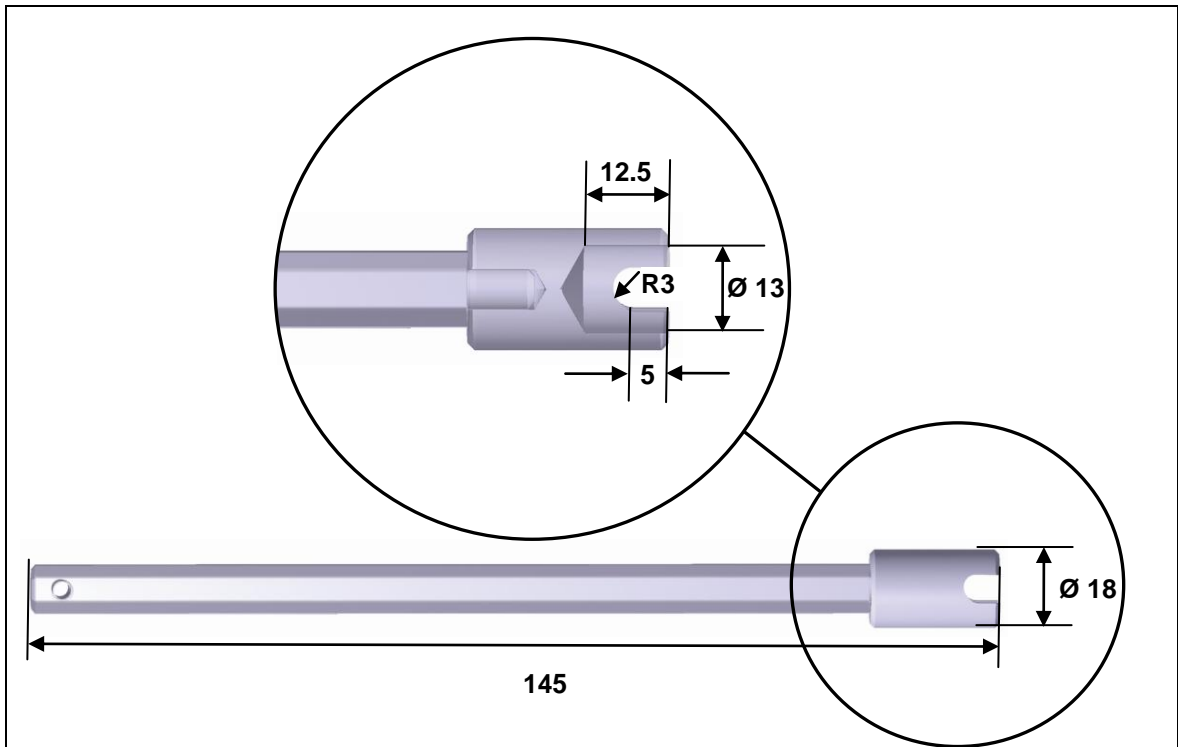

Figure 6 Dimensions of shaft adapter (in mm)

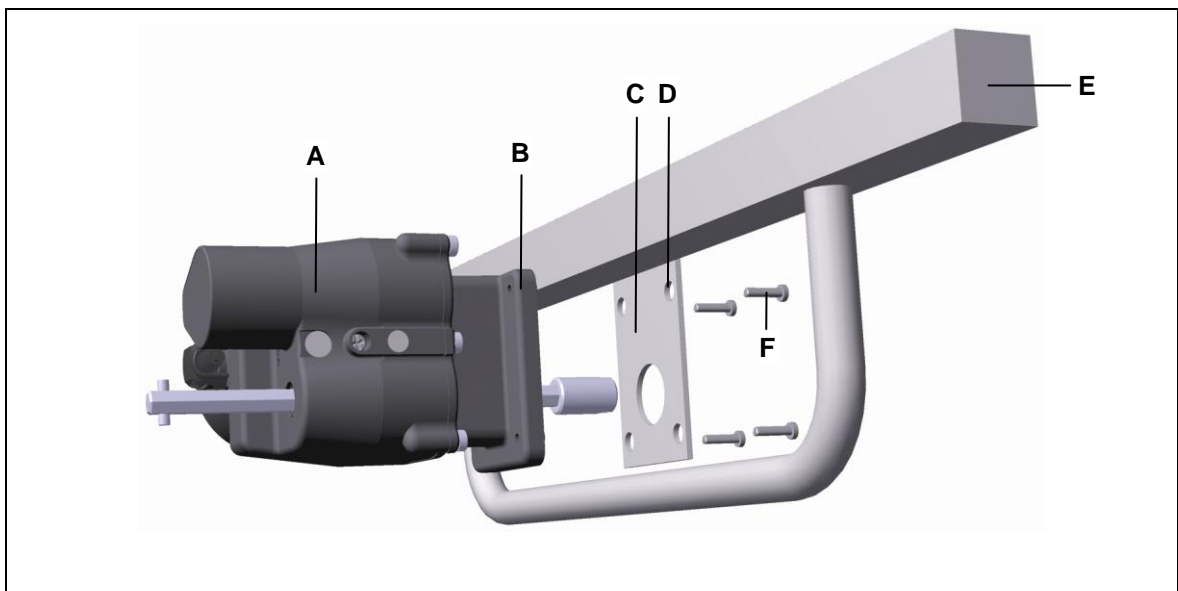



Figure 7 Installing the drive (example)

- | | |
|---|--|
| A MEGAMAT MPR drive | B Adapter plate for the drive |
| C Mounting plate for the end product (thickness min. 2 mm) | D Receptacle holes in the mounting plate (Ø min. 10.2 mm) |
| E End product (example) | F Screws (self tapping, type M05x20 to DIN 7500) |

	CAUTION
The mains power cable should be unplugged during the installation.	

► Certain details may change as a result of technical changes.

- 1 Prepare a suitable mounting plate (as shown by C in Figure 7, with min. thickness of 2 mm) for attaching the MEGAMAT MPR drive to the end product (E). Figure 5 shows the dimensions of the adapter plate (B) of the drive. Note the intended direction of rotation (as shown in Figure 8) in accordance with the proposed alignment of the drive.

	NOTICE
Mount the MEGAMAT MPR drive so that the drive will be loaded in the preferred direction (for example, lifting a table when operating the MEGAMAT MPR in the preferred direction of rotation).	

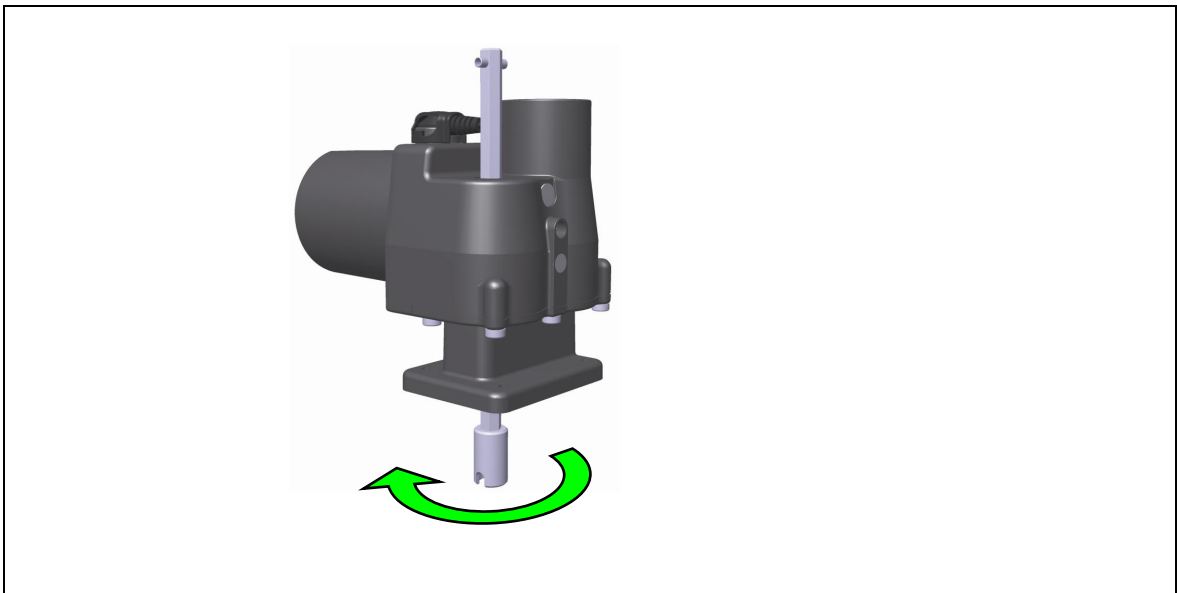



Figure 8 Intended rotation direction of the MEGAMAT MPR

- 2 Move your product into a position where it is supporting no load.
- 3 Mount the adapter plate (B) of the drive in the proper direction using four screws (self tapping, M 5 x 20) to the mounting plate (C).
- 4 Attach the moveable part of the end product to the forked end of the shaft adapter.
- 5 Now connect the drive to the control unit or double drive.

Electrical connection

	 CAUTION Electrical components should be connected or disconnected only when the power supply cord for the control unit is unplugged.
---	--



Routing the electrical cables

When routing the cables, be sure that:

- the cables cannot get jammed,
- no mechanical load (such as pulling, pushing or bending) will be put on the cables, and
- the cables cannot be damaged in any way.



Fasten all cables (especially the mains cable) to the end product using sufficient strain relief and kink prevention methods. Be sure that the design of the end product prevents the mains cable from coming into contact with the floor during transport.

6.2.2 Dismantling

	 CAUTION
	<p>Work on electrical components should be conducted only when the mains power connection for the control unit is unplugged.</p>

► Certain details may change as a result of technical changes.

- 1 Move your product into a position where it is supporting no load.

	 CAUTION
	<p>Be sure to carry out work on the drive in a position so that no loads are bearing on it. Only in this way can you be sure to avoid any risks of crushing or injury.</p>



- 2 Pull out the control unit's mains power plug!
- 3 If multiple drives are connected electrically they should be disconnected from each other.
- 4 Disconnect the drive from the control unit or double drive.

	NOTICE
	<p>Be sure to support the drive's weight while you are loosening the screws.</p>

- 5 Remove the screws from the adapter plate.
- 6 Pull out the drive from the end product.

7. Operating Notes

The factual information contained within may be used when you are creating the end-product manual. The installation instructions do not contain all information required for the safe operation of the end product. They only describe the installation and operation of the drive as a partially assembled piece of machinery.

	 CAUTION
	When creating the operating instructions, remember that the installation instructions are intended for qualified specialists and are not for typical users of the end product.

7.1 General notices



- ▶ Only a DewertOkin device should be used to control the drive since they have already been verified to work together.

Power-on time / intermittent operations



The MEGAMAT MPR drive has been designed for intermittent operations. Intermittent operation is an operational mode where the drive must pause after a specified maximum period of operation (power-on time). This protects the drive from overheating. In an extreme case, overheating can lead to a malfunction.

- ▶ The ratings plate on the drive specifies the maximum power-on time and the required pause intervals.

Avoiding electrical risks



	 WARNING
	Be sure that all live (current-carrying) parts of the drive system and power supply cannot be touched. In particular, be sure that unused power and control unit connections are covered adequately.

Shutting off the drive

	 CAUTION
	In order to shut off the drive, unplug the mains power plug on the control unit or the double drive. The power plug (of the control unit or double drive) must always be accessible during operations so that emergency shut-off is possible.



Avoiding cable damage

Be sure that your operating instructions inform the user about the possible cable risks.

	 CAUTION
	The cables (particularly the connecting cable) should not be run over. In order to prevent injuries or drive damage, no mechanical strain should be placed on the cables.

8. Troubleshooting

This chapter describes troubleshooting methods for fixing problems. If you experience an error that is not listed in this table, please contact your supplier.

	 CAUTION
	<p>Only qualified specialists who have received electrician training should carry out troubleshooting and repairs.</p>

Problem	Possible cause	Solution
The handset or drive system is not functioning.	There is no mains supply voltage.	Connect the mains power.
	The hand switch or drive system is defective.	Please contact your supplier or sales agent.
The drive is suddenly not capable of movement.	Possibly the thermal circuit breaker on the transformer has been triggered or is defective.	The drive system should be allowed to pause for 20 to 30 minutes.
	The thermal fuse on the transformer may have been triggered or may be defective.	Please contact your supplier or sales agent.
	The unit's fuse may have been triggered or may be broken.	Please contact your supplier or sales agent.
	There is no mains supply voltage.	Connect the mains power.
	A lead-in connection has been interrupted (mains power, hand switch or auxiliary drive).	Check the cables and reinsert them, if required.

9. Maintenance

- ▶ You should only use spare parts which have been manufactured or approved by DewertOkin. Only these parts will guarantee a sufficient level of safety.

9.1 Maintenance

Type of check	Explanation	Time interval
Check the function and safety of the electrical system.	A qualified electrician should carry out this inspection. (Refer to the "Electrical connection" section in the "Installation" chapter.)	Periodic inspections can be carried out at intervals based on the risk assessment which you conduct for your end product.
Look over the housing periodically for any signs of damage.	Check the housing for breaks or cracks. The IP degree of protection will be impaired by any breakage or cracks.	At least every six months.
Look over the plug-in connections and electrical access points for signs of damage.	Check that all electrical cables and connections are firmly seated and correctly positioned.	At least every six months.
Look over the cables for any signs of damage.	Check the connecting cables for pinching or shearing. Also check the strain relief and kink protections mechanisms, in particular after any mechanical load.	At least every six months.

9.2 Cleaning and care

The MEGAMAT MPR drive was designed so that it would be easy to clean. The smooth surfaces can be conveniently cleaned.

	NOTICE
	Never clean the drive in an automated washing system or with a high-pressure cleaner. Do not allow fluids to penetrate the drive. Damage to the system could result.

- 1 Always disconnect the mains power plug of the control unit or double drive (and the battery cord if present) before you start to clean the unit!
- 2 Clean the MEGAMAT MPR drive using a moist cloth
- 3 Be sure that you do not damage the drive's connecting cable.

	NOTICE
	Do not use a cleanser that contains benzene, alcohol or similar solvents.

10. Disposal

The MEGAMAT MPR drive consists of electronic components, cables and metal and plastic parts. You should observe all corresponding national and regional environmental regulations when disposing of the MEGAMAT MPR drive.

The disposal of the end product is regulated in Germany by Elektro-G, internationally by the EU Directive 2012/19/EC (WEEE), or by any applicable national laws and regulations.



The MEGAMAT MPR drive should not be disposed of with normal household waste!

Einbauerklärung

nach Anhang II der EU-Maschinenrichtlinie
2006/42/EG

Der Hersteller

Declaration of Incorporation

*According to Appendix II of the EU Machinery
Directive 2006/42/EC*

The manufacturer:

DewertOkin GmbH
Weststraße 1
32278 Kirchlengern
Deutschland - Germany

erklärt hiermit, dass nachstehend beschriebene
unvollständigen Maschinen

*declares that the incomplete machines described
below*

MEGAMAT MPR

die folgenden grundlegenden Anforderungen der
Richtlinie Maschinen (2006/42/EG) erfüllt:

*complies with the following basic requirements of the
Machinery Directive (2006/42/EC):*

Abschnitt:

Sections:

1.1.3; 1.3.3; 1.3.4; 1.3.7; 1.5.1; 1.5.2; 1.5.5; 1.5.6; 1.5.7; 1.5.8; 1.5.9; 1.5.10; 1.5.13

Die unvollständige Maschine darf erst dann in Be-
trieb genommen werden, wenn festgestellt wurde,
dass die Maschine, in die die unvollständige Ma-
schine eingebaut werden soll, den Bestimmungen
der Richtlinie Maschinen (2006/42/EG) entspricht.

*You may only operate this incomplete machine after
you have confirmed that the end product (into which
this machine will be installed) complies with the
Machinery Directive 2006/42/EC.*

Der Hersteller verpflichtet sich, die speziellen Unter-
lagen zur unvollständigen Maschine einzelstaatli-
chen Stellen auf begründetes Verlangen elektronisch
zu übermitteln. Die zur Maschine gehörenden
speziellen technischen Unterlagen nach Anhang VII
Teil B wurden erstellt.

*On reasonable request, the manufacturer is obliged
to send the special documentation accompanying the
partially completed machinery in electronic form to
the appropriate national institution. The special
technical documents corresponding to the machine
have been created according to Appendix VII, part B.*

Für die Zusammenstellung der technischen Unter-
lagen ist bevollmächtigt: DewertOkin GmbH
Weststraße 1
32278 Kirchlengern
Tel.: 05223 979-0
Deutschland - Germany

*For preparation of the technical documentation is
authorized: DewertOkin GmbH
Weststraße 1
32278 Kirchlengern
Tel.: 05223 979-0
Deutschland - Germany*

Kirchlengern, Germany 25 November 2019



Dr.-Ing. Josef G. Groß
Geschäftsführer / Managing Director

EG-Konformitätserklärung

Nach Anhang IV der EMV-Richtlinie 2014/30/EU

Nach Anhang IV der EU-Niederspannungsrichtlinie 2014/35/EU

Nach Anhang VI der RoHS-Richtlinie 2011/65/EU (inkl. Delegierte Richtlinie (EU) 2015/863)

Der Hersteller

EU Declaration of Conformity

In compliance with Appendix IV of the EMC-Directive 2014/30/EU

In compliance with Appendix IV of the LVD-Directive 2014/35/EU

In compliance with Appendix VI of the EU RoHS Directive 2011/65/EU (incl. Commission delegated Directive (EU) 2015/863)

The manufacturer

DewertOkin GmbH
Weststraße 1
32278 Kirchlengern
Deutschland - Germany

erklärt hiermit, dass das Produkt

declares that the following product

MEGAMAT MPR

mit DewertOkin-Steuerung / *with DewertOkin Control unit*

die Anforderungen folgender EG-Richtlinien erfüllt:

meets the requirements of the following EU directives:

Richtlinie über elektromagnetische Verträglichkeit 2014/30/EU

Electromagnetic Compatibility Directive 2014/30/EU

Niederspannungsrichtlinie 2014/35/EU

Low Voltage Directive 2014/35/EU

DELEGIERTE RICHTLINIE (EU) 2015/863 DER KOMMISSION vom 31. März 2015 zur Änderung von Anhang II der Richtlinie 2011/65/EU des Europäischen Parlaments und des Rates hinsichtlich der Liste der Stoffe, die Beschränkungen unterliegen.

COMMISSION DELEGATED DIRECTIVE (EU) 2015/863 of 31 March 2015 amending Annex II to Directive 2011/65/EU of the European Parliament and of the Council as regards the list of restricted substances.

Angewendete Normen

Applied standards:

- EN 60335-1:2012/A11:2014
- EN 55014-1:2006/A1:2009/A2:2011
- EN 55014-2:1997/A1:2001/A2:2008
- EN 61000-3-2:2014
- EN 61000-3-3:2013
- EN 62233:2008

Konstruktive Änderungen, die Auswirkungen auf die in der Montageanleitung angegebenen technischen Daten und den bestimmungsgemäßen Gebrauch haben, das Produkt also wesentlich verändern, machen diese Konformitätserklärung ungültig!

This declaration of conformity is no longer valid if constructional changes are made which significantly change the drive system (i.e., which influence the technical specifications found in the instructions or the intended use)!



Kirchlengern, Germany 25 November 2019

Dr.-Ing. Josef G. Groß
Geschäftsführer / Managing Director

Additional information

MEGAMAT MPR single drive

In accordance with EN 60601-1:1990 +A1:1993 +A2:1995, "Electrical medicinal devices" (for those versions with a degree of protection at IPX4 or above), the following standards are used:

EN 60601-1, main section 2	Environmental conditions
EN 60601-1, main section 3	Electrical shock protection
EN 60601-1, section 21	Mechanical attachment
EN 60601-1, main section 7	Overheating protection
EN 60601-1, main section 9	Improper operations and malfunctions
EN 60601-1, main section 10	Structural requirements
EN 60601-1, section 56.8	Power supply indicator is, however, not present
EN 60601-1, section 36	Electromagnetic compatibility
EN 60601-2	Electromagnetic compatibility

According to IEC 60601-1, EN 60601-1, third edition, and IEC 60601-2-52, EN 60601-2-52, Medical electrical equipment - in versions with a protection degree of IPX4 or higher, the following standards are used:

IEC/EN 60601-1, section 4	General requirements
IEC/EN 60601-1, section 6	Classification
IEC/EN 60601-1, section 7.1	Labelling – general
IEC/EN 60601-1, section 7.2	Labelling – inscriptions
IEC/EN 60601-1, section 8	Protection against electrical danger
IEC/EN 60601-1, section 11.1	Overheating protection
IEC/EN 60601-1, section 11.2	Fire prevention
IEC/EN 60601-1, section 11.3	Design requirements for fire-resistant housing
IEC/EN 60601-1, section 13	Dangerous situations and error conditions
IEC/EN 60601-1, section 16.6	Leakage current
IEC/EN 60601-1, section 17	Electromagnetic compatibility
IEC/EN 60601-2-52, section 201.11.6.5.101	Protection against ingress of water (for protection degree of at least IPX4)
IEC/EN 60601-2-52, section 201.9.8.3.2	Static load

DewertOkin GmbH
Weststraße 1
32278 Kirchlengern, Germany
Tel: +49 (0)5223/979-0
Fax: +49 (0)5223/75182
<http://www.dewertokin.de>
Info@dewertokin.de

ID-Nr.: 68013