



IPROXX /AC /FLEX /SAT Control System

Installation Instructions

(Translation of the original installation instructions)

Foreword

Disclaimer and exclusion of liability

DewertOkin is not responsible for damage resulting from:

- failure to observe these instructions,
- changes made to this product which have not been approved by DewertOkin, or
- the use of replacement parts which have not been approved or manufactured by DewertOkin.

Contact address

DewertOkin GmbH
Weststraße 1
32278 Kirchlegern
Germany
Tel: +49 (0)5223/979-0
Fax: +49 (0)5223/75182
<http://www.dewertokin.de>
Info@dewertokin.de

Creation of a complete operating instruction manual for the entire end product

These instructions are only intended to be used by the end-product manufacturer. They should not be given to the operator of the end product. The factual information contained within may be used as a basis when creating the end-product manual.

The warning and danger notices are best suited for use in the end-product's manual. However it is not sufficient to simply follow these notices. You should also carry out an internal risk assessment for your end product. This can then be used as the basis for the safety notices in your manual.

Usage in medical products

The IPROXX /AC /FLEX /SAT control system is not a medical product. If used in a medical end product, you (the end manufacturer) are obliged to ensure compliance with EC directives and to ensure that other pertinent medical product regulations are maintained.

Table of Contents

Foreword	2
Disclaimer and exclusion of liability	2
Contact address	2
Creation of a complete operating instruction manual for the entire end product	2
Usage in medical products	2
Table of Contents	3
1. General	5
1.1 About these installation instructions	5
1.2 Conventions used	5
2. Safety Notices	6
2.1 Proper and intended usage	6
2.2 Selection and qualification of personnel	7
2.3 Notice on safety during operations	7
2.4 Components labeling	8
3. Description of System	10
3.1 Version: MEDITOUCH	10
3.2 Version: Handset	11
3.3 System components	12
4. Technical Specifications	15
4.1 CU155 MEDITOUCH and IPROXX /AC /FLEX /SAT	15
5. Installation	18
5.1 Safety notices to observe during installation	18
5.2 Installation procedure	18
6. Notices for Operation	25
6.1 General notices	25
6.2 Starting the MEDITOUCH system for the first time	26
7. Troubleshooting	27
8. Maintenance	28
8.1 Maintenance	28
8.2 Cleaning and care	29



9.	Disposal	29
9.1	Packaging material	29
9.2	Control system components	29
	Additional information	30
	EU Declaration of Conformity	31

1. General

1.1 About these installation instructions

These installation instructions must be followed closely in order to install this drive successfully and safely in the end product. These instructions are not an operating manual for the end product.

These instructions will help you to minimize danger, repair costs and down times. They will also help you to increase the reliability and lifespan of the end product.

 CAUTION
 <p>The notices in these instructions must be followed! Following the guidelines during installation and connection procedures will help to minimize:</p> <ul style="list-style-type: none"> • the risk of accident and injury, and • damage to the control system of the end product.

These installation instructions have been written with due care and attention. However, unless otherwise required by law, we do not guarantee that the data, images and drawings are accurate or complete nor do we accept liability for their contents.



- ▶ We reserve the right to make unannounced technical changes in the course of our continual product improvement process!



1.2 Conventions used

Notices which do not relate to safety are indicated in these instructions with a triangle:

- ▶ Triangular notice symbol

Explanations of warning notices

 CAUTION
 <p>CAUTION indicates a hazardous situation which, if not avoided, could result in minor or moderate injury.</p>



 WARNING
 <p>NOTICE is used to address practices which are not related to personal injury but may result in damage to the product or surroundings.</p>

2. Safety Notices

2.1 Proper and intended usage

The IPROXX /AC /FLEX /SAT control system is intended to be installed in an end product. It can be used as follows:

- for operating DewertOkin drive systems and for controlling (unlocking and releasing) the adjustment functions (can be used, for example, in beds).
- It can be used for care purposes (CARE).
- It can be used in a hospital (HOSP).

 CAUTION
 <p>The control system should only be used for the applications described above. Any other application is not permitted and can lead to accidents or damage to the unit. Such non-approved applications will lead immediately to the expiration of all guarantee and warranty claims on the part of the end-product manufacturer against DewertOkin.</p>

The IPROXX /AC /FLEX /SAT control system can be used with the DewertOkin control units/double drives from the following product lines: CARE / CARE L / HOSP or FURNIBUS.

Improper usage

Be sure to follow the notices below concerning improper usage. You should include them in your product manual in order to inform the users of your end product.

The IPROXX /AC /FLEX /SAT control system should not be used:

- in any environment where combustible or explosive gases or vapors (e.g., anaesthesiology) may be present,
- in any application that will be cleaned with an automated washing system,
- in a moist environment,
- outdoors.

The IPROXX /AC /FLEX /SAT control system may not be operated:

- by small children,
- by frail or infirmed persons without supervision, or
- in the proximity of small children.

The IPROXX /AC /FLEX /SAT control system can be used by children aged 8 years and above, as well as persons with reduced physical, sensory or mental capabilities or with lack of experience and knowledge when they are supervised or have been instructed in the safe use of the equipment and understand the dangers which can result. Children may not play with the device. Cleaning and user maintenance may not be carried out by children without supervision.

- ◆ You should only use spare parts which have been manufactured or approved by DewertOkin. Only these parts will guarantee a sufficient level of safety.

2.2 Selection and qualification of personnel

This control system should only be installed into the end product by someone who has completed training in electronic motor assembly or has equivalent qualifications.

You should only install this control system when you are qualified to do so. Otherwise, a properly qualified person should be found for this task.

2.3 Notice on safety during operations

Basic safety rules must be followed in order to ensure that the end product can be continually operated in a safe manner. These rules must be observed while using the end product and while installing the control system.

These rules and safety measures can be categorized as follows:

- Safety fundamentals during the installation of the control system and during cable and wire routing (refer to the "Safety notices to observe during installation" section in the "Installation" Chapter).
- Basic safety rules during operation (refer to the "Notices for Operation" Chapter).
- The creation of a manual for the end product which contains these and other safety rules.

Creating a user's manual

The manufacturer of the end product must create a manual for the users of that product. The safety notices in the end-product manual must be written based on the end product's risk assessment.

2.4 Components labeling

2.4.1 Ratings plate (type label)

The control system consists of a number of components.

A ratings plate on each component specifies the exact name and serial number of the component. It also states the technical specifications for that particular component. The following illustrations show the location of the ratings plate specifications on the components which make up the control system.

- ▶ The ratings plate shown is an example; the specifications for your component may differ from this illustration.

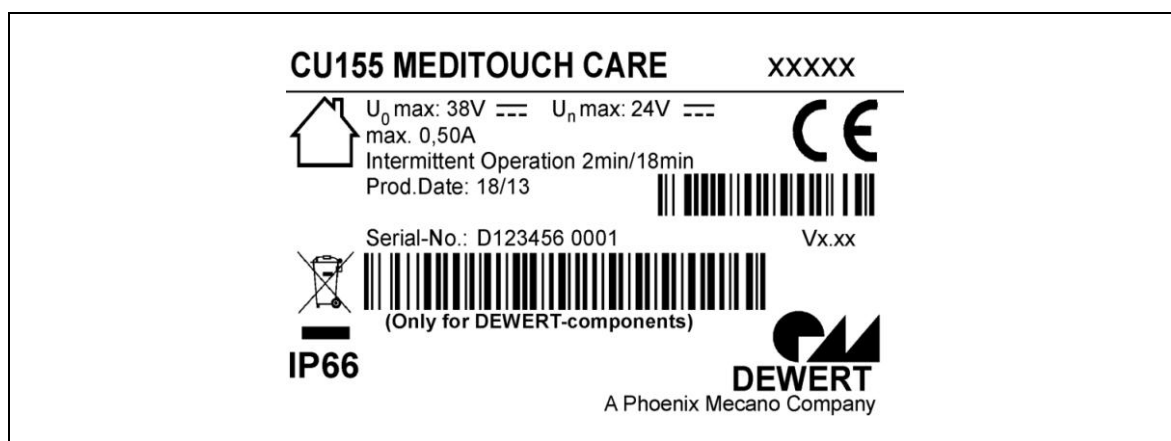





Figure 1 Ratings plate for the CU155 MEDITOUCH CARE (example)

CU155 MEDITOUCH CARE	Model name
XXXXXX	Article number
U ₀ max. 38V	No-load voltage
U _n max. 24V	Rated voltage
max. 0,50A	Current consumption
Intermittent Operation 2min/18min	Intermittent operations: 2 minutes / 18 minutes
Prod. Date	Calendar week / year
Serial-No.	Serial number
Vx.xx	Software version
IP66	Protection category
	Use in dry rooms only!
	Follow all special disposal instructions!
	Conformity mark

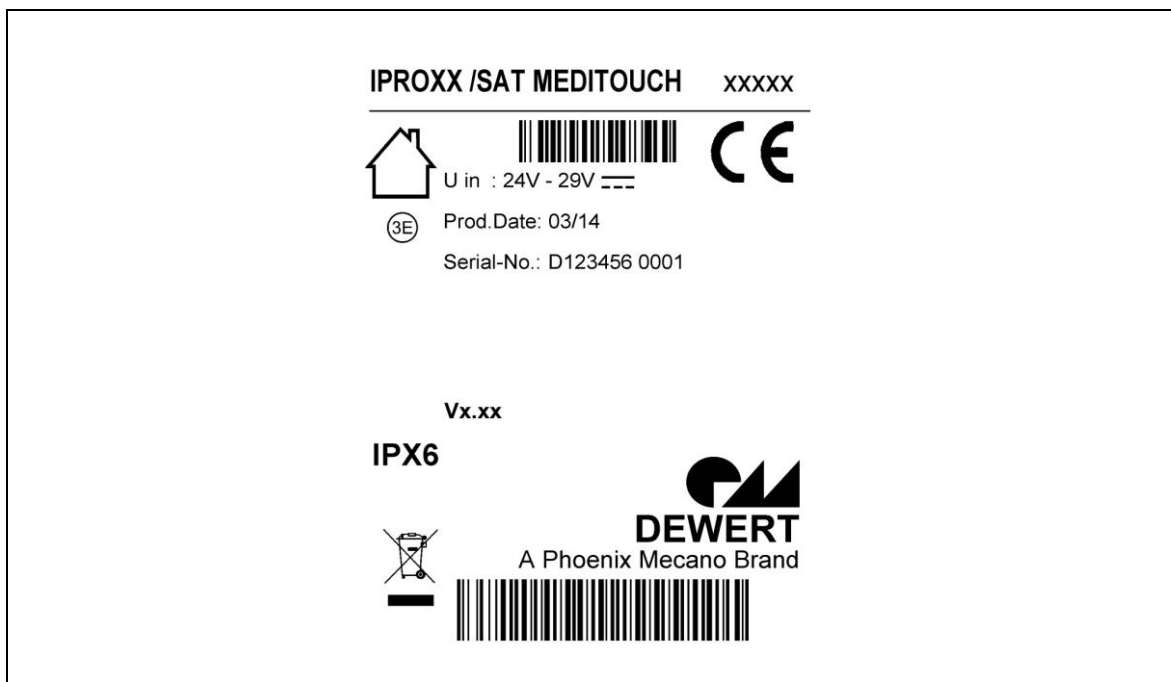





Figure 2 Ratings plate for the IPROXX /SAT MEDITOUCH (example)

IPROXX /SAT MEDITOUCH	Model name
xxxxx	Artikelnummer
U in: 24V – 29V	Input voltage
Prod.Date	Calendar week / year
Serial-No.	Serial number
Vx.xx	Software version
IPX6	Protection category
	Use in dry rooms only!
	Follow all special disposal instructions!
	Conformity mark
	Identification: see additional information

3. Description of System

The IPROXX /AC /FLEX /SAT control system is used to adjust and control the movable parts of the end product (e.g., hospital and patient beds).

The IPROXX / AC control system features a handset hook on the back.

The IPROXX / FLEX / SAT control system features an infinitely adjustable flexible handset holder.

3.1 Version: MEDITOUCH

The control system in the version MEDITOUCH consists of a number of distinct components. In order to use the system, the following components are required: a control unit (MCL or SG(AG)300), a CU155 MEDITOUCH and max. four IPROXX /AC, IPROXX /FLEX or IPROXX /SAT (version: MEDITOUCH) control systems.

Additional optional components can also be connected to the control system, such as Floorlight, a IPROXX /SAT /FLEX, a handset, or a foot switch.

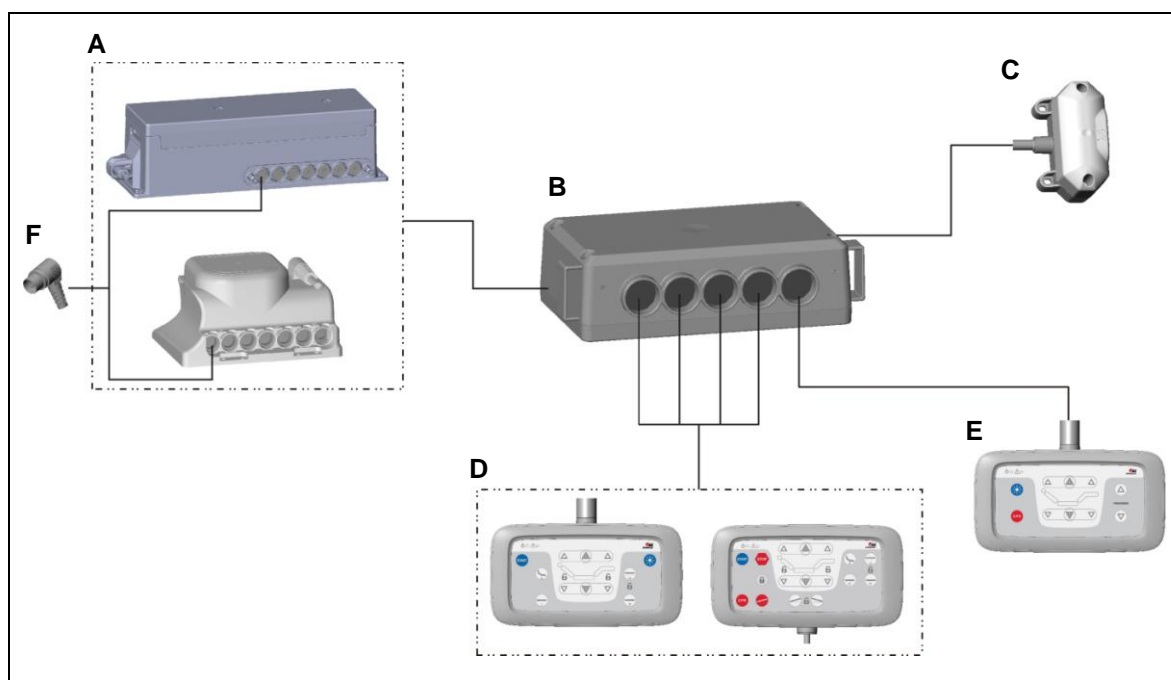

Figure 3 The MEDITOUCH control system – a sample configuration

- | | |
|--|---|
| <p>A DewertOkin control unit
(Optional: SG(AG) 300 series or MCL)</p> <p>C Optional: UBB-Floorlight, or a floating voltage-free) contact (can be used contacting the nurse)</p> <p>E Optional additional control system (IPROXX /AC, IPROXX /SAT, IPROXX /FLEX or foot switch or handset)</p> | <p>B CU155 MEDITOUCH</p> <p>D IPROXX /AC MEDITOUCH, IPROXX /SAT MEDITOUCH, IPROXX /FLEX MEDITOUCH</p> <p>F Optional short-circuit plug: Not use with FURNIBUS control units!</p> |
|--|---|

► We reserve the right to make unannounced technical changes in the course of our continual product improvement process!

3.2 Version: Handset

The control system consists of a number of distinct components. In order to use the system, the following components are required: a control unit (MCL or SG(AG)300) and a IPROXX /AC, IPROXX /FLEX or IPROXX /SAT control systems.

► No usage with the IPROXX AC /FLEX /SAT control system (version: MEDITOUCH)

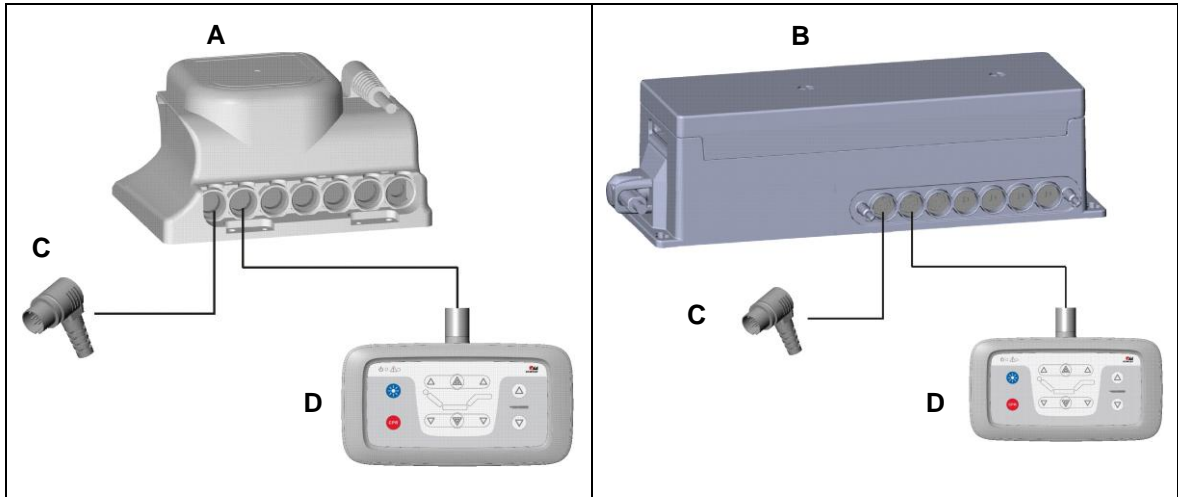

Figure 4 Control unit and handset – a sample configuration

A MCL control unit

B SG(AG)300 control unit

C short-circuit plug or locking device

D IPROXX /AC,
IPROXX /SAT,
IPROXX /FLEX

► We reserve the right to make unannounced technical changes in the course of our continual product improvement process!

3.3 System components

The main components of the MEDITOUCH system are the CU155 MEDITOUCH and the IPROXX /AC, IPROXX /FLEX or IPROXX /SAT control system (version: MEDITOUCH).

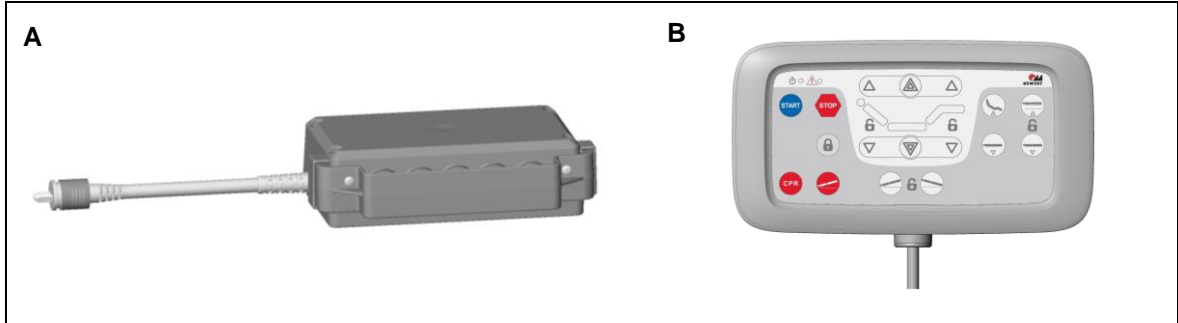

Figure 5 Example: The components of the MEDITOUCH control system

A CU155 MEDITOUCH

B IPROXX /AC MEDITOUCH,
IPROXX /SAT MEDITOUCH,
IPROXX /FLEX MEDITOUCH

3.3.1 CU155 MEDITOUCH

The CU155 MEDITOUCH is used to connect control systems(s) with the DewertOkin control unit. Up to four control systems can be connected. The CU155 MEDITOUCH is then plugged into the control unit.

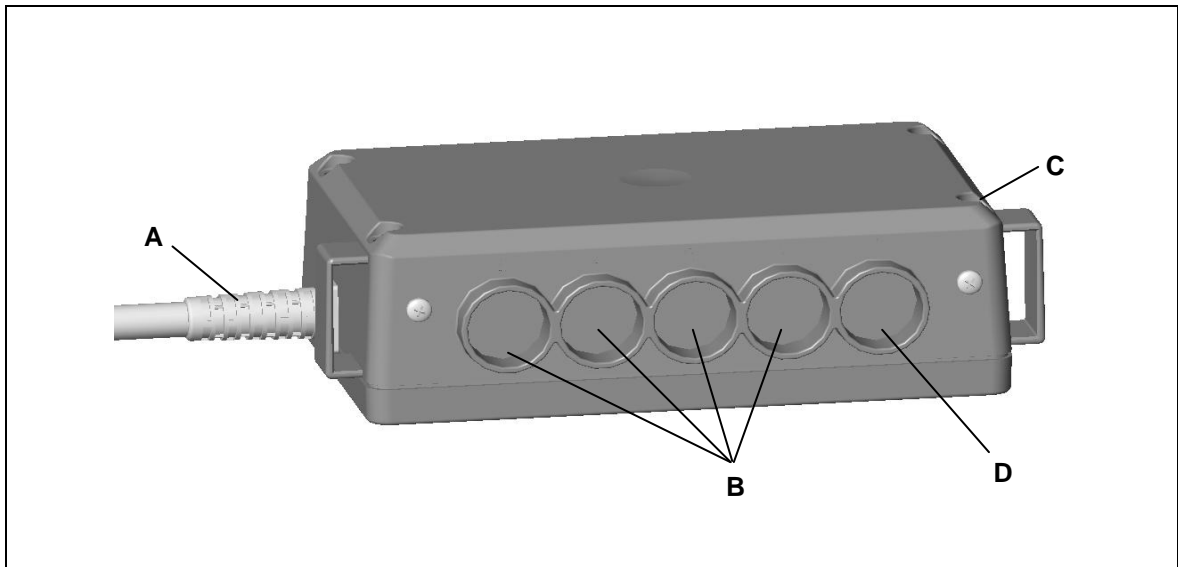

Figure 6 CU155 MEDITOUCH

A Connection to control unit

B Ports for the control systems
IPROXX /AC MEDITOUCH,
IPROXX /SAT MEDITOUCH
IPROXX /FLEX MEDITOUCH

C Optional: Lighting, or a floating (voltage-free) contact (can be used contacting the nurse)

D Optional: Another control system
(IPROXX /AC, IPROXX /SAT, IPROXX /FLEX or foot switch or handset)

3.3.2 IPROXX /AC /FLEX /SAT control system

The IPROXX /AC /FLEX /SAT control system from the MEDITOUCH system is used for entering the commands which control the application (end product).

The adjustment options can vary depending on the patient and medical staff. The MEDITOUCH system (the medical staff control system) allows medical staff to lock or enable the individual adjustment options on the application. The commands are then active for all connected control mechanisms. Only the medical staff control system can be used to control all of the extended function such as "Trendelenburg", swivel and the neutral position. The actual range of functions depends on the application and is customized according to the requirements of the customer. The patient control system IPROXX /AC, IPROXX /FLEX (MEDITOUCH) or IPROXX /SAT (MEDITOUCH) has a more limited range of simple adjustment options.

- ▶ The IPROXX /AC /FLEX /SAT control system's functionality and membrane keypad can be customized according to customer requirements. The following illustrations of the IPROXX / AC / FLEX / SAT control systems are examples; the design and functionality of your unit may vary.

3.3.3 IPROXX /AC /FLEX /SAT control system examples

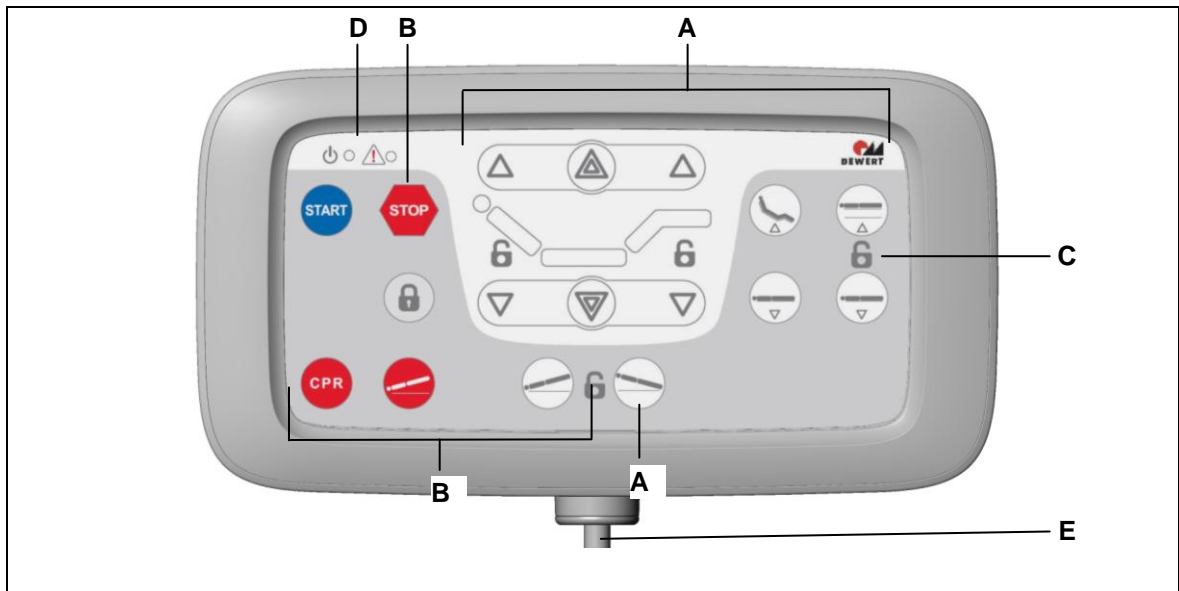

Figure 7 Example: IPROXX /AC MEDITOUCH „medical staff“

- A** Control keys
- B** Control keys exclusive “medical staff”
- C** Display of locked and unlocked functions (LEDs)
- D** LEDs (e.g. Power ON, CARE)
- E** Handset connecting cable

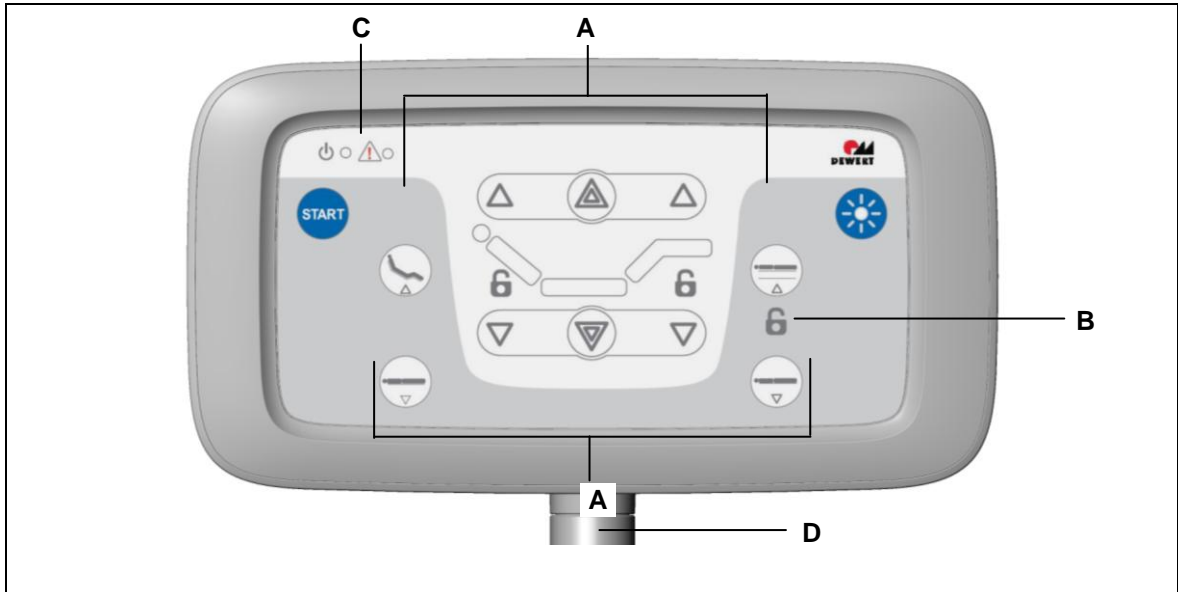

Figure 8 Example: IPROXX /FLEX MEDITOUCH „patient“

- | | |
|-------------------------------------|--|
| A Control keys | B Display of locked and unlocked functions (LEDs) |
| C LEDs (e.g. Power ON, CARE) | D Connection of handset holder |

3.3.4 Position of the handset holder IPROXX /FLEX /SAT

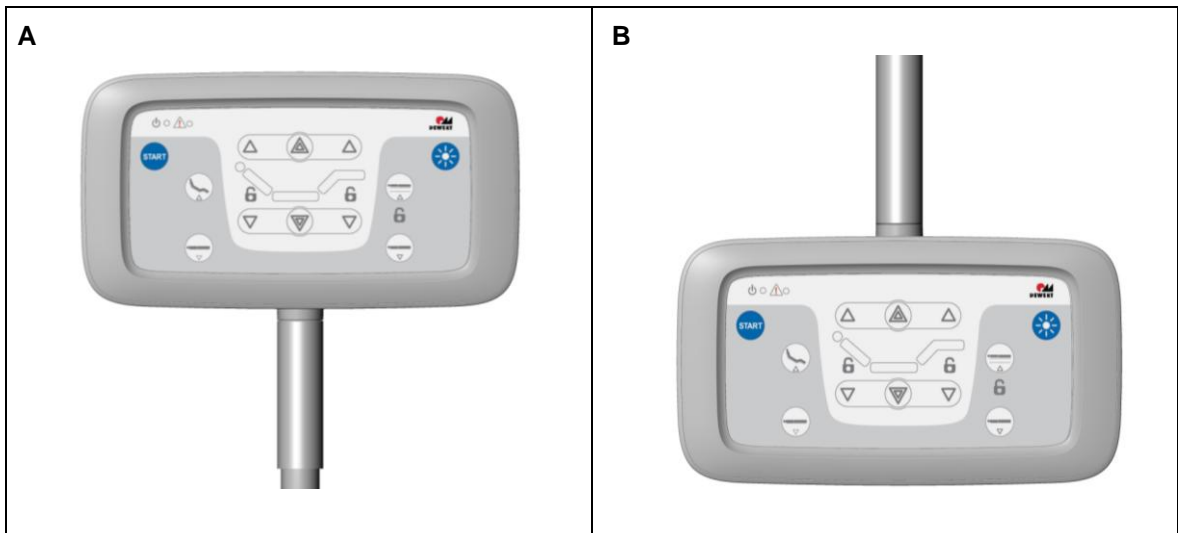

Figure 9 Position of the handset holder

- | | |
|-----------------------|----------------------|
| A IPROXX /FLEX | B IPROXX /SAT |
|-----------------------|----------------------|

4. Technical Specifications

4.1 CU155 MEDITOUCH and IPROXX /AC /FLEX /SAT

Input voltage CU155 MEDITOUCH	24 V DC - 29 V DC
Input voltage IPROXX /AC /FLEX /SAT	24 V DC - 29V DC
Permitted total current consumption when outputs are under load	max. 400 mA DC
Permitted load for lighting output (optional) ¹⁾	max. 50 mA DC (for 24 V DC LED variant: floating (voltage-free) contact, 24 V DC / max. 300 mA)
Permitted load on output for IPROXX /AC /FLEX /SAT	max. 50 mA DC per output Take into consideration the total current consumption!
Mode of operation ²⁾ at maximum load on outputs	Intermittent Operation 2 min ON./18 min OFF
Protection classification	III
Protection category for CU155 MEDITOUCH	IP54 (IP66 available on request)
Protection category for IPROXX /AC /FLEX /SAT	IPX4/IPX6
Dimensions and weight	
Length x width x height of CU155 MEDITOUCH	approx. 157 x 107 x 44 mm
Weight of CU155 MEDITOUCH	approx. 300 g
Length x width x height of IPROXX /AC /FLEX /SAT	approx. 238 x 128 x 34 mm (without handset holder, without mounting clip)
Weight of IPROXX /AC	approx. 0,6 kg
IPROXX /FLEX	approx. 1,6 kg
IPROXX /SAT	approx. 1,9 kg
Length handset holder (IPROXX /FLEX /SAT)	600 mm or 1000 mm

Ambient conditions for operation, storage and transport	
Ambient room temperature for storage and transport	from -20 °C to +50 °C from -4 °F to +122 °F
Ambient room temperature for operation	from +10 °C to +40 °C from +50 °F to +104 °F
Relative humidity	from 30% to 75%
Air pressure	from 800 hPa to 1060 hPa
Altitude	< 2000 m

- 1) Ask your customer representative for more information.
- 2) Mode of operation: intermittent operation 2 min. ON/18 min. OFF. This means that after the system is operated with its rated load for up to 2 minutes it must then be paused for 18 minutes. The system can malfunction if this pause is not observed!

4.1.1 Dimensions of the CU155 MEDITOUCH

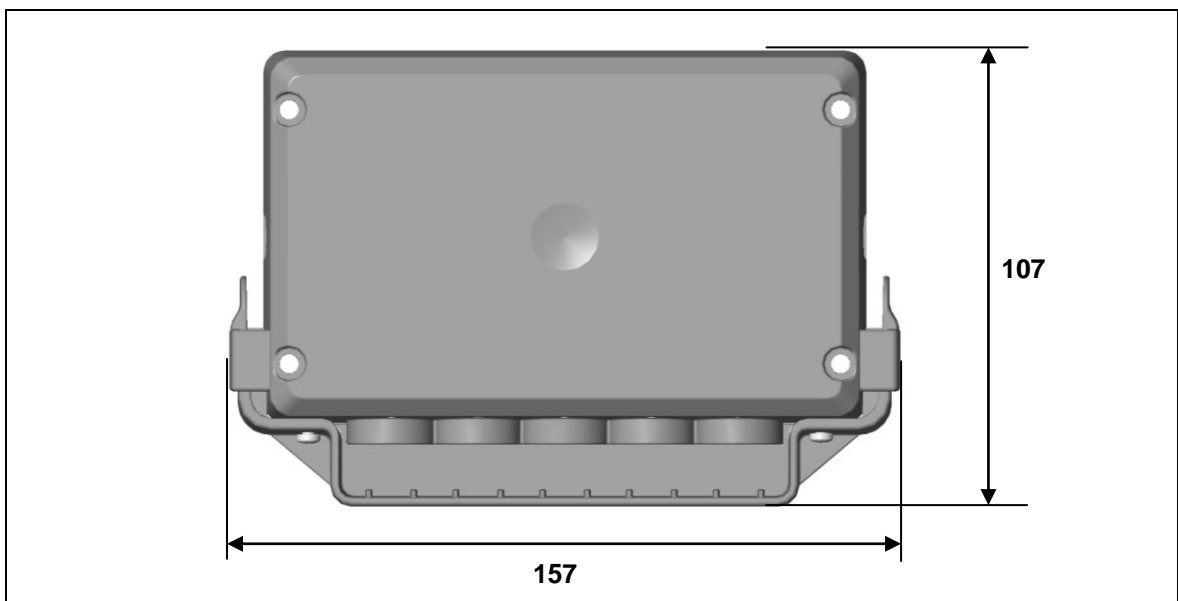

Figure 10 Dimensions of the CU155 MEDITOUCH (in mm), top view

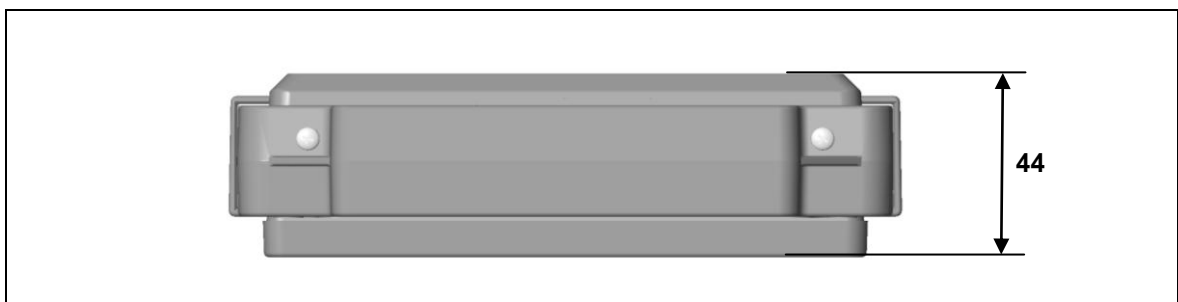

Figure 11 Dimensions of the CU155 MEDITOUCH (in mm), front view

4.1.2 Dimensions of the IPROXX /AC /FLEX /SAT

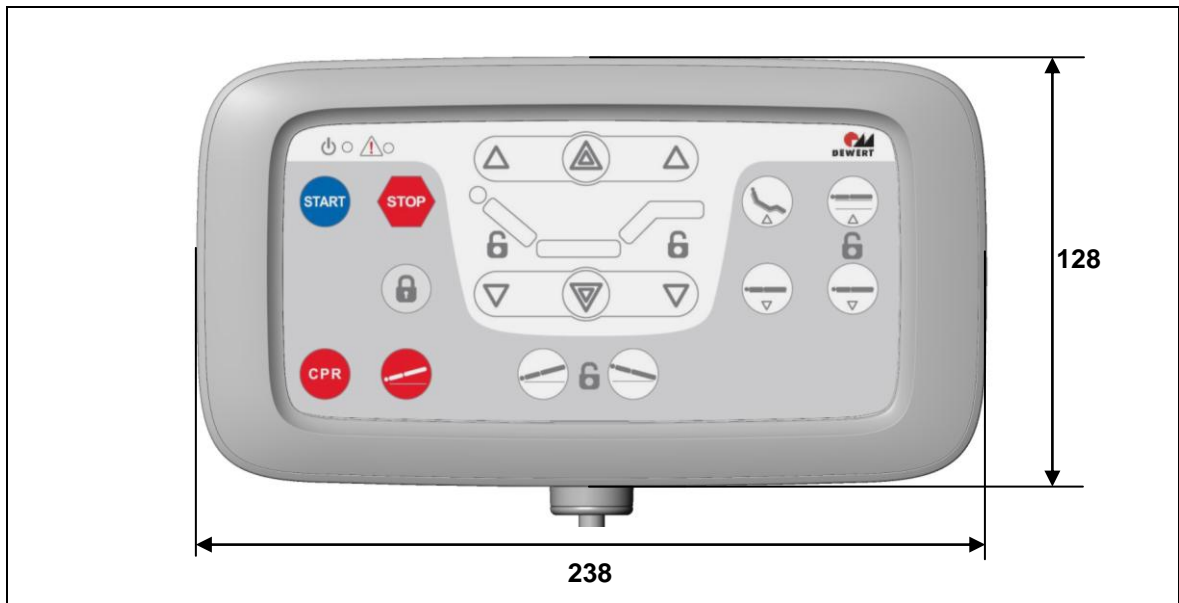

Figure 12 Dimensions of the IPROXX /AC /FLEX /SAT, (in mm), top view

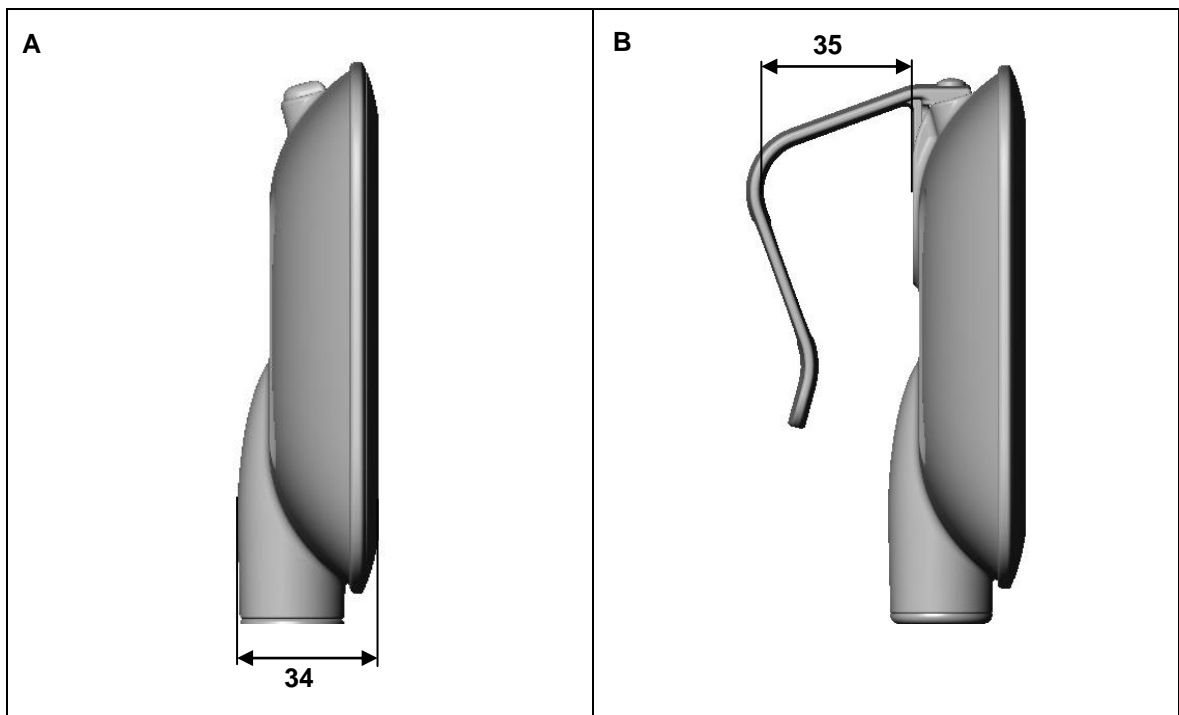

Figure 13 Dimensions of the IPROXX /AC /FLEX /SAT, (in mm), side view

A IPROXX /AC /FLEX /SAT

B IPROXX /AC

5. Installation

5.1 Safety notices to observe during installation

Basic safety rules must be followed in order to ensure that the end product can be continually operated in a safe manner. These rules must be observed while using the end product.

⚠ CAUTION
<div style="display: flex; align-items: center;"> <div> <p>Electrical components should be connected and disconnected only when no voltage is present.</p> <p>The manufacturer of the end product is responsible for implementing a proper strain relief mechanism for the cable.</p> </div> </div>

5.2 Installation procedure

Before installing the control system, make sure that you are observing all of the safety notices found in the "Safety notices to observe during installation" section.

5.2.1 Installation and dismantling for the CU155 MEDITOUCH

There are four mounting holes in the CU155 MEDITOUCH which can be used to attach it to the end product with the appropriate screws (for example, M4 x 50 screws). The CU155 MEDITOUCH should be mounted so that it lies flat against its supporting material. In the end product, no mechanical forces (such as torsion) should be put on the CU155 MEDITOUCH or enclosure. Such forces could lead to damage (such as cracks) in the housing.

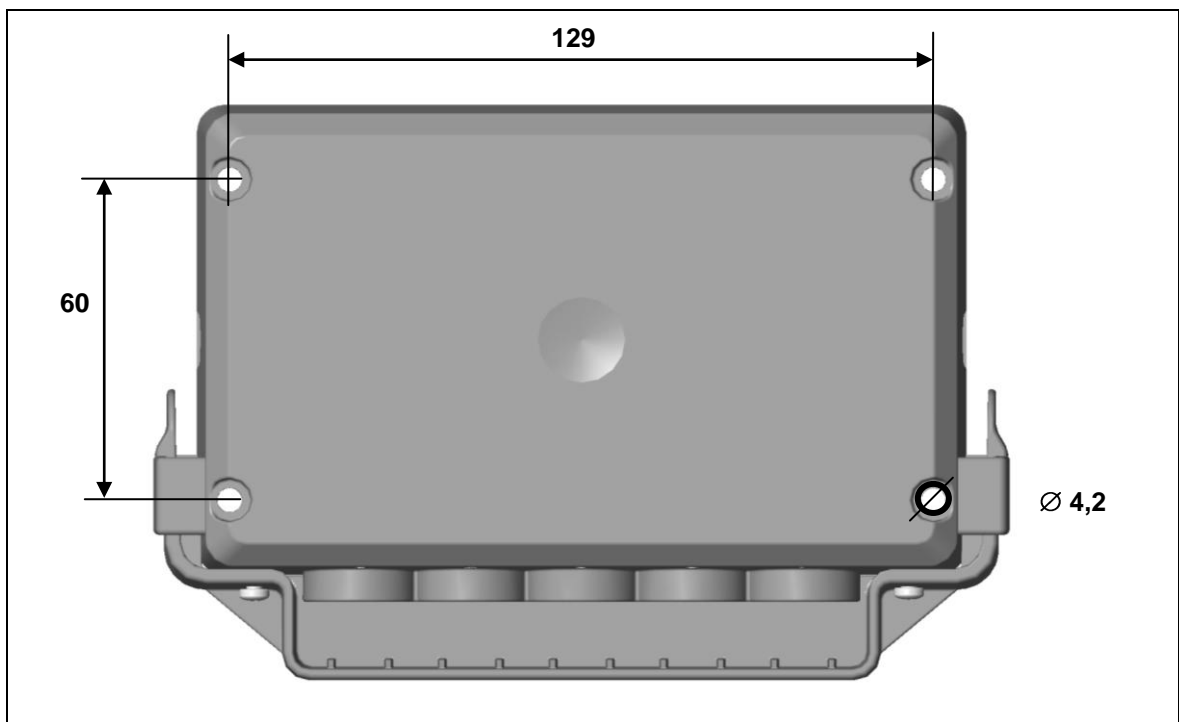

Figure 14 CU155 MEDITOUCH mounting holes (in mm)

5.2.2 Installation of the IPROXX /FLEX /SAT control system to the application

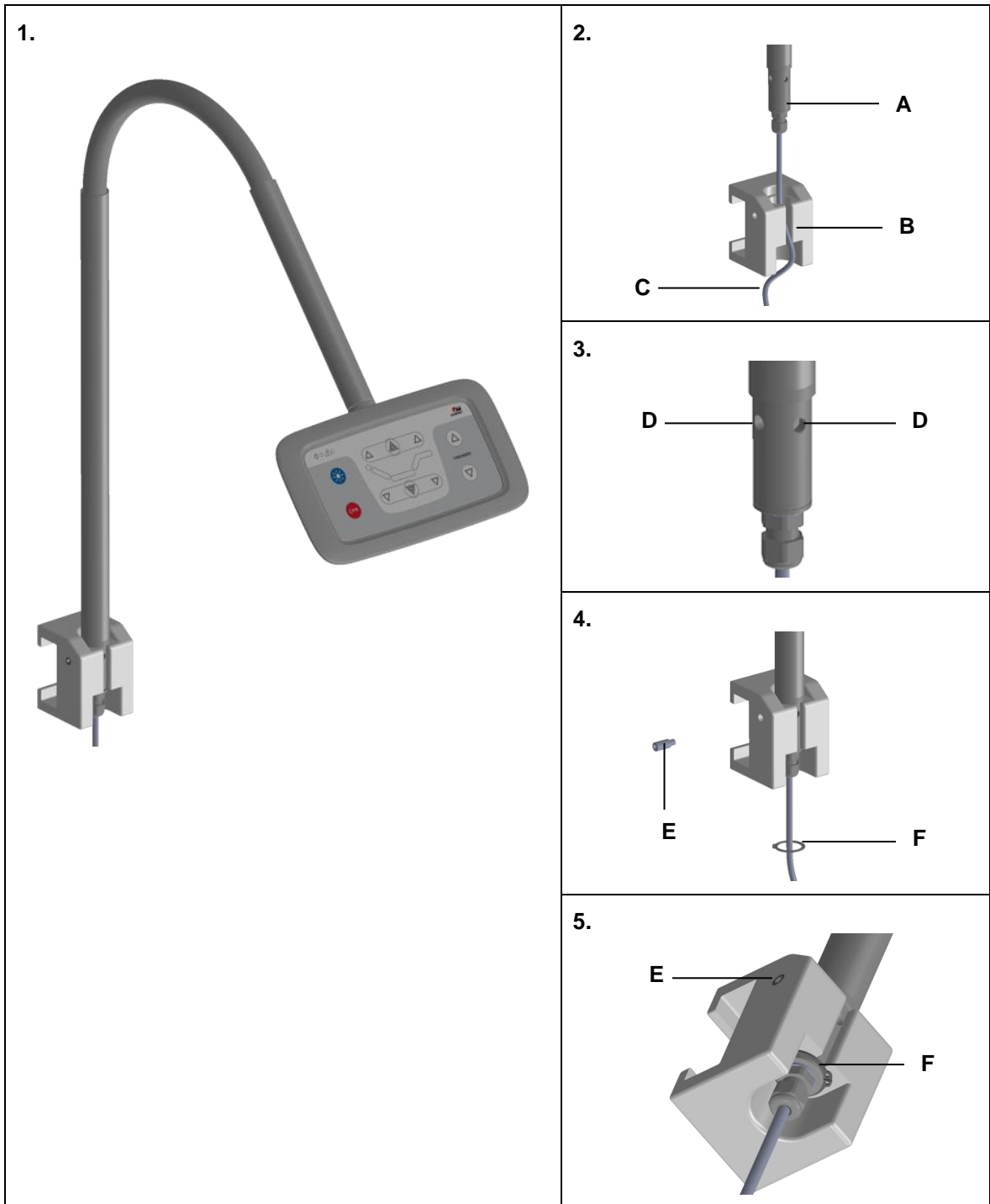

Figure 15 Example: Mounting of the IPROXX /FLEX /SAT (Figure: IPROXX /SAT)

A Fixing point of the handset holder

B Example: Handset holder mount tot he end product.

C Connecting cable of the handset

D Fixing holes (0°, 90°, 180°, 270°) from the handset holder

E Set screw M8 DIN 915/ISO4028

F Retaining ring Ø22 DIN471

The following illustration is an example of an IPROXX /FLEX /SAT control system mounted to an end product.

► Aufgrund technischer Veränderungen sind Abweichungen im Detail möglich.

- 1 Slide the handset holder attachment (A) down into the handset holder (B). Thread the handset cable (C) through the slot of the handset holder (B).
- 2 Slide the retaining ring (F) over the handset cable (C). Then put it in the groove of the handset holder attachment (A) (refer to Figure 15). The IPROXX /FLEX /SAT control system can be rotated 360° in the handset holder.
- 3 In order to lock the IPROXX /FLEX /SAT control system in position (0°, 90°, 180° or 270°), insert the set screw (E) through the handset holder attachment (B) and into the retainer hole (D). The set screw (E) must be screwed all the way into the hole.

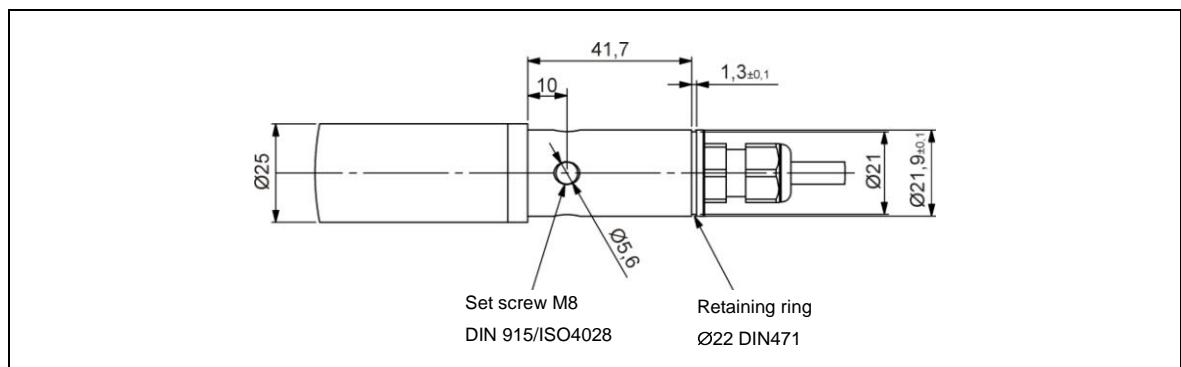

Figure 16 Dimensionen of the handset holder fixing point (in mm)

5.2.3 Fixing the IPROXX /AC control system to the application

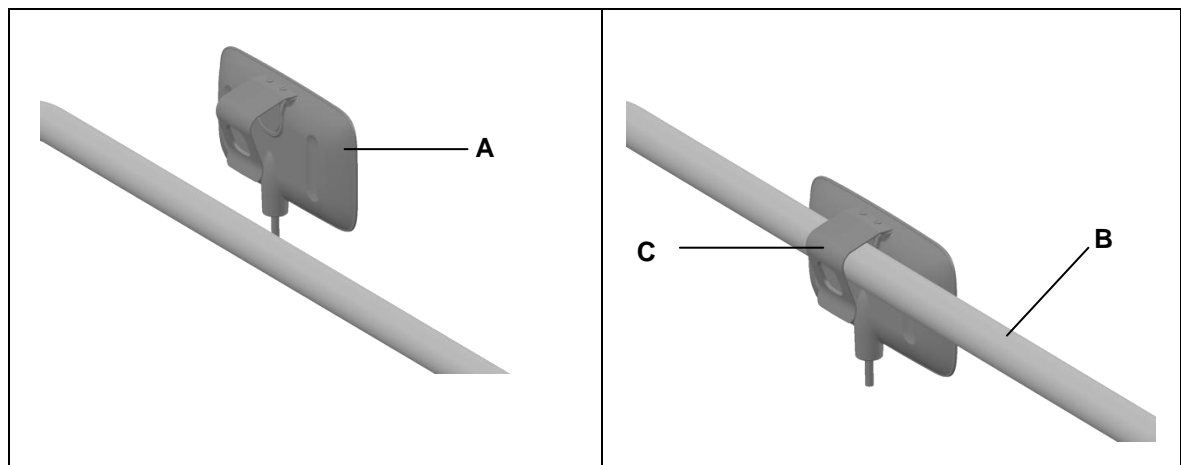

Figure 17 Fixing of the IPROXX /AC

A IPROXX /AC

C Bed frame (e.g. Ø 35 mm)

B Handset hook

For fixing the IPROXX /AC control system, move the handset hook over the bed frame.

5.2.4 Rotating the IPROXX /FLEX /SAT control system

The handset unit of the IPROXX /FLEX /SAT control system can be rotated 180°.

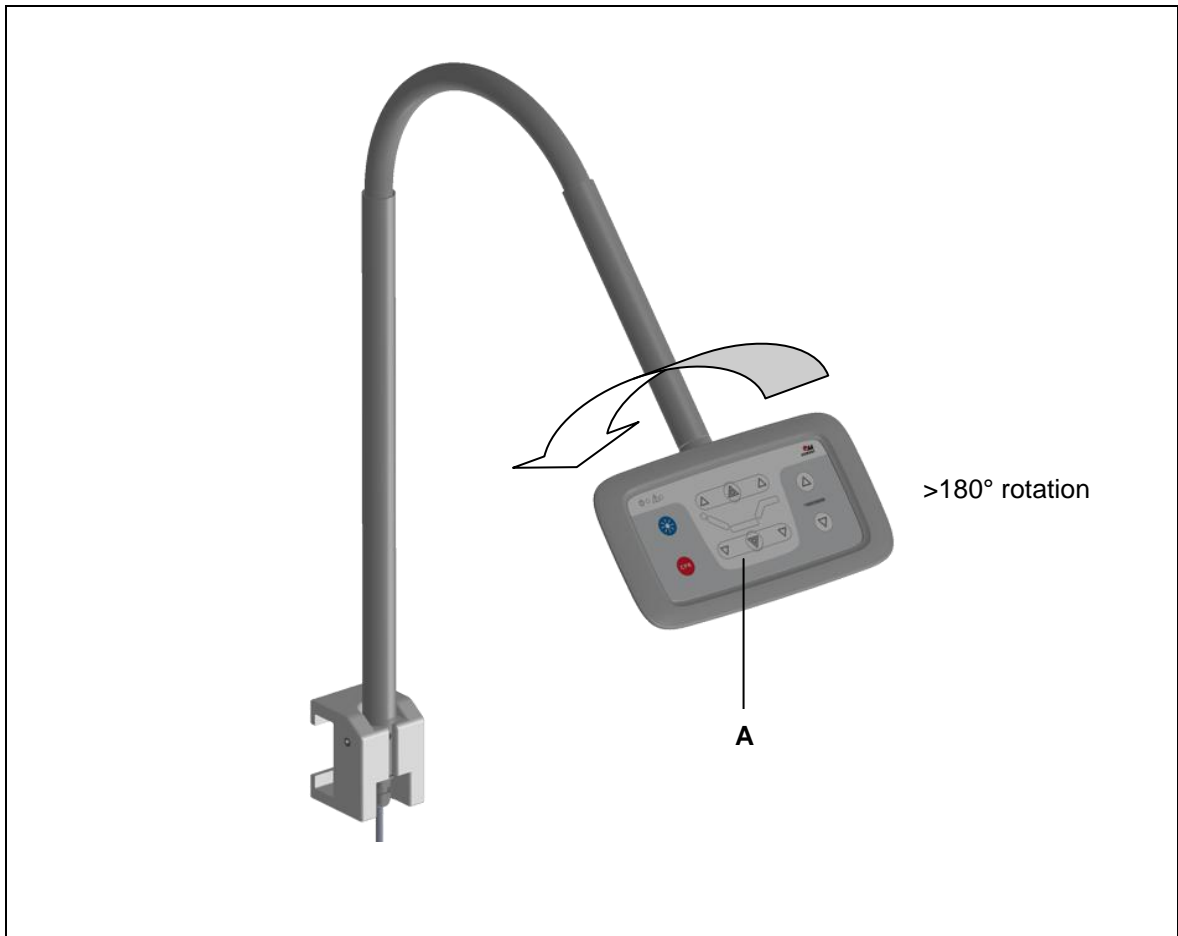



Figure 18 Rotating the IPROXX /FLEX /SAT control system

A Example: IPROXX /SAT

5.2.5 Connecting the IPROXX /AC /FLEX /SAT control system to the CU155 MEDITOUCH

⚠ CAUTION	
	<p>First connect the IPROXX /AC /FLEX /SAT control system (version: MEDITOUCH) to the CU155 MEDITOUCH (always start from socket 2).</p> <p>Version „MEDITOUCH“: from socket 2 to 5</p> <p>Version „cable handset“: socket 1</p>

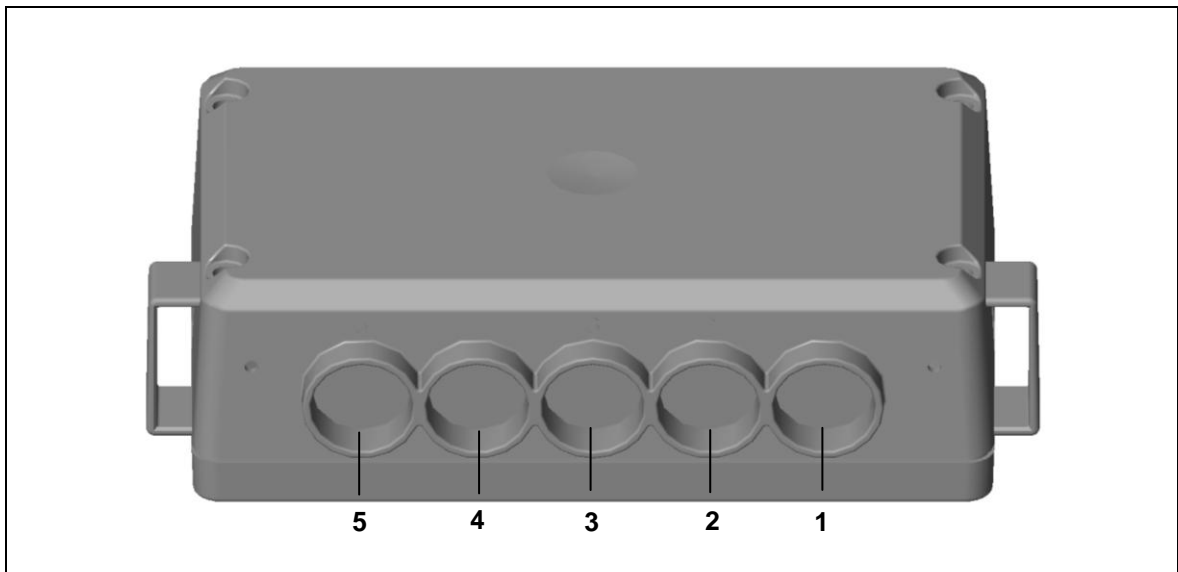



Figure 19 Connecting the IPROXX /AC /FLEX /SAT control system (version: MEDITOUCH) to the CU155 MEDITOUCH, sockets 2 - 5

WARNING	
	<p>Make sure that the unoccupied slots on the CU155 MEDITOUCH and the control units are sealed with dummy plugs.</p> <p>The protection category cannot be maintained when they are left unsealed.</p>

5.2.6 Electrical connection

Your operating instructions for the end product must notify the user that the cables (the power cable in particular) should not be run over and should not be subject to mechanical loads.

When routing the cables, be sure that:

- the cables cannot get jammed,
- no mechanical load (such as pulling, pushing or bending) will be put on the cables and
- the cables cannot be damaged in any way.

Make sure that all cables (especially the power cable) are fitted to the application with sufficient strain-relief and kink-prevention mechanisms. Be sure that the design of the end product prevents the connecting cables from coming into contact with the floor during transport.

	WARNING
	Always connect the IPROXX /AC /FLEX /SAT control system (version: MEDITOUCH) in the following sequence:

- 1 First connect the IPROXX /AC, IPROXX /FLEX or IPROXX /SAT control system (version: MEDITOUCH) to the CU155 MEDITOUCH, start with socket 2.
- 2 If necessary, then connect the control system (e.g. IPROXX AC /FLEX /SAT, version: cable handset) to the CU155 MEDITOUCH, plug to socket 1.
- 3 Install the pull-out protection (see page 24).
- 4 Connect the CU155 MEDITOUCH to the control unit.
- 5 Plug the power connector from the DewertOkin control unit into the power outlet only after all components are connected to the CU155 MEDITOUCH.

5.2.7 Mounting the pull-out protection over the sockets

The pull-out protection is attached to the CU155 MEDITOUCH by snapping it into the guide slots. It must be additionally fastened to the CU155 MEDITOUCH using suitable screws (ST 2.9 x 6.5; ISO 7049).

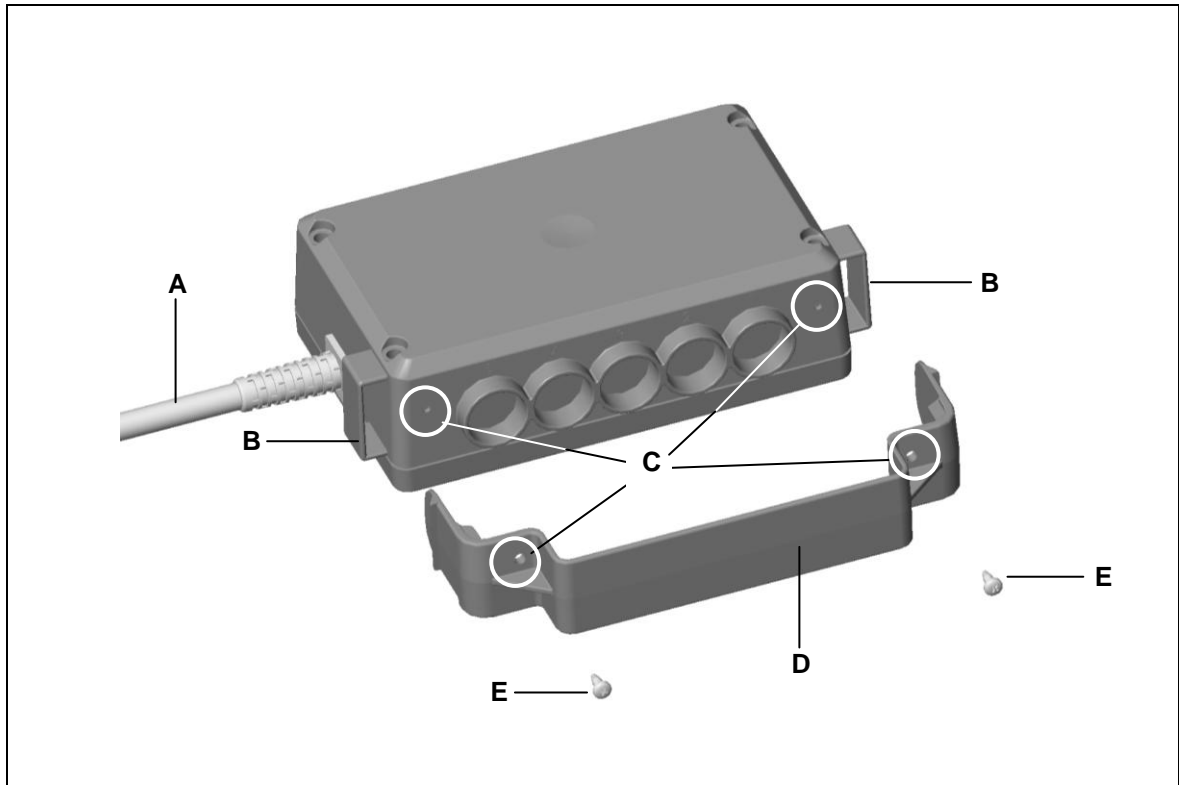

Figure 20 CU155 MEDITOUCH and pull-out protection

A Connecting cable to control unit

B Guide slots



C Holes for screws

D Pull-out protection

E Screws



6. Notices for Operation

The factual information contained within may be used when you are creating the end-product manual. The installation instructions do not contain all information required for the safe operation of the end product. They only describe the installation of the control system as a partially assembled piece of machinery.



	 CAUTION
	<p>When creating the operating instructions, remember that the installation instructions are intended for qualified specialists and are not for typical users of the end product.</p>

6.1 General notices

Single fault safety



	 CAUTION
	<p>Only the locked functions have single fault protection!</p>

Emergency shutoff of a connected drive or control unit



	 CAUTION
	<p>In case of an emergency, you can shut down the drive by disconnecting the power plug or battery plug from the control unit and the CU155 MEDITOUCH plug from the control unit. The power plug must always be accessible during operations so that emergency shutoff is possible</p>

Avoiding cable damage



Be sure that your operating instructions inform the user about the possible cable risks.

	 CAUTION
	<p>The cables (particularly the connecting cable) should not be run over. In order to prevent injuries or drive damage, no mechanical strain should be placed on the cables.</p>

6.2 Starting the MEDITOUCH system for the first time

	 CAUTION
	<p>Electrical components should be connected and disconnected only when no voltage is present.</p> <p>The manufacturer of the end product is responsible for implementing a proper strain relief mechanism for the cable.</p>

- 1 Before starting the system for the first time, connect the IPROXX /AC /FLEX /SAT (version: MEDITOUCH) to the CU155 MEDITOUCH.
- 2 If necessary, then connect the control system (version: cable handset) to the CU155 MEDITOUCH.
- 3 Then connect the CU155 MEDITOUCH with the DewertOkin control unit.

	 CAUTION
	<p>A short-circuit plug may not be used with the FURNIBUS version of the control unit (SG 300 / MCL)!</p>

6.2.1 Adding, replacing and disconnecting the IPROXX /AC /FLEX /SAT control system

The system must be reset each time that you add, remove or replace a IPROXX /AC /FLEX /SAT control system.

- 1 After you make a change to the system, pull out the CU155 MEDITOUCH connector from the controller. Leave unplugged for about ten seconds and then plug back in.



The MEDITOUCH control system will automatically carry out a self-test after the power supply is reconnected. The LED will flash on and off. The LEDs will go out after a few seconds or after you press a key.

Using the the IPROXX /AC /FLEX /SAT control system

Operating instructions for your customer-specific IPROXX /AC / FLEX / SAT control system can be obtained from the supplier or manufacturer of the keypad.

7. Troubleshooting

This chapter describes troubleshooting methods for fixing problems. If you experience an error that is not listed in this table, please contact your supplier.

	 CAUTION
	<p>Only qualified specialists who have received electrician training should carry out troubleshooting and repairs.</p>

Problem	Possible cause	Remedy
The MEDITOUCH control system or drive system is not functioning	The MEDITOUCH control system or the control unit is broken	Please contact your supplier or sales agent
	There is no mains supply voltage	Check the lead-in connections and re-seat the contacts if required
	The system does not recognize the IPROXX /AC /FLEX /SAT control system	Reset the control system (refer to the "Starting the MEDITOUCH system for the first time" section)
No movements can be carried out on the end product	The MEDITOUCH control system may be locked	Check and unlock the adjustment motion functions on the IPROXX /AC /FLEX /SAT control system
	A lead-in connection has been interrupted (mains power, auxiliary drive or handset)	Check the lead-in connections and re-seat the contacts if required
The "CARE" LED is permanently lit on the control system (or is blinking when no key is pressed)	The MEDITOUCH control system or the control unit is broken	Please contact your supplier or sales agent
The control unit is not reacting normally and functioning improperly when keys are pressed	The IPROXX /AC /FLEX /SAT control system (version: MEDITOUCH) may be locked	Check and unlock the adjustment motion functions on the IPROXX /AC /FLEX /SAT control system
	The MEDITOUCH control system or the control unit is broken	Please contact your supplier or sales agent
The LEDs flash continuously (longer than ten seconds) after the power supply is connected	The system starts and the flashing stops after about ten seconds	System is okay
	The MEDITOUCH control system or the control unit is broken.	Please contact your supplier or sales agent
The "CARE" LED does not go out after a key has been pressed	The MEDITOUCH control system or the control unit is broken.	Please contact your supplier or sales agent
The Lock LED is flashing	There is an error in the IPROXX /AC /FLEX /SAT control system	Unlock the corresponding key or adjustment function

8. Maintenance

	CAUTION
	You should only use spare parts which have been manufactured or approved by DewertOkin. Only these parts will guarantee a sufficient level of safety.

8.1 Maintenance

Type of check	Explanation	Time interval
Check the function and safety of the electrical system.	A qualified electrician should carry out this inspection. (Refer to the "Electrical connection" section in the "Installation" Chapter.)	Periodic inspections can be carried out at intervals based on the risk assessment which you conduct for your end product.
Periodic visual inspection for housing damage.	Check the housing for breaks or cracks. The IP protection will be impaired by any breakage or cracks.	At least every six months.
Periodic visual inspection of the plug-in connections and electrical access points for damage.	Check that all electrical cables and connections are firmly seated and correctly positioned.	At least every six months.
Periodic visual inspection for cable damage.	Check the connecting cables for pinching or shearing. Also check the strain relief and kink protections mechanisms, in particular after any mechanical load.	At least every six months.

8.2 Cleaning and care

The control system is easy to clean. Its smooth surfaces can be conveniently cleaned.

	WARNING
	Never clean the control system in an automated washing system or with a high-pressure cleaner. Do not allow fluids to penetrate the lighting. Damage to the system could result.

- 1 Always disconnect the mains power plug before you start to clean the control system!
- 2 Before starting to clean, disconnect the CU155 MEDITOUCH plug from the control unit.
- 3 Clean the control system using a moist cloth.
- 4 Be sure that you do not damage the connecting cables of the control system during the cleaning.

	WARNING
	Do not use a cleanser that contains benzene, alcohol or similar solvents.

9. Disposal

9.1 Packaging material

The packaging material should be sorted into recyclable component parts and recycled or disposed of in accordance with the relevant environmental regulations in the respective country (in Germany according to the Recycling Act KrWG dated 1 June 2013, internationally the EU directive 2008/98/EC (Waste framework directive WFD dated 12 December 2008).

9.2 Control system components

The control system consists of electronic components, cables and metal and plastic parts. You should observe all corresponding national and regional environmental regulations when disposing of the control system.

The disposal of the end product is regulated in Germany by Elektro-G, internationally by the EU Directive 2012/19/EC (WEEE), or by any applicable national laws and regulations.



The control system should not be disposed of with normal household waste!

Additional information

IPROXX /AC /FLEX /SAT control system

The following standards and norms were used in the versions CARE and HOSP with at least IPX4, in accordance with EN 60601-1, IEC 60601-1, third Edition,

EN 60601-1, Section 7.8.1	Colours of indicating lights
EN 60601-1, Section 8.10	Components and wiring
EN 60601-1, Section 8.10.4.1	Operating voltage / Input voltage
EN 60601-1, Section 9.3	Hazards associated with surfaces, corners and edges
EN 60601-1, Section 11	Temperature
EN 60601-1, Section 13	Hazardous situation and fault conditions: 15W limited supply circuit
EN 60601-1, Section 15.4.7.1	Mechanical strength
EN 60601-1, Section 15.4.7.2	Accidental operation
EN 60601-1, Section 16.6	Leakage current: Touch current <100µA
EN 60601-1, Section 17	EMC

The following standards and norms were used in the versions HOSP with at least IPX4, in accordance with EN 60601-2-52, IEC 60601-2-52, third Edition, (Particular requirements for the safety and essential performance of medical beds), the following standards have been used,

EN 60601-2-52, Section 201.3.8	Applied Part B
EN 60601-2-52, Section 201.9.2.2.5	Hold to run controls / momentary contact switch
EN 60601-2-52, Section 201.9.2.3.1	Unintended movement: Means to deactivate IPROXX /AC in version MEDI or MEDITOUCH or SUPERVISOR, etc
EN 60601-2-52, Section 201.11.6.5.101	Ingress of water: min IPX4
EN 60601-2-52, Section 201.11.1.1	Temperature
EN 60601-2-52, Section 201.15.3.4.1	Falling test
EN 60601-2-52, Section 201.15.4.4	Indicator lights "Ready for Normal Use" not required
EN 60601-2-52, Section BB.3.3.3	Dimensions for handles
EN 60601-2-52, Section BB.3.4.1	Operating forces

EG-Konformitätserklärung

Nach Anhang IV der EMV-Richtlinie 2014/30/EU

Nach Anhang IV der EU-Niederspannungsrichtlinie 2014/35/EU

Nach Anhang VI der RoHS-Richtlinie 2011/65/EU (inkl. Delegierte Richtlinie (EU) 2015/863)

Der Hersteller

EU Declaration of Conformity

In compliance with Appendix IV of the EMC-Directive 2014/30/EU

In compliance with Appendix IV of the LVD-Directive 2014/35/EU

In compliance with Appendix VI of the EU RoHS Directive 2011/65/EU (incl. Commission delegated Directive (EU) 2015/863)

The manufacturer

DewertOkin GmbH
Weststraße 1
32278 Kirchlegern
Deutschland - Germany

erklärt hiermit, dass das Produkt

declares that the following product

**IPROXX /AC
IPROXX /FLEX
IPROXX /SAT**

mit DewertOkin-Antriebssystem / with DewertOkin drive system

die Anforderungen folgender EG-Richtlinien erfüllt:

meets the requirements of the following EU directives:

Richtlinie über elektromagnetische Verträglichkeit 2014/30/EU

Electromagnetic Compatibility Directive 2014/30/EU

Niederspannungsrichtlinie 2014/35/EU

Low Voltage Directive 2014/35/EU

DELEGIERTE RICHTLINIE (EU) 2015/863 DER KOMMISSION vom 31. März 2015 zur Änderung von Anhang II der Richtlinie 2011/65/EU des Europäischen Parlaments und des Rates hinsichtlich der Liste der Stoffe, die Beschränkungen unterliegen.

COMMISSION DELEGATED DIRECTIVE (EU) 2015/863 of 31 March 2015 amending Annex II to Directive 2011/65/EU of the European Parliament and of the Council as regards the list of restricted substances.

Angewendete Normen

Applied standards:

- EN 60335-1:2012/A11:2014
- EN 55014-1:2006/A1:2009/A2:2011
- EN 55014-2:1997/A1:2001/A2:2008
- EN 61000-3-2:2014
- EN 61000-3-3:2013
- EN 62233:2008

Konstruktive Änderungen, die Auswirkungen auf die in der Montageanleitung angegebenen technischen Daten und den bestimmungsgemäßen Gebrauch haben, das Produkt also wesentlich verändern, machen diese Konformitätserklärung ungültig!

This declaration of conformity is no longer valid if constructional changes are made which significantly change the drive system (i.e., which influence the technical specifications found in the instructions or the intended use)!



Kirchlegern, Germany 25 November 2019

Dr.-Ing. Josef G. Groß
Geschäftsführer / Managing Director

DewertOkin GmbH
Weststraße 1
32278 Kirchlengern, Germany
Tel: +49 (0)5223/979-0
Fax: +49 (0)5223/75182
<http://www.dewertokin.de>
Info@dewertokin.de

ID-Nr.: 77347