



Motorized boxspring mechanisms

2020 / 2021

GTE
+32 5133 64 30
info@GTE.be
www.gtebelgie.be

OKIN
+ 49 2261 80 58 60
info@okin.de
www.dewertokin.de



Motorized boxspring mechanisms

2020 /
2021

IN METAL
WE TRUST



Table of contents

Welcome

Boxspring mechanism for dual actuators

- Duomotion 4-fold built-in-mechanism	04
- Duomotion 4-fold lay-in-mechanism	06
- Duomotion 5-fold built-in-mechanism	08
- Duomotion 4-fold built-in-mechanism	10

Boxspring mechanism for single actuators

- Technomotion 4-fold 3M built-in-built-up-mechanism	12
- Technomotion 4-fold 2M built-in-built-up-mechanism	14
- Technomotion 4-fold 4M built-in-built-up-mechanism	16
- Techno 5 fold slide back system	18
- Split-frame 4-fold 2-mechanism	20

Lift mechanism

- Lift mechanism 2x linear actuator (one module)	22
- Lift mechanism 2x linear actuator (two modules)	24
- Lift mechanism 1x linear actuator	26

Partlist	28
-----------------	-----------



FOR TAILOR MADE BEDFRAMES,
NIGHTSTANDS, MATRASS BRAKES,
ETC. PLEASE CONTACT
GTE BELGIUM
HILLE-ZUID 10
8750 ZWEVEZELE

CONTACT US
+32 5133 64 30
info@GTE.be
www.gtebelgie.be

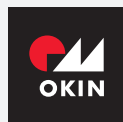

DEWERTOKIN GMBH
WESTSTRASSE 1
32278 KIRCHLENGERN

CONTACT US
+ 49 2261 80 58 60
info@okin.de
www.dewertokin.de

Boxspring mechanism for dual actuators

Duomotion 4-fold built-in-mechanism

Designed as a built-in set. The mechanic fits inside the upholstered wooden plinth of a Boxspring.

| BUILT-IN FRAME

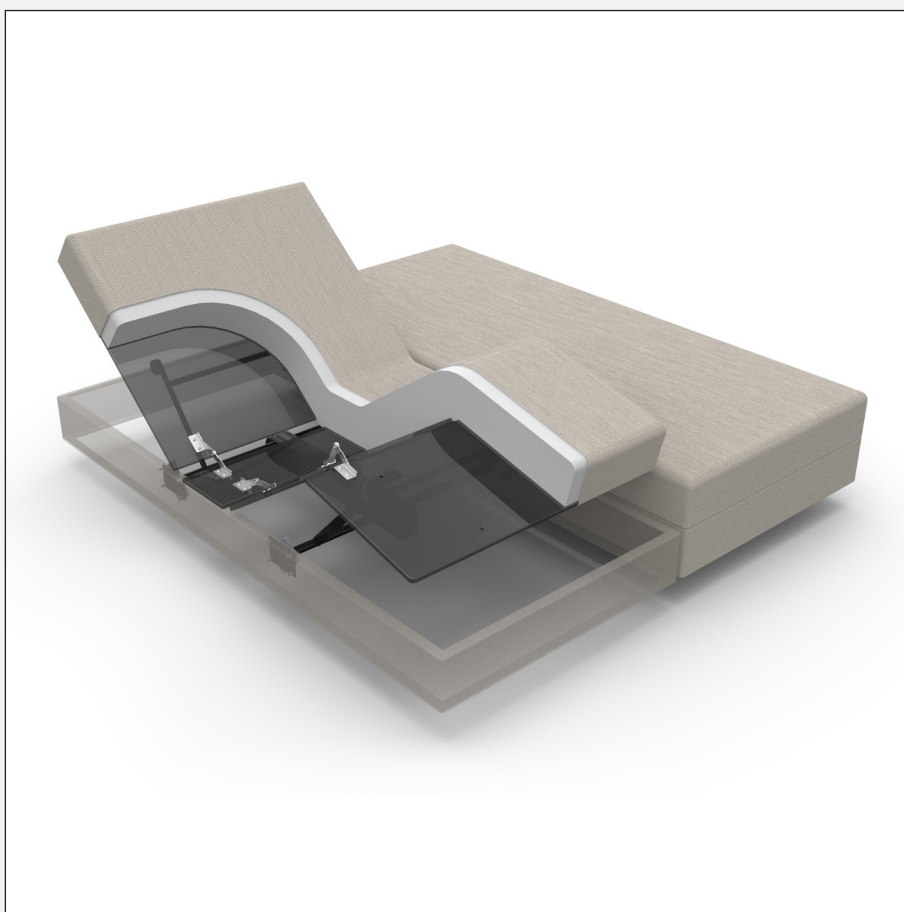

upholstered frame



double drive



4-fold

| stock product

For further details regarding motorisation:



For further details regarding mechanism:



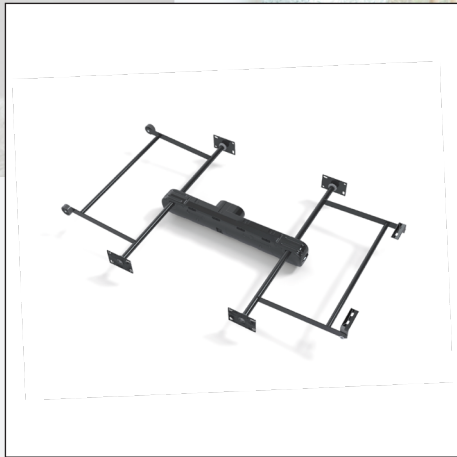

Technical information

1. THE MECHANISM

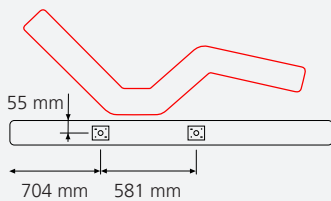
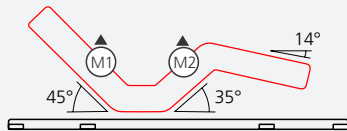

built-in position

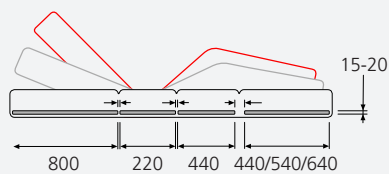

geometry of the adjustable frameparts

2. THE MOTORISATION



FOR PART-LIST

Consult **page: 28 - ROW A**

Alternative actuators and handsets on request



integrated
SMPS



WORLDWIDE



<0.5W
STANDBY



HIGH POWER



OVERLOAD
PROTECTED



noiseless



high tensile
steel



self
lubricating



reinforced
hook

bedsize	width	art.n°
70	623-633	B200169
80	723-763	B200170
90	823-863	B200171
100	923-963	B200172
120	1123-1163	B200369

Boxspring mechanism for dual actuators

Duomotion 4-fold lay-in-mechanism

Designed as a built-in set. The mechanic fits inside the upholstered wooden plinth of a Boxspring.

LAY-IN FRAME

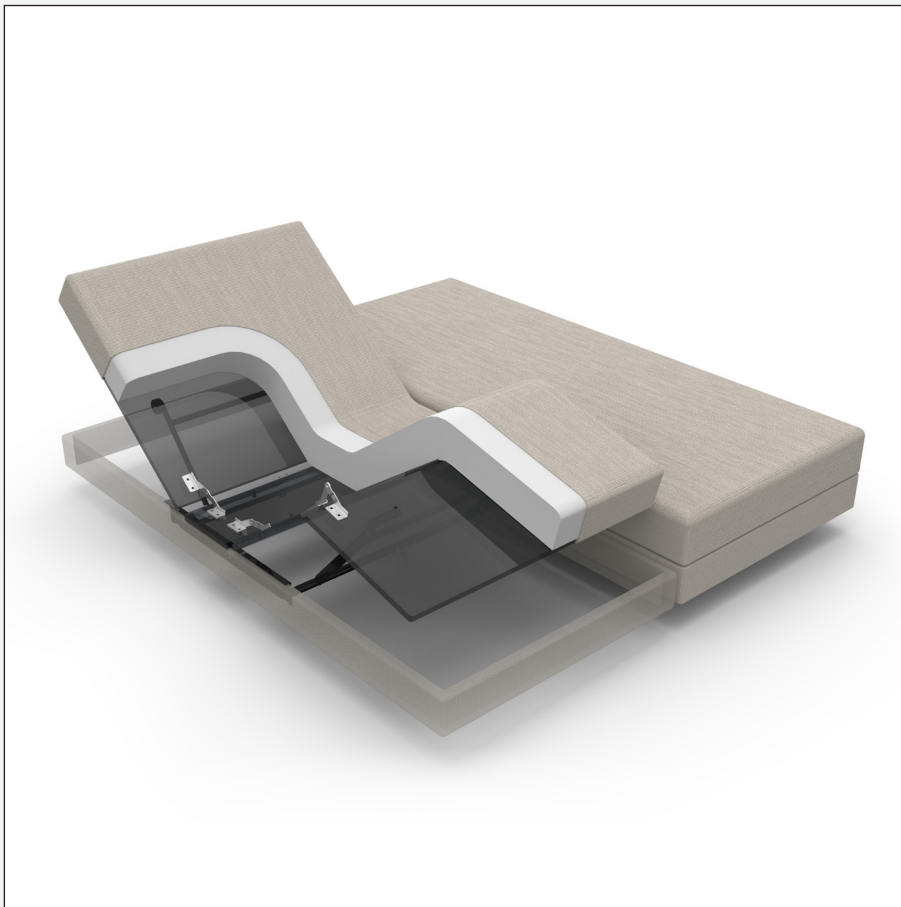

upholstered frame

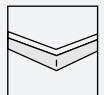

metal frame



4-fold

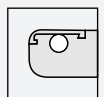

double drive

easy installation.
Pre-mounted module
with fixed tube
distance 581mm

For further details
regarding motorisation:



For further details
regarding mechanism:



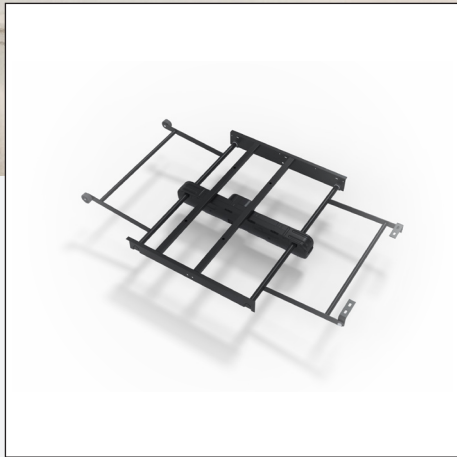

Technical information

1. THE MECHANISM

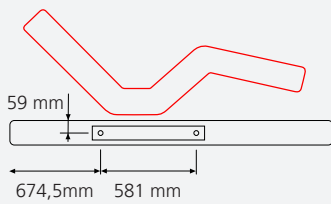
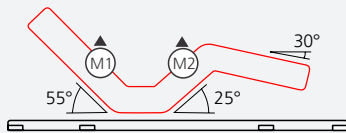

built-in position

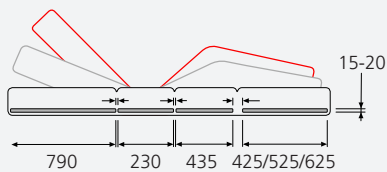

geometry of the adjustable frameparts

2. THE MOTORISATION



FOR PART-LIST

Consult **page: 28 - ROW B**

Alternative actuators and handsets on request



integrated
SMPS



WORLDWIDE



<0.5W
STANDBY



2X
6500N



OVERLOAD
PROTECTED



noiseless



self
lubricating



stability



reinforced
hook

bedsize	width	art.n°
80	740	B200520
90	840	B200521
100	940	B200522

Boxspring mechanism for dual actuators

Duomotion 5-fold built-in-mechanism

Designed as a built-in set. The mechanic fits inside the upholstered wooden plinth of a Boxspring.

| BUILT-IN FRAME

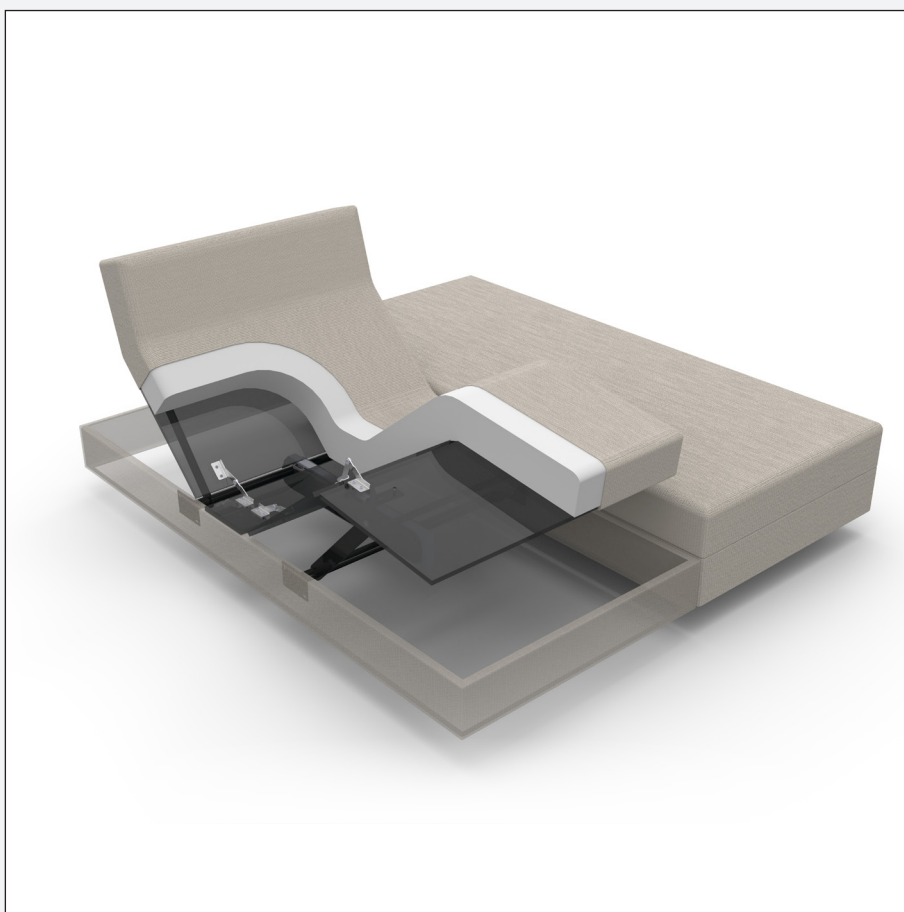

upholstered frame



double drive



5-fold

For further details regarding motorisation:



For further details regarding mechanism:





Technical information

1. THE MECHANISM

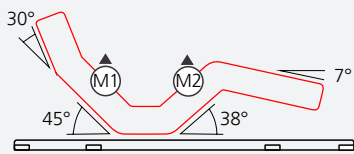

maximum angles

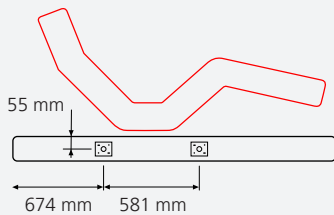

built-in position

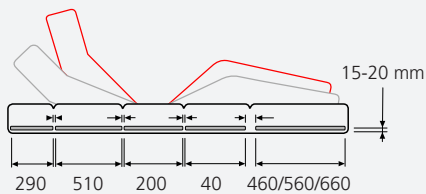

geometry of the adjustable frameparts

2. THE MOTORISATION



FOR PART-LIST

Consult **page: 28 - ROW C**

Alternative actuators and handsets on request



integrated
SMPS



WORLDWIDE



<0.5W
STANDBY



HIGH POWER



OVERLOAD
PROTECTED



noiseless



high tensile
steel



self
lubricating



reinforced
hook

bedsize	width	art.n°
70	634-660	B200494
80	734-760	B200495
90	834-860	B200496
100	934-960	B200497
120	1134-1160	B200498

Boxspring mechanism for dual actuators

Duomotion 4-fold built-up-mechanism

A stand alone, self-supporting metal frame.

Mechanism is built inside the metal frame.

Frame fits underneath a Boxspring.

Can be built with or without an upholstered wooden plinth.

| BUILT-UP FRAME

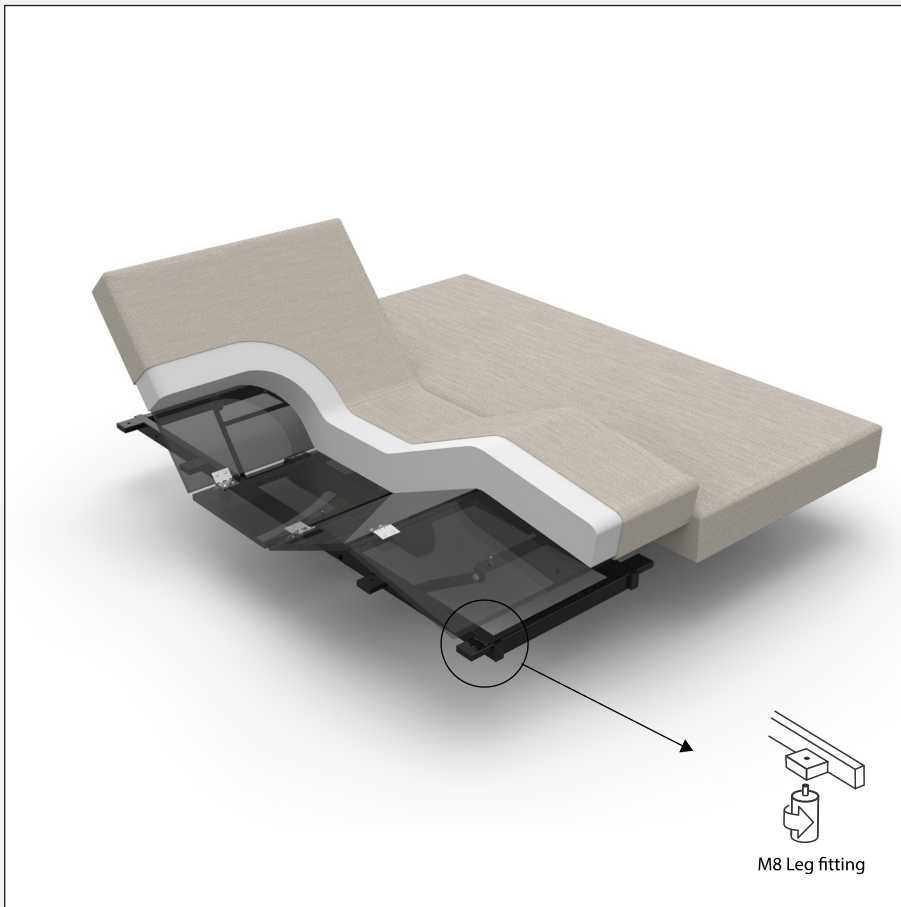

metal frame

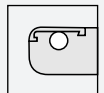

double drive



4-fold

M8 legs can be mounted on the corners.

For further details regarding motorisation:



For further details regarding mechanism:





Technical information

1. THE MECHANISM

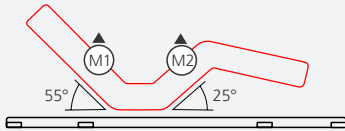

maximum angles

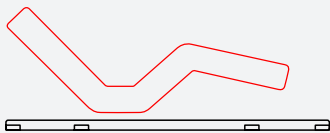

built-in position

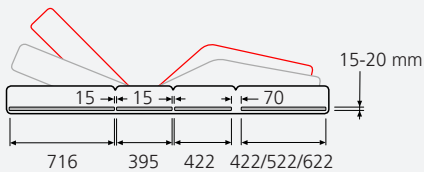

geometry of the adjustable frameparts

2. THE MOTORISATION



FOR PART-LIST

Consult **page: 28 - ROW D**

Alternative actuators and handsets on request



integrated
SMPS



WORLDWIDE



<0.5W
STANDBY



HIGH POWER



OVERLOAD
PROTECTED



noiseless



high tensile
steel



self
lubricating



reinforced
hook

bedsize	width	art.n°
80-90	550 (700)	B200577
100-120	900	B200578
80-90	700	B200058

Boxspring mechanism for single actuators

Technomotion 2M built-up-built-in-mechanism

Can be used as a stand-alone, self-supporting metal frame. Or can be built with or without an upholstered wooden plinth. Attachment points of the single drives are fixed on the wooden plates.

| BUILT-UP / BUILT-IN FRAME

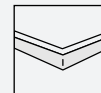
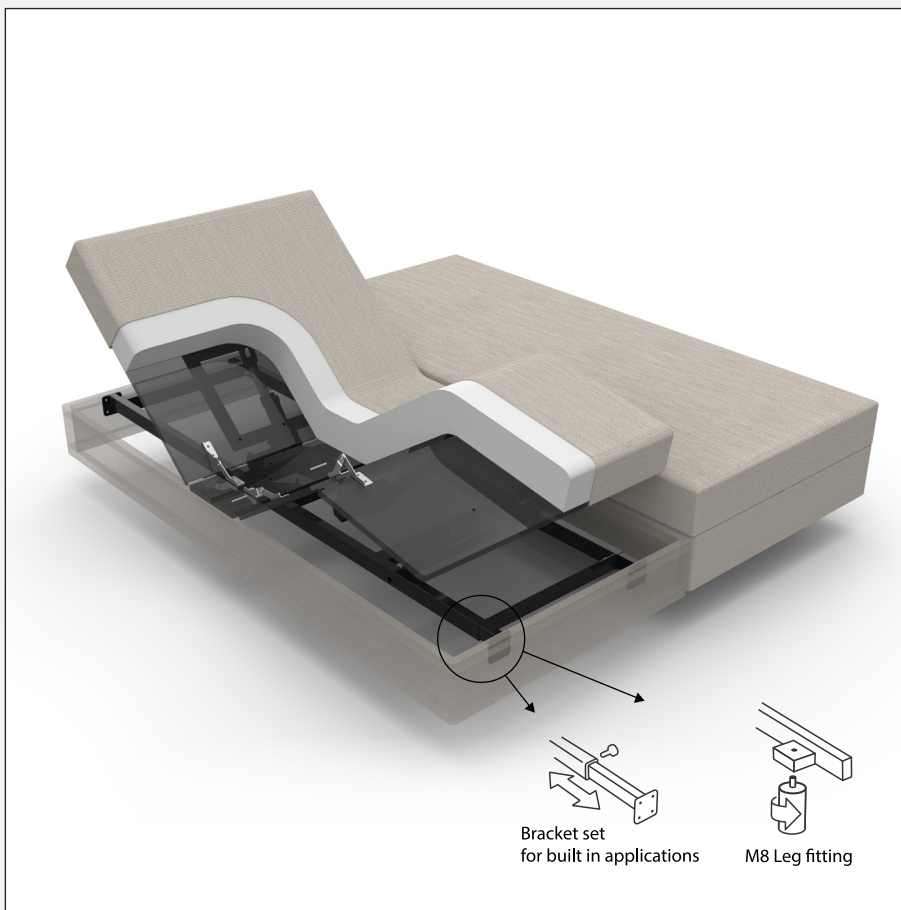

metal frame



2 motors



4-fold

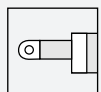

single drive

M8 legs can be mounted on the corners. Fitting inside upholstered bedframes with optional bracket set.

For further details regarding motorisation:



For further details regarding mechanism:



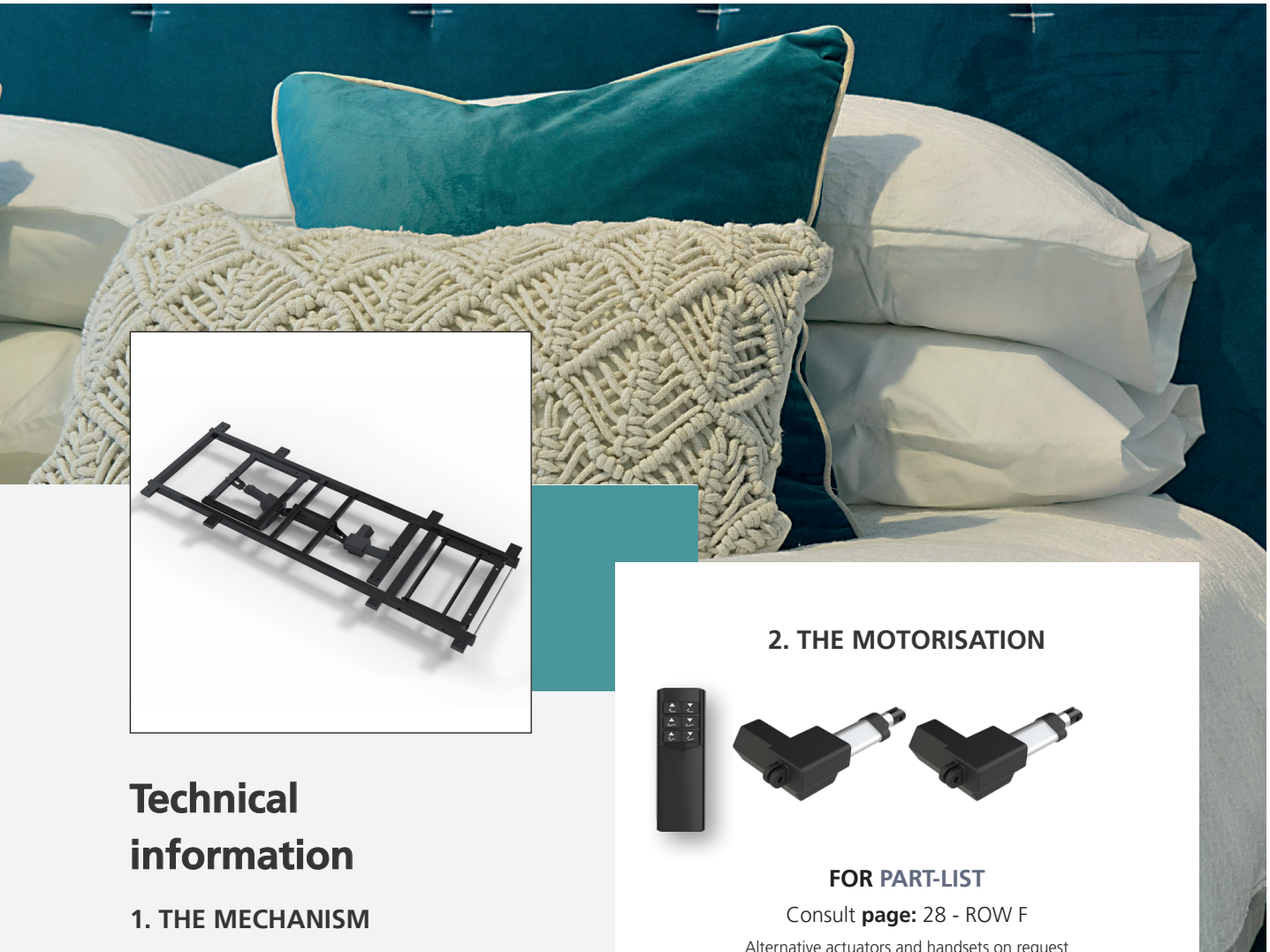

Technical information

1. THE MECHANISM

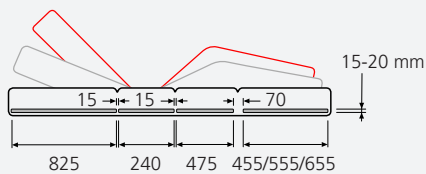
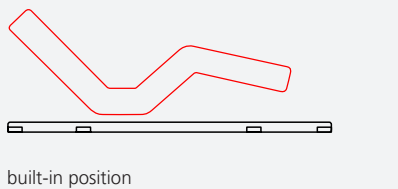
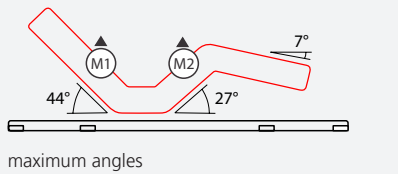

2. THE MOTORISATION

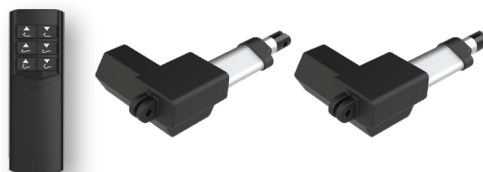

FOR PART-LIST

Consult **page: 28 - ROW F**

Alternative actuators and handsets on request



EXTERNAL
SMPS



WORLDWIDE



<0.5W
STANDBY



HEAVY DUTY



OVERLOAD
PROTECTED



noiseless



high tensile
steel



self
lubricating

bedsize	width	art.n°
80-90-100	550 (700)	B100920
120-140	900	B100921

Boxspring mechanism for single actuators

Technomotion 4-fold 3M built-up-built-in-mechanism

Can be used as a stand-alone, self-supporting metal frame. Or can be built with or without an upholstered wooden plinth. Attachment points of the single drives are fixed on the wooden plates.

| BUILT-UP / BUILT-IN FRAME

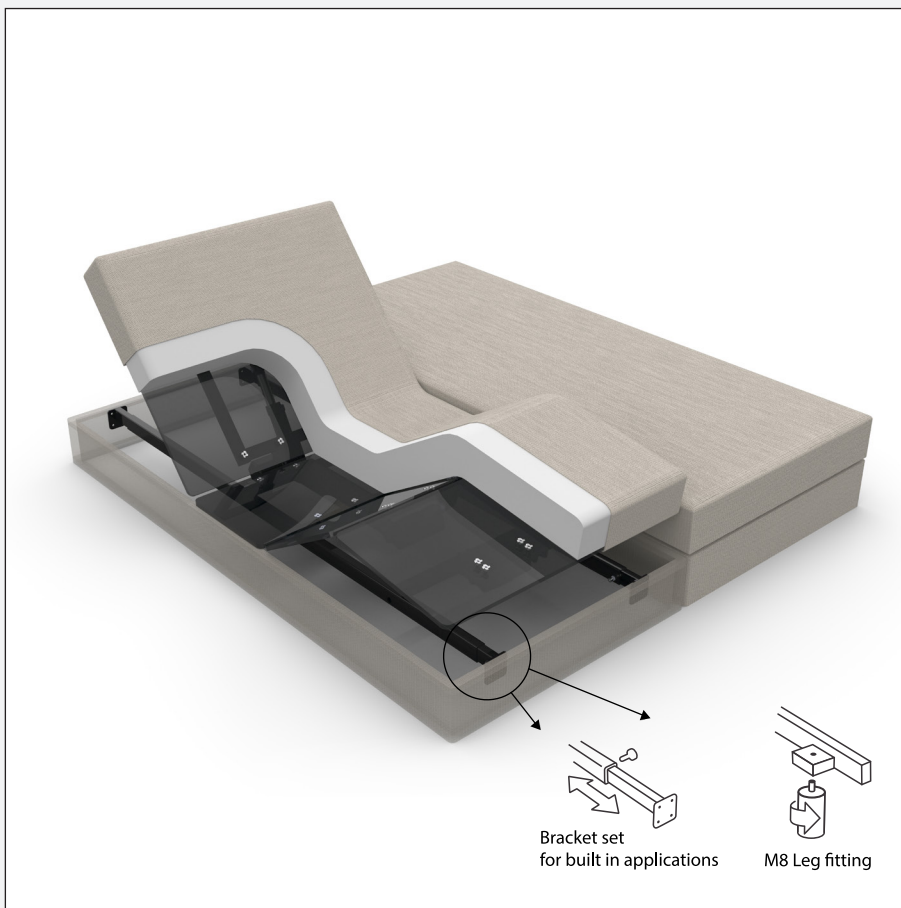

metal frame



3 motors



4-fold



single drive

M8 legs can be mounted on the corners. Fitting inside upholstered bedframes with optional bracket set.

For further details regarding motorisation:



For further details regarding mechanism:





Technical information

1. THE MECHANISM

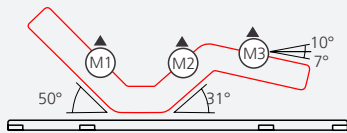

maximum angles

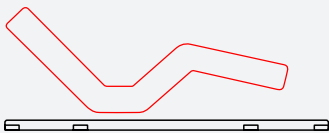

built-in position

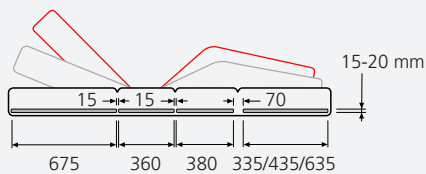

geometry of the adjustable frameparts

2. THE MOTORISATION



FOR PART-LIST

Consult **page: 28 - ROW E**

Alternative actuators and handsets on request



HEAVY DUTY



EXTERNAL SMPS



<0.5W STANDBY



6000N motor strength



OVERLOAD PROTECTED



AC 100/240V WORLDWIDE



noiseless



high tensile steel



self lubricating

bedsize	width	art.n°
80-90-100	580	B100892
120-140	980	B100893

Boxspring mechanism for single actuators

Technomotion 5-fold 4M built-up-built-in-mechanism

Can be used as a stand-alone, self-supporting metal frame. Or can be built with or without an upholstered wooden plinth. Attachment points of the single drives are fixed on the wooden plates.

| BUILT-UP / BUILT-IN FRAME

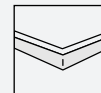
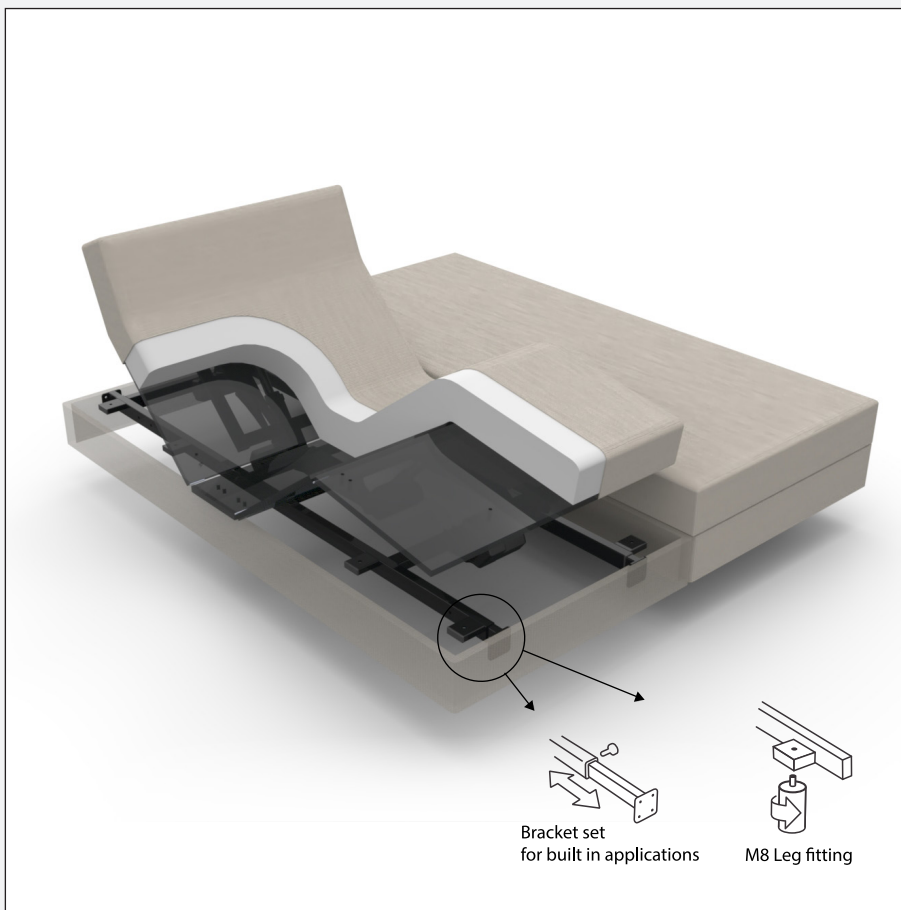

metal frame

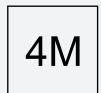

4 motors



5-fold

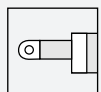

single drive

M8 legs can be mounted on the corners. Fitting inside upholstered bedframes with optional bracket set.

For further details regarding motorisation:



For further details regarding mechanism:





Technical information

1. THE MECHANISM

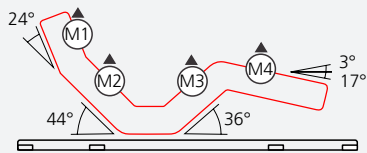

maximum angles

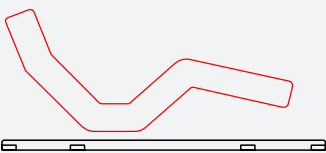

built-in position

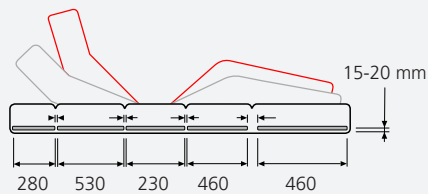

geometry of the adjustable frameparts

2. THE MOTORISATION



FOR PART-LIST

Consult **page: 28 - ROW G**

Alternative actuators and handsets on request



EXTERNAL
SMPS



WORLDWIDE



<0.5W
STANDBY



HEAVY DUTY



OVERLOAD
PROTECTED



noiseless



high tensile
steel



PA 6

self
lubricating

bedsize	width	art.n°
80-90-100	550 (700)	B100875
120-140	900	B100876

Boxspring mechanism for single actuators

Technomotion 5 fold slide back system

A stand alone, self-supporting metal frame.
Designed with a slide back function.
Built inside an upholstered wooden plinth.

| BUILT-UP / BUILT-IN FRAME

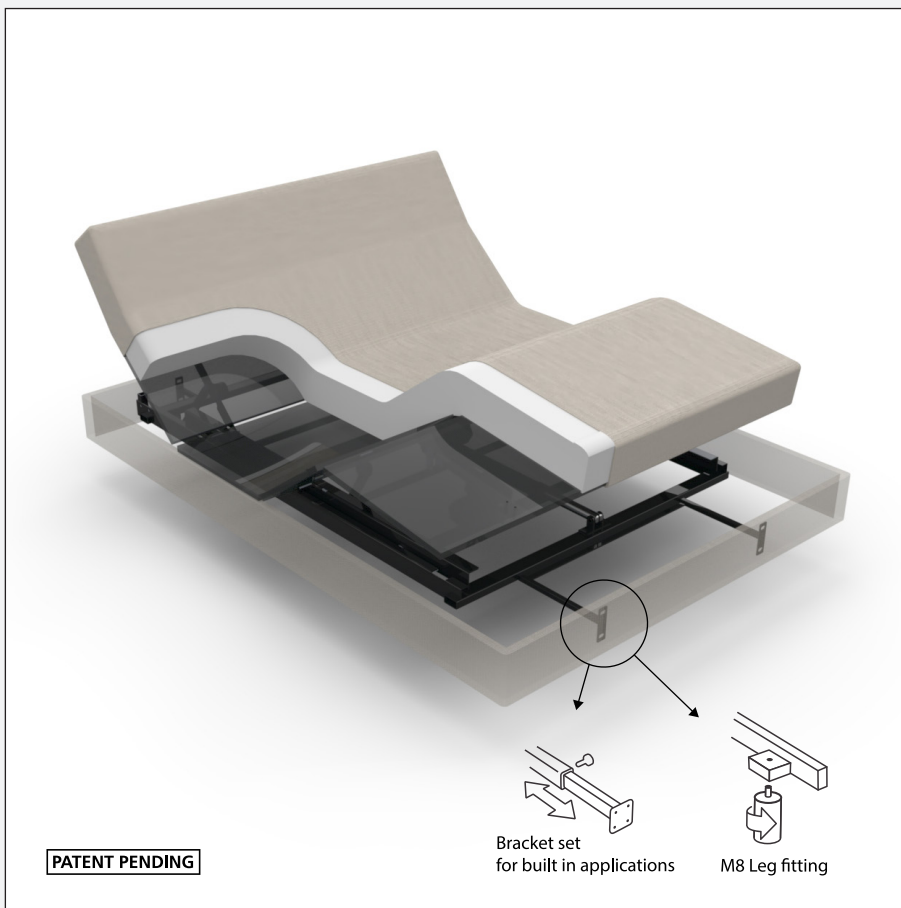

slide back system



2 motors



5-fold

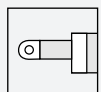

single drive

Slide-back function:
Top frame slides
back and forth while
adjusting the head
section.

For further details
regarding motorisation:



For further details
regarding mechanism:





Technical information

1. THE MECHANISM

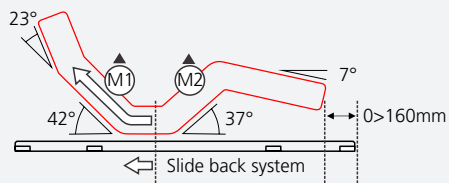

maximum angles

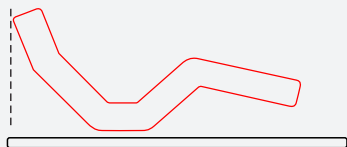

built-in position

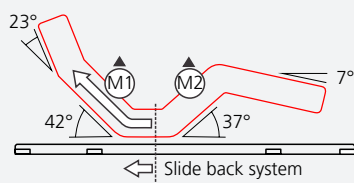

geometry of the adjustable frameparts

2. THE MOTORISATION

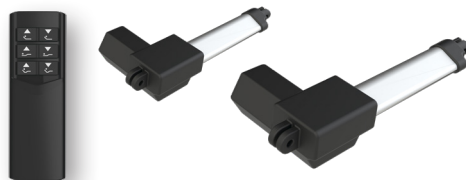

FOR PART-LIST

Consult **page: 29 - ROW K**

Alternative actuators and handsets on request



EXTERNAL
SMPS



WORLDWIDE



<0.5W
STANDBY



HEAVY DUTY



OVERLOAD
PROTECTED



noiseless



high tensile
steel



self
lubricating

bedsize	width	art.n°
80-90-100	674	B100916
120-140	1114	B100917

Boxspring mechanism for single actuators

Split-frame 4-fold 2-mechanism

A stand alone, self-supporting metal frame able to split into two separate parts. Attachment points of the single drives are fixed on the wooden plates. Can be built with or without an upholstered wooden plinth.

| BUILT-UP / BUILT-IN FRAME

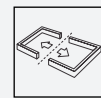
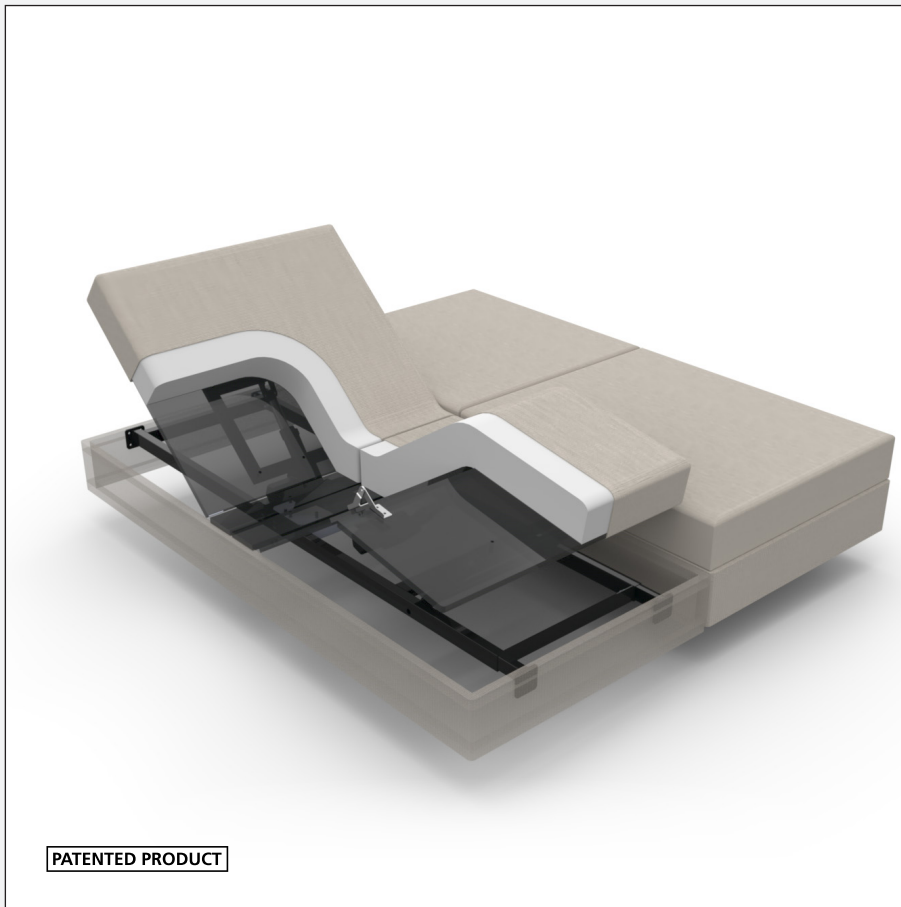

split-frame

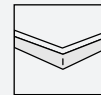

metal frame



2 motors



4-fold

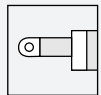

2 x single drive

Compact export packaging.

On the side feet can be mounted.

bed head side/ foot side can be upholstered separately

For further details regarding motorisation:



For further details regarding mechanism:





Technical information

1. THE MECHANISM

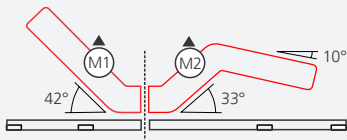

maximum angles

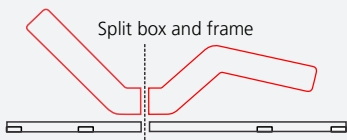

built-in position

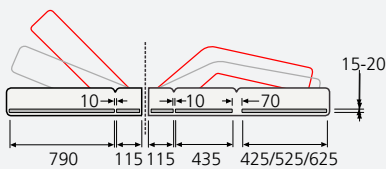

geometry of the adjustable frameparts

2. THE MOTORISATION

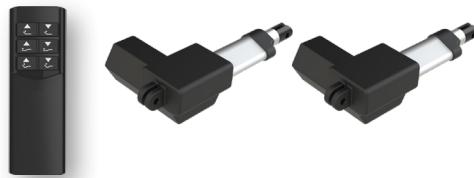

FOR PART-LIST

Consult **page: 29 - ROW L**

Alternative actuators and handsets on request



HEAVY DUTY



integrated SMPS



WORLDWIDE



<0.5W STANDBY



6000N motor strength



OVERLOAD PROTECTED



noiseless



high tensile steel



PA 6

self lubricating

bedsize	width	art.n°
80	550	B100934
90	650	B100935

Lift mechanisms

Lift mechanism 2x linear actuator (one module)

Liftsystem with two motors.
Designed to fit under any upholstered bed.

ONE MODULE - BUILT-IN



metal frame



2 motors



single drive

Lift can be used in combination with Duomotion 4-fold 2M BU mechanism. (B200058 p10-11)
Optional: mounting brackets, wheels, monkey bar and fallout security.

For further details regarding motorisation:



For further details regarding mechanism:





Technical information

1. THE MECHANISM

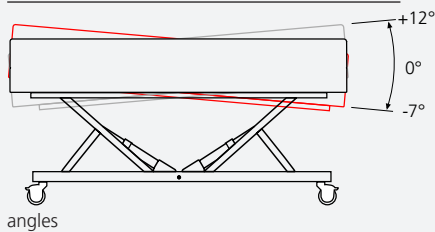
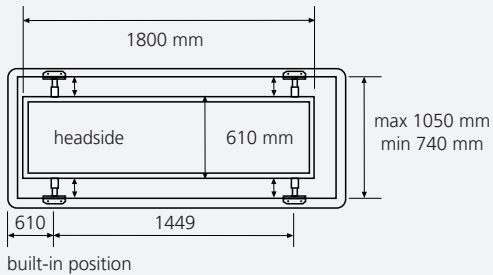
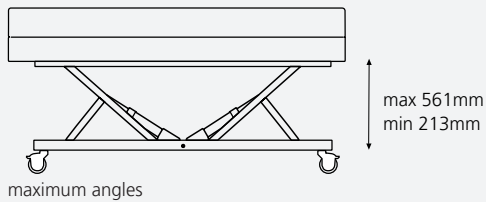

2. THE MOTORISATION

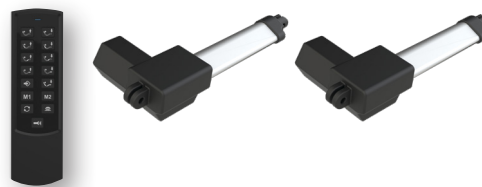

FOR PART-LIST

Consult **page: 29 - ROW H**

Alternative actuators and handsets on request



EXTERNAL
SMPS



WORLDWIDE



<0.5W
STANDBY



HEAVY DUTY



OVERLOAD
PROTECTED



noiseless



self lubricating



stability



tredelenburg

bedsize	length	art.n°
80-90-100 - 105	200-210-220	B100914

Lift mechanisms

Lift mechanism 2x linear actuator (two modules)

High-end liftsystem with two separate lifting coloms. Designed to fit under a special frame.

! TWO MODULES - BUILT-IN

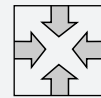

compact



2 motors

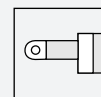

single drive

Lift B100825 can be used in combination with Duomotion 4-fold 2M BU (B100577 p10-11)
Lift B100826 can be used in combination with Duomotion 4-fold 2M BU. B100578 op p 10-11.

For further details regarding motorisation:



For further details regarding mechanism:





Technical information

1. THE MECHANISM

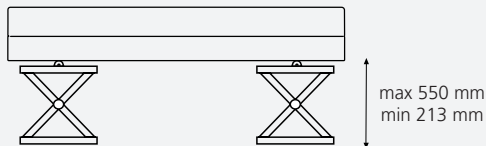

maximum angles

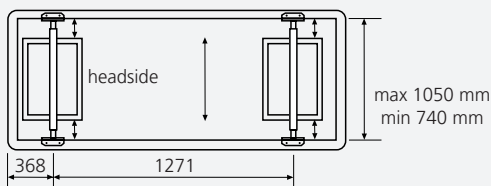

built-in position

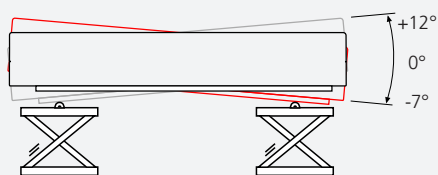

angles

2. THE MOTORISATION

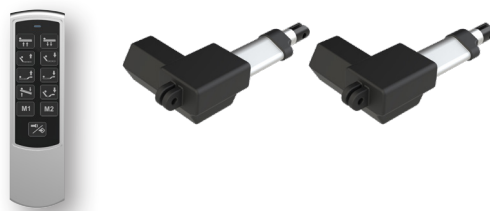

FOR PART-LIST

Consult **page: 29 - ROW I**

Alternative actuators and handsets on request



EXTERNAL
SMPS



WORLDWIDE



<0.5W
STANDBY



HEAVY DUTY



OVERLOAD
PROTECTED



noiseless



self
lubricating



stability



tredelenburg



anti-
trendelenburg

bedsize	length	art.n°
80-90	200-210-220	B100825
100-120	200-210-220	B100826

Lift mechanisms

Lift mechanism 1x linear actuator

Liftsystem with one motor. Wheels out function, meaning the ground frame can be pulled up so the bed can be moved on the wheels. Designed to fit under any upholstered bed with the use of a custom bracket.

| TWO MODULES - BUILT-IN



metal frame

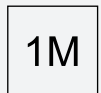

2 motors



single drive

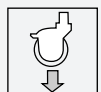

wheels out function

For further details regarding motorisation:



For further details regarding mechanism:





Technical information

1. THE MECHANISM

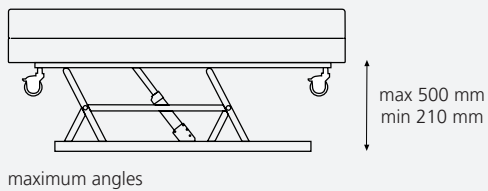

maximum angles

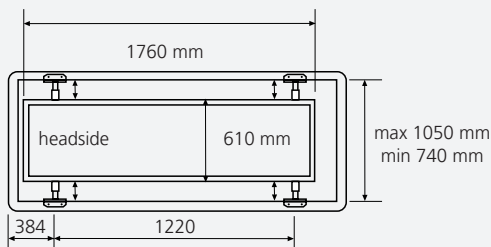

built-in position

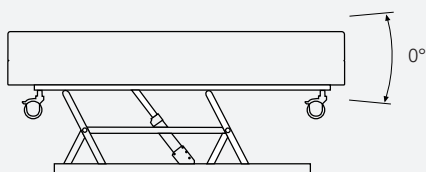

angles

2. THE MOTORISATION



FOR PART-LIST

Consult **page: 29 - ROW J**

Alternative actuators and handsets on request



integrated
SMPS



WORLDWIDE



<0.5W
STANDBY



HEAVY DUTY



OVERLOAD
PROTECTED



noiseless



self
lubricating



stability



wheels out
function

bedsize	width	art.n°
80-90	200-210-220	B100867

Partlist

A	Duomotion 4-fold 2M BI-mechanism	GTE articlenumbers: B200169, B200170, B200171, B200172, B200369	OKIN	REQUIRED							
				92558							
				Amount: 1							
				Set: Okimat 4 IPS-RF-Basic-6.5KN-74/69 stroke + RF remote Basic							
				Alternative actuators and handsets on request							

B	Duomotion 4-fold 2M BI-mechanism	GTE articlenumbers: B200520, B200521, B200522	OKIN	REQUIRED							
				92558							
				Amount: 1							
				Set: Okimat 4 IPS-RF-Basic-6.5KN-74/69 stroke + RF remote Basic							
				Alternative actuators and handsets on request							

C	Duomotion 5-fold 2M BI-mechanism	GTE articlenumbers: B200494, B200495, B200496, B200497, B200498	OKIN	REQUIRED							
				92558							
				Amount: 1							
				Set: Okimat 4 IPS-RF-Basic-6.5KN-74/69 stroke + RF remote Basic							
				Alternative actuators and handsets on request							

D	Duomotion 5-fold 2M BI-mechanism	GTE articlenumbers: B200577, B200578, B200058	OKIN	REQUIRED							
				92558							
				Amount: 1							
				Set: Okimat 4 IPS-RF-Basic-6.5KN-74/69 stroke + RF remote Basic							
				Alternative actuators and handsets on request							

E	technomotion 4-fold 3M BU-BI mechanism	GTE articlenumbers: B100892, B100893	OKIN	REQUIRED							
				86882	90469	91436	84929	85618	88699	78064	90354
				Amount: 1	Amount: 1	Amount: 1	Amount: 1	Amount: 1	Amount: 1	Amount	Amount: 1
				Deltadrive DS2/EPS/BK/280-100/L/6.0/24	Deltadrive DZ/EPS/BK/280-75/L/6.0/24	Deltadrive DZ/EPS/BK/280-60/L/6.0/24	HE150 control unit 3/4-mot	Adapter cable Deltadrive - HE150	Adapter cable LS-Molex PD15-HE150	Power Supply PD15WP/100(28/5.5)-240(28/5.5) /EU/IPX4/LS-F	Handset Style

F	Technomotion 4-fold 2M BU-BI-mechanism	GTE articlenumbers: B100920, B100921	OKIN	REQUIRED							
				86882	90469	78064	90411				
				Amount: 1	Amount: 1	Amount: 1	Amount: 1				
				Deltadrive DS2/EPS/BK/285-100/L/6.0/24	Deltadrive DZ/EPS/BK/280-75/L/6.0/24	Power Supply PD15WP/100(28/5.5)-240(28/5.5) /EU/IPX4/LS-F	Set: RF eco Basic				
				Alternative actuators and handsets on request							

G	Technomotion 5-fold 4M BU-BI-mechanism	GTE articlenumbers: B100875, B100876	OKIN	REQUIRED								
				86882	93718	93823	90469	84929	85618	88699	78064	93332
				Amount: 1	Amount: 1	Amount: 1	Amount: 1	Amount: 1	Amount: 1	Amount: 1	Amount: 1	Amount: 1
				Deltadrive DS2/EPS/BK/280-100/L/6.0/24	Deltadrive DZ/EPS/BK/333-45/L/3.0/24	Deltadrive DZ/EPS/BK/280-100/L/3.0/24	Deltadrive DZ/EPS/BK/280-75/L/6.0/24	HE150 control unit 4-mot	Adapter cable LS-Molex PD15-HE150	Adapter cable Deltadrive - HE150	Power Supply PD15WP/100(28/5.5)-240(28/5.5) /EU/IPX4/LS-F	RF remote Topline 4-mot
				Alternative actuators and handsets on request								



H	Lift mechanism 2x linear actuator (one module) GTE articlenumbers: B100914	OKIN	REQUIRED						
			91956	91956	84929	85618	88699	78064	92428
			Amount: 2	Amount: 1	Amount: 1	Amount: 1	Amount: 1	Amount: 1	Amount: 1
			Deltadrive DZ/ EPS/BK/380-130/L/6.0/24	Deltadrive DZ/ EPS/BK/380-130/L/6.0/24	HE150 control unit 4-mot	Adapter cable Deltadrive - HE150	Adapter cable LS-Molex PD15-HE150	Power Supply PD15WP/100 (28/5.5)-240(28/5.5)/EU/IPX4/LS-F	RF remote Topline lifter/ anti-trendelenburg
Option: to be combined with double actuator mechanism for adjustment back rest / foot rest									

I	Lift mechanism 2x linear actuator (two modules) GTE articlenumbers: B100825, B100826	OKIN	REQUIRED				
			86129	88118	92432	78064	88699
			Amount: 2	Amount: 1	Amount: 1	Amount: 1	Amount: 1
			Gammadrive GZ/ BK/280-100/F/4.0/24/ DIO/IP20/M/EXCL	HE300 control unit	RF remote Topline lifter	Power Supply PD15WP/ 100(28/5.5)-240(28/5.5)/EU/IPX4/LS-F	Adapter cable LS-Molex PD15-HE300

J	Lift mechanism 1x linear actuator GTE articlenumbers: B100867	OKIN	REQUIRED				
			90015	90023	92432	78064	88699
			Amount: 1	Amount: 1	Amount: 1	Amount: 1	Amount: 1
			Deltadrive DZ/BK/395-220/F/6.0/24	HE300 control unit	RF remote Topline lifter	Power Supply PD15WP/ 100(28/5.5)-240(28/5.5)/EU/IPX4/LS-F	Adapter cable HE300 - PD15
Option: to be combined with double actuator mechanism for adjustment back rest / foot rest							

K	Technomotion 5 fold slide back system GTE articlenumbers: B100916, B100917	OKIN	REQUIRED				
			93215	93217	78064	90411	
			Amount: 1	Amount: 1	Amount: 1	Amount: 1	
			Deltadrive DS1/EPS/BK/860-285/F/4.0/24/LS/D/IP20	Deltadrive DZ/BK/250-70/F/4.0/24/LS/IP20	Power Supply PD15WP/100 (28/5.5)-240(28/5.5)/EU/IPX4/LS-F	Set RF eco Basic	
Alternative actuators and handsets on request							

L	Split frame 4-fold 2M BU-BI (built-up / build-in) GTE articlenumbers: B100934, B100935	OKIN	REQUIRED				
			86882	93823	78064	90411	
			Amount: 1	Amount: 1	Amount: 1	Amount: 1	
			Deltadrive DS2/EPS/BK/280-100/L/6.0/24 ?	Deltadrive DZ/EPS/BK/280-100/L/3.0/24	Power Supply PD15WP/ 100(28/5.5)-240(28/5.5)/EU/IPX4/LS-F	Set RF eco Basic	
Alternative actuators and handsets on request							

Need further details?

Please contact Okin
 +49 (0)5223 979-0
 info@okin.de

Need further details?

Please contact GTE
 +32 51 33 64 30
 info@globaltec.be

Notes

A large grid of small dots for taking notes, consisting of 20 columns and 30 rows of dots.

Notes

A large grid of small dots, arranged in approximately 30 rows and 60 columns, intended for taking notes. The dots are evenly spaced and cover most of the page area below the title.



FOR TAILOR MADE BEDFRAMES,
NIGHTSTANDS, MATRASS BRAKES,
ETC. PLEASE CONTACT
GTE BELGIUM
HILLE-ZUID 10
8750 ZWEVEZELE

CONTACT US
+32 5133 64 30
info@GTE.be
www.gtebelgie.be



DEWERTOKIN GMBH
WESTSTRABE 1
32278 KIRCHLENGERN

CONTACT US
+ 49 2261 80 58 60
info@okin.de
www.dewertokin.de