

SEATING SYSTEMS

Better Components, Better Furniture



One-stop Solution for Motion Furniture

Our customers success is our success

Close cooperation and quick communication to provide customers with expert consulting sales service. Focusing on customer needs, we provide professional product services and one-stop solutions for motion furniture.



SERVICE AROUND THE WORLD

OKIN has locations in 27 countries and regions around the world, to provide more localized services to customers worldwide.



Approved by authoritative certification institutions



System Solutions for Smart Seating

Manual recliner system

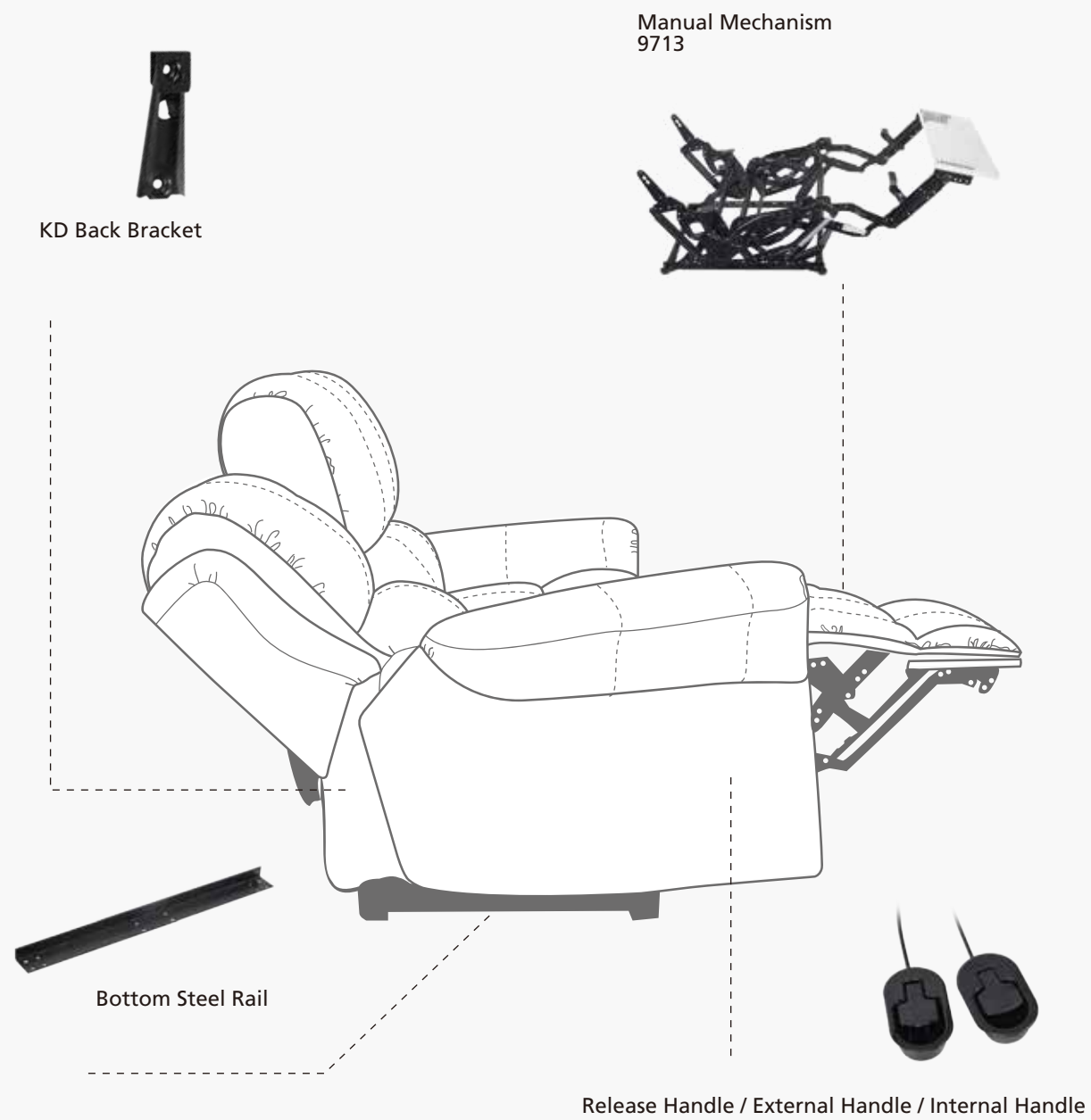

Power recliner system

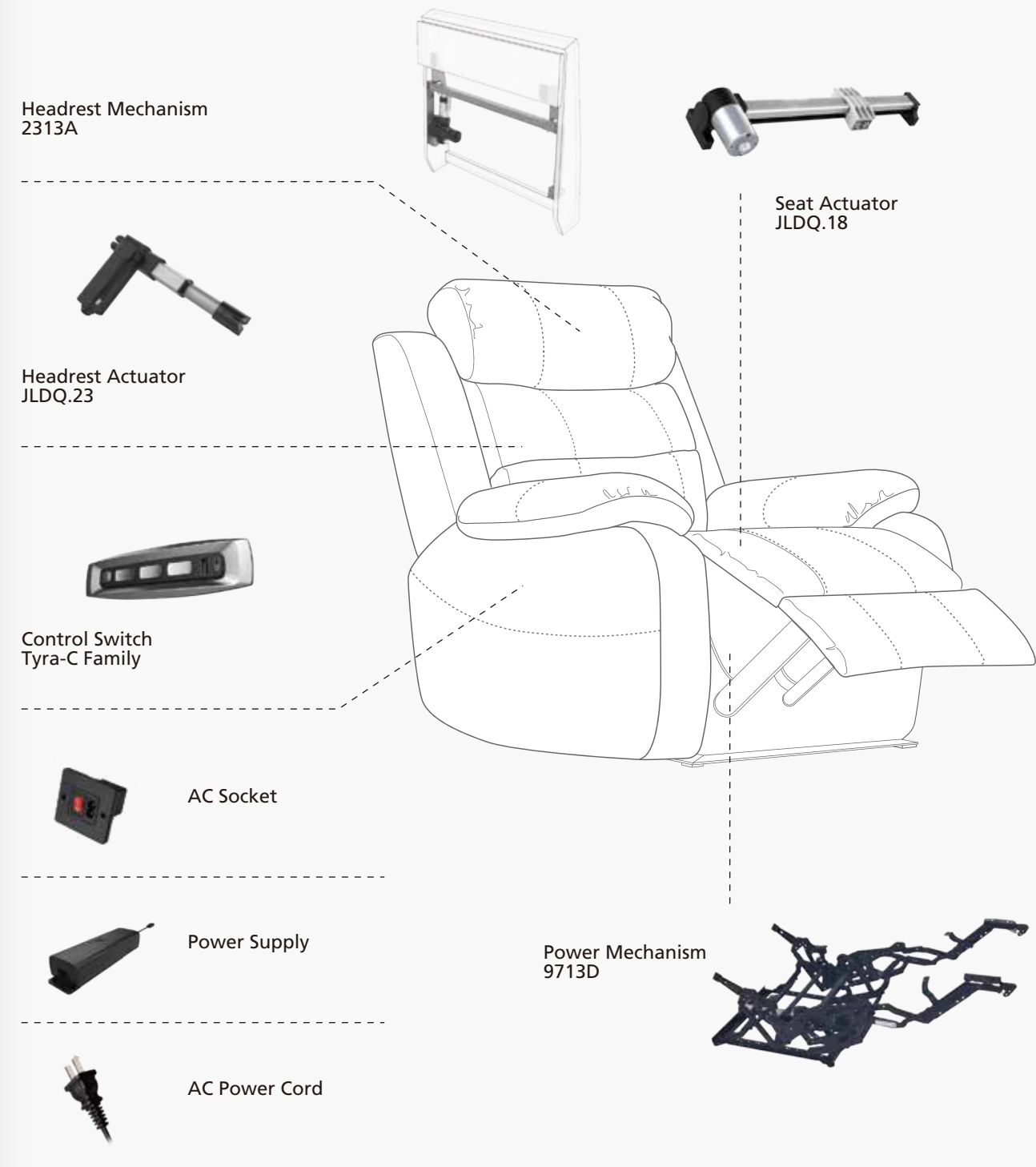

Mechatronics®

9718DX (Power)

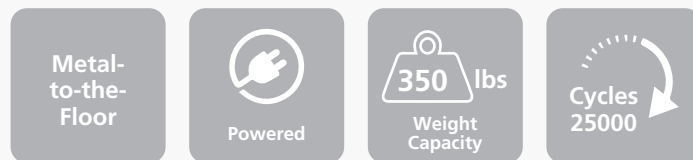

1. The innovative design of Mechatronics® is integrated on the basis of metal-to-the-floor mechanism
2. Wood frame interchangeable with Rocker/Glider/Lift Chair series
3. Large diameter crossbar and long-lasting rivet joints
4. KD back brackets allow easy back removal for handling and transportation
5. Available in different seat width sizes

Application:

Single



Loveseat



Sofa



Sectional

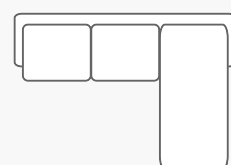

2528 (Headrest & Lumbar)



1. Actuators all mounted at the center of back for a steady movement
2. Integrated headrest and lumbar for easy assembly
3. Headrest (2320) or Lumbar (2820) can be used individually
4. Available in different seat widths and adjustment angles

JLDQ.25

Drive for headrest and lumbar adjustment



JLDQ.26

Drive for the seat position adjustment



Measured!
15%
Saved Installation Time

Savings!
↓
Reduced cost Material Breakthrough

Compatible!
80%
Can replace Metal-to-Floor Mechanisms

Metal-to-the-Floor

9001D True Zero Wall (Power)



1. The backrest leans completely against the wall, with zero distance
2. Unique backrest design prevents clothes from pulling and provides better lumbar support
3. Ingenious patented design to prevent the deformation
4. Large diameter crossbar and long-lasting rivet joints
5. KD back brackets allow easy back removal for handling and transportation
6. Available in standard and custom sizes

Application:

Single



Loveseat



Sofa



Sectional

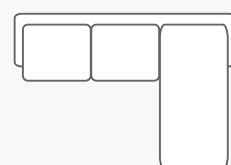

9011DN Zero Gravity (Power)

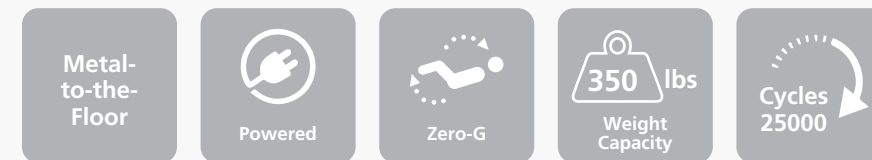

1. Zero Gravity position simulates the absence of gravity in the space
2. The legs are slightly higher than the heart to reduce the pressure on the body and achieve extreme comfort
3. Large diameter crossbar and long-lasting rivet joints
4. KD back brackets allow easy back removal for handling and transportation
5. Available in standard and custom sizes

Application:

Single



Loveseat



Sofa



Sectional

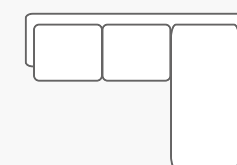

**9713 / 9713D (Manual / Power)
9713DX Quick-install (Power)**

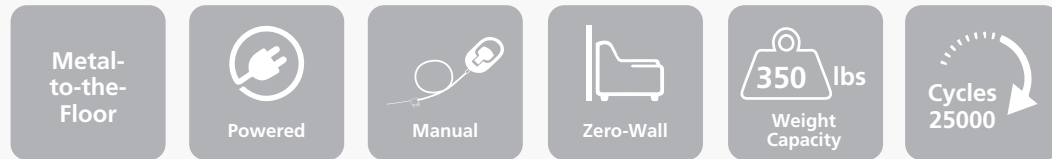

1. 9713 (Manual) and 9713D (Power) versions with standard installation processes
2. 9713DX Quick installation design, higher efficiency
3. Ingenious patented design to prevent the deformation
4. Wood frame interchangeable with Rocker/Glider/Lift Chair series
5. Large diameter crossbar and long-lasting rivet joints
6. KD back brackets allow easy back removal for handling and transportation
7. Available in standard and custom sizes

Application:

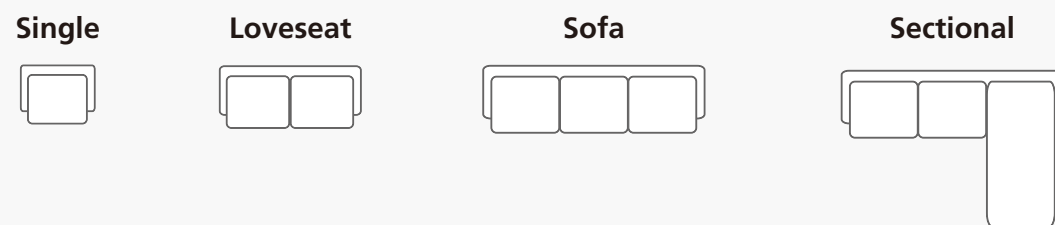

9145D Low-Seat True Zero-wall (Power)



1. The backrest leans completely against the wall, with Zero distance
2. Unique backrest design prevents clothes from pulling and provides better lumbar support
3. Seat height compression design, reduced by 50mm
4. Large diameter crossbar and long-lasting rivet joints
5. KD back brackets allow easy back removal for handling and transportation
6. Available in standard and custom sizes

Application:

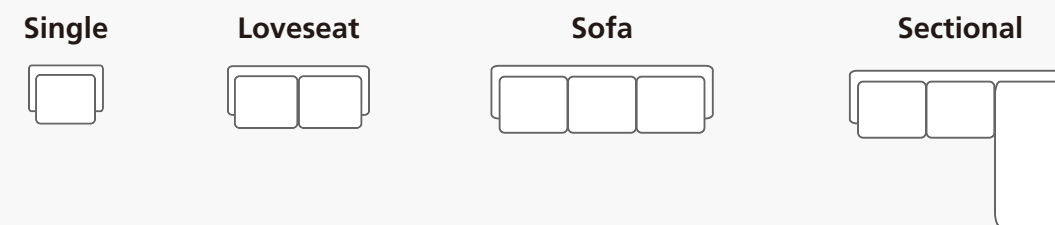

905 / 906 Rocker (Manual)



1. Ingenious patented design to prevent the deformation
2. Wood frame interchangeable with Zero-wall/Glider/Lift Chair series
3. Large diameter crossbar and long-lasting rivet joints
4. KD back brackets allow easy back removal for handling and transportation
5. Cable / Handle / Lever available as activating options
6. Available in 7 standard and custom sizes

Application:

Single



Loveseat



Sofa



Sectional



907 / 908 Glider (Manual)

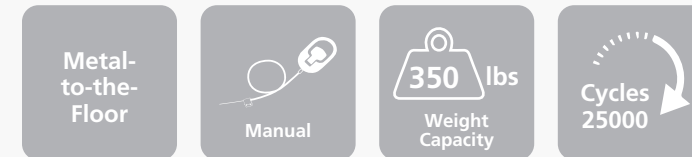

1. Ingenious patented design to prevent the deformation
2. Wood frame interchangeable with Zero-wall/Rocker/Lift Chair series
3. Large diameter crossbar and long-lasting rivet joints
4. KD back brackets allow easy back removal for handling and transportation
5. Cable / Handle / Lever available as activating options
6. Available in 7 standard and custom sizes

Application:

Single



Loveseat



Sofa



Sectional

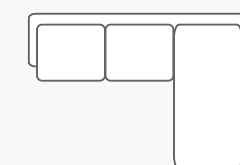

Wood-to-the-Floor

5216D / 5217D Zero Gravity (Power)



1. High-leg (5216D) and Low-leg (5217D) Zero Gravity recliners
2. Zero Gravity position simulates the absence of gravity in the space
3. The legs are slightly higher than the heart to reduce the pressure on the body and achieve extreme comfort
4. New linkage drive design provides a stable and smooth movement
5. KD back brackets allow easy back removal for handling and transportation
6. Available in standard and custom sizes

Application:

Single



Loveseat



Sofa



Sectional



5810D High-leg (Power)

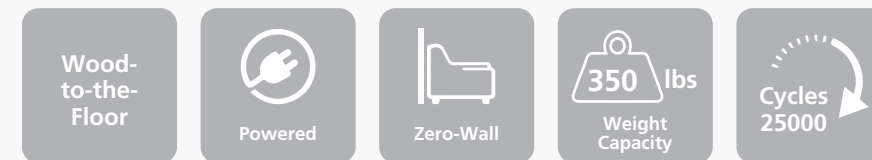

1. Suitable for low seat high-leg armchairs and sofas
2. Seat height compression and seat depth increase design
3. New linkage drive design provides a stable and smooth movement
4. KD back brackets allow easy back removal for handling and transportation
5. Available in standard and custom sizes

Application:

Single



Loveseat



Sofa



Sectional

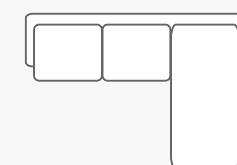

5368 / 5368D Low-leg (Manual / Power)

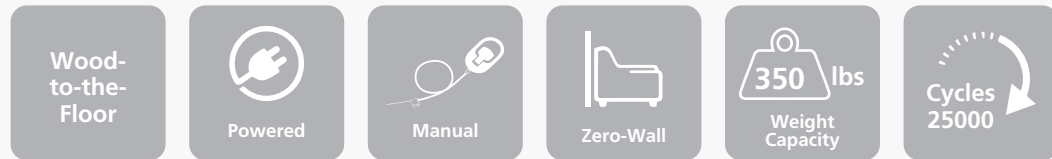

1. Suitable for low-leg armchairs and sofas
2. Manual (5368) or Power (5368D) versions available
3. Spring loaded footrest enhances safety throughout the movement.
4. New linkage drive design provides a stable and smooth movement
5. KD back brackets allow easy back removal for handling and transportation
6. Available in standard and custom sizes

Application:

Single



Loveseat



Sofa



Sectional



5198D High-leg True Zero Wall (Power)



1. Suitable for high-leg armchairs and sofas
2. The backrest leans completely against the wall, with zero distance
3. Unique backrest design prevents clothes from pulling and provides better lumbar support
4. New linkage drive design provides a stable and smooth movement
5. KD back brackets allow easy back removal for handling and transportation
6. Available in standard and custom sizes

Application:

Single



Loveseat



Sofa



Sectional

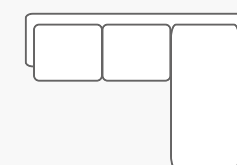

516DN High-leg (Power)



- 1. Suitable for high-leg armchairs and sofas
- 2. Compressed design for lower seat height
- 3. New linkage drive design provides a stable and smooth movement
- 4. KD back brackets allow easy back removal for handling and transportation
- 5. Available in standard and custom sizes

Application:

Single



Loveseat



Sofa



Sectional



517D Low-leg (Power)



- 1. Suitable for low-leg armchairs and sofas
- 2. Compressed design for lower seat height
- 3. New linkage drive design provides a stable and smooth movement
- 4. KD back brackets allow easy back removal for handling and transportation
- 5. Available in standard and custom sizes

Application:

Single



Loveseat



Sofa



Sectional

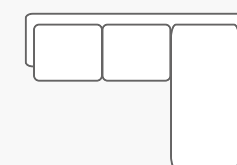

512D (Power)

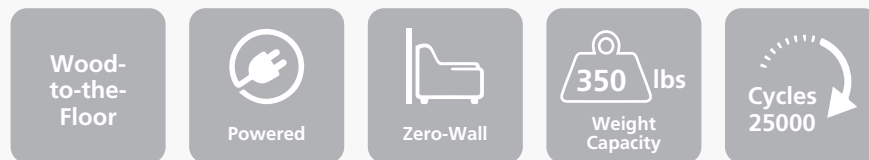

1. Suitable for low-leg armchairs and sofas
2. Footrest extension for fixed seat and backrest designs
3. New linkage drive design provides a stable and smooth movement
4. To ease transportation, KD back brackets can be added as an optional
5. Available in standard and custom sizes

Application:

Single



Loveseat



Sofa



Sectional

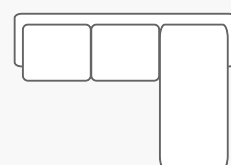

7550 (Manual)



1. Push the armrest and lean back to open
2. Self-balancing design, the backrest can be stopped at any position
3. High-leg design
4. Footrest extension for more comfortable leg support
5. KD back brackets allow easy back removal for handling and transportation

Lift Chair

6111D



1. Single motor system
2. Smooth lifting process
3. Wood frame interchangeable with Zero-wall/Rocker/Glider series
4. KD back brackets allow easy back removal for handling and transportation
5. Available in sizes 0/-1/-2/-3/-4

6311D



1. Dual-motor system
2. Independent backrest design, close to lay-flat when fully reclined
3. Wood frame interchangeable with Zero-wall/Rocker/Glider series
4. KD back brackets allow easy back removal for handling and transportation
5. Available in sizes 0/-1/-2/-3/-4
6. Optional version with casters (6511D), easy to move

Relax Chair

3021D / 3031D (Power)



1. Dual-motor (3021D) and three-motors (3031D) systems
2. Manual (3021D) or power (3031D) headrest
3. Higher and longer leg support
4. Back, arm and base options available

3101 (Manual)

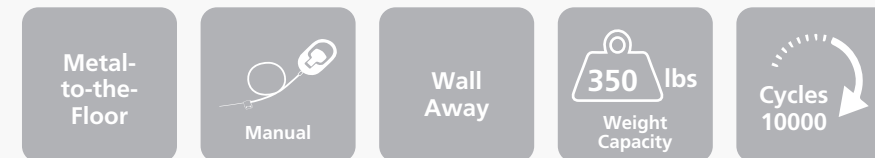

1. 360° swivel movement
2. Pneumatic control, the backrest can be paused at any position
3. KD armrest brackets option, to ease handling and transportation
4. Higher lumbar support thanks to a higher backrest connection to the seat cushion
5. Unique backrest design prevents clothes from pulling and provides better lumbar support

Headrest & Lumbar

1101 (Headrest)

1. Increased stability with center drive
2. Wide angle rotation for extra headrest tilt
3. Anti-pinch design
4. Allows very slim backrest design
5. Available in different width sizes



2313A (Headrest)

1. Economical design, one-side drive
2. Reinforced crossbar optional
3. Wide angle headrest
4. Anti-pinch design
5. Available in different width sizes

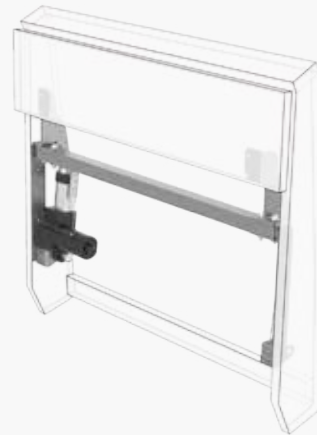

2316A (Headrest)

1. Increased stability with center drive
2. Anti-pinch design
3. All visible parts are chrome-plated
4. Headrest height raised
5. Available in different width sizes



2812 (Lumbar)

1. Increased stability with center drive
2. Allows very slim backrest design
3. Simple design, easy to install
4. Lumbar support stroke: 65mm Max
5. Available in different width sizes



2523B (Headrest & Lumbar)

1. Headrest (2314) & Lumbar (2812) split design
2. Increased stability with center drives
3. Allows very slim backrest design
4. Simple design, easy to install
5. Available in different width sizes



1401 / 1501 (Headrest & Lumbar)

1. Integrated dual-motor headrest and lumbar system
2. Increased stability with center drives
3. Wide angle rotation for extra headrest tilt
4. Anti-pinch design
5. Available in different width sizes
6. Headrest bracket regular (1501) and extended (1401) versions

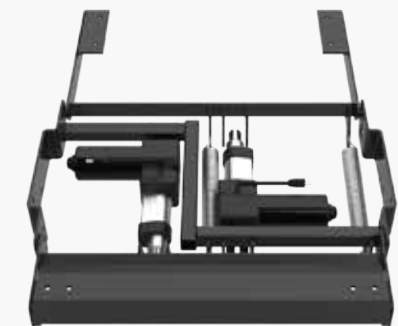

Actuators

JLDQ.18



Input voltage	29V DC
Max. Load Capacity	3000N (Push) / 2000N (Pull)
Stroke	20 - 500mm
Min. install size	≥ Stroke + 115mm
Duty cycle	1 min on / 8 min off

JLDQ.27



Input voltage	29V DC
Max. Load Capacity	6000N (Push) / 3000N (Pull)
Stroke	20-500 mm
Min. install size	≥ Stroke + 138 mm
Duty cycle	1 min on / 8 min off

JLDQ.23



Input voltage	29V DC
Max. Load Capacity	2500N (Push) / 1500N (Pull)
Stroke	20 - 300mm
Min. install size	≥ Stroke + 100mm
Duty cycle	1 min on / 8 min off

JLDQ.20



Input voltage	29V DC
Max. Load Capacity	4000N (Push) / 2000N (Pull)
Stroke	20 - 400mm
Min. install size	≥ Stroke + 130mm
Duty cycle	1 min on / 8 min off

JLDQ.19B



Input voltage	29V DC
Max. Load Capacity	4000N (Push) / 3000N (Pull)
Stroke	20 - 500mm
Min. install size	≥ Stroke + 150mm
Duty cycle	1 min on / 8 min off

JLDQ.19



Input voltage	29V DC
Max. Load Capacity	6000N (Push) / 3000N (Pull)
Stroke	20 - 350mm
Min. install size	≥ Stroke + 150mm
Duty cycle	1 min on / 8 min off



**A World
in Motion**

Powered by **OKIN**

Handsets

Air massage handset

**Atlas-Air
HS.10**



Material	Plastic
Colors	Black / Customizable
Buttons	9 buttons
Functions	2 motors / USB-A / Heating pad / Air massage / Home

**Dinghy-Air
HS.16**



Material	Plastic
Colors	Black / Customizable
Buttons	9 buttons
Functions	2 motors / USB-A / Heating pad / Air massage / Indicator light / Home

**Atlas Family
JLDK.38/HS.10**

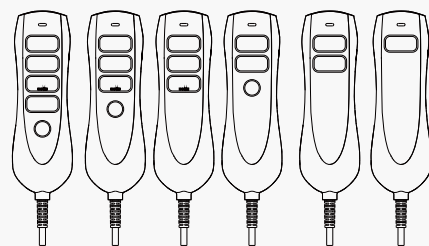

Material	Plastic
Colors	Black / Silver / White / Customizable
Buttons	2 / 4 / 5 / 6 / 7 / 9 buttons
Functions	Up to 3 motors / USB-A / Backlight / Home

**Anton Family
HS.12**



Material	Plastic
Colors	Black / Customizable
Buttons	2 / 4 buttons
Functions	1-2 motors / Backlight

**Avatar Family
HS.13**



Material	Plastic
Colors	Black White / Customizable
Buttons	2 / 3 / 4 / 5 / 6 / 7 buttons
Functions	Up to 3 motors / Backlight / Hook / Home

**SP-Line Family
HS.14**

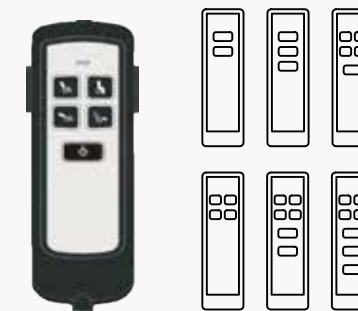

Material	Plastic
Colors	Black / Customizable
Buttons	2 / 3 / 4 / 5 / 6 / 7 buttons
Functions	Up to 3 motors / Backlight / Hook / Home

**Pebble Family
HS.22**



Material	Plastic
Colors	Black / Customizable
Buttons	2 / 4 / 6 / 8 buttons
Functions	1-3 motors / USB-A / Backlight / Hook / Home

Switches

Ridge Family

JLDK.55.02



JLDK.55.05



JLDK.55.07



Material	Plastic
Colors	Silver / Champagne / Customizable
Buttons	2 / 5 / 7 buttons
Functions	Up to 3 motors / Home / USB-A 10W

Ridge-C Family

FS.04.02



FS.04.05



FS.04.07



Material	Plastic
Colors	Silver / Champagne / Customizable
Buttons	2 / 5 / 7 buttons
Functions	Up to 3 motors / Home / USB-A + C 10W / 15W / 18W

Infinite Family

JLDK.54.05



Backlight version

JLDK.54.07



Backlight version

FS.17.05



Backlight version

Material	Plastic
Colors	Champagne / Customizable
Buttons	2 / 5 / 7 buttons
Functions	2-3 motors / Backlight / Home / USB-A 10W / USB-A + C 10W

Tyra-C Family

FS.03.02



FS.03.05



FS.03.07



Material	Plastic
Colors	Silver / Champagne / Customizable
Buttons	2 / 5 / 7 buttons
Functions	Up to 3 motors / Backlight / Home / USB-A + C 10W / 15W / 18W

Solo Family

JLDK.64.02



JLDK.64.04



Material	Plastic
Colors	Black
Buttons	2 / 4 buttons
Functions	Up to 2 motors / Hidden switch

Como Family

JLDK.15.08



JLDK.15.08



JLDK.15.08



Material	Plastic
Colors	Silver / Gray / Customizable
Buttons	2 / 5 / 7 buttons
Functions	Up to 3 motors / Home / Light / USB-A 10W

Leon-M Family

JLDK.48.07



JLDK.48.09



JLDK.48.07



Material	Plastic
Colors	Silver / Customizable
Buttons	5 / 7 / 9 buttons
Functions	2-3 motors / Home / Memory / Heating pad / USB-A 10W

Como-C Family

FS.16.02



FS.16.04



FS.12.06



Material	Plastic
Colors	Silver / Gray / Customizable
Buttons	2 / 4 / 6 buttons
Functions	Up to 3 motors / Home / Light / USB-A + C 10W / 15W / 18W

More Optional Power Switches

JLDK.17.04



JLDK.17.04



JLDK.15.05



JLDK.48.05



JLDK.48.07



JLDK.15.07



JLDK.17.03



JLDK.17.05



JLDK.17.05



JLDK.15.02



JLDK.04.07



JLDK.24.02



JLDK.08.03



JLDK.24.01



JLDK.07.03



JLDK.07.01



JLDK.07.02



JLDK.04.06



Accessories

Power Supply

Wall Plug Power Adapter PW.10



Input	100-240V AC 50Hz-60Hz 2.5A
Output	29V DC 1.5A/1.8A/2.0A
Plug	US, EU standards
Certificates	UL/FCC/IC/DOE/CEC/RoHS/CE/ERP/RoHS
Features	Overcurrent, overvoltage, overheating and short circuit protection

Desktop Power Adapter PW.20



Input	100-240V AC 50HZ-60Hz 2.5A
Output	29V DC 1.8A/2.0A/3.0A
Plug	CHN, US, JP, EU, KOR, UK, AUS standards
Certificates	CCC/UL/FCC/IC/DOE/CEC/CB/CE/UKCA/PSE/KC+KCC/SAA+RCM/ERP/MEPS/RoHS
Features	Overcurrent, overvoltage, overheating and short circuit protection

Desktop Power Adapter PW.30



Back up battery compartment
(2*9V batteries)

Input	100-240V AC 50Hz-60Hz 2.5A
Output	29V DC 1.8A/2.0A
Plug	CHN, US, J P, EU, KOR, UK, AUS standards
Certificates	CCC/UL/FCC/IC/DOE/CEC/CB/CE/UKCA/PSE/KC+KCC/SAA+RCM/ERP/MEPS/RoHS
Features	Overcurrent, overvoltage, overheating and short circuit protection



Power Pack

JLDP.11.011.000



 Lithium Battery

Technical parameters

Nominal voltage	DC 25.9V
Nominal capacity	1800mAh
Nominal output	20-29.4V 5A Max
Overload current	6.0A Max
Charging parameters	
Input voltage	30V Max
Input current	3A Max
Environment	
Work temp.	0~30°C
Storage temp.	0~45°C
Humidity	20%~85%

JLDP.11.012.000



Technical parameters

Nominal voltage	DC 25.2V
Nominal capacity	2550mAh
Nominal output	16.8-29V 5A Max
Overload current	14A Max
Charging parameters	
Input voltage	30V Max
Input current	3A Max
Environment	
Work temp.	0~40°C
Storage temp.	0~55°C
Humidity	20%~85%

Multi-Function Cupholder

 Motor Control

 Cooling Cupholder

 Ambient Light

 USB Charger

 Wireless Charger

 Phone Holder

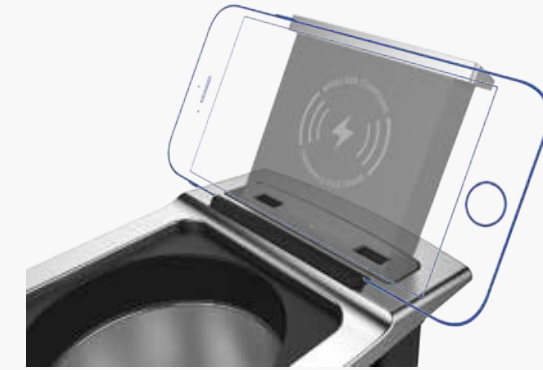

Matching Control Box
JLDP.05.117.001



Cupholder
JLDP.57.09.01



Wireless Charger

JLDP.22



1. Power: 5W /10W (match with different phone protocols)
2. Color of panel: Black

Wireless Charging Table

JLDK.56

Power Drive Armrest

1. Power: 10W / 15W
2. Panel color: Black / Silver / Wood grain
3. The regular console can be upgraded to a power console, and use a hidden cupholder for a tidier and cleaner look



Double-face Cupholder

JLDP.14.028



The cupholder is composed of the foundation and the inner holder. One of the sides is designed to hold plain containers like bottles, cans or glasses. Turning it to the other side, it can hold vessels with handles like mugs and tea and coffee cups. Also, an elegant and functional backlight can be added as optional.

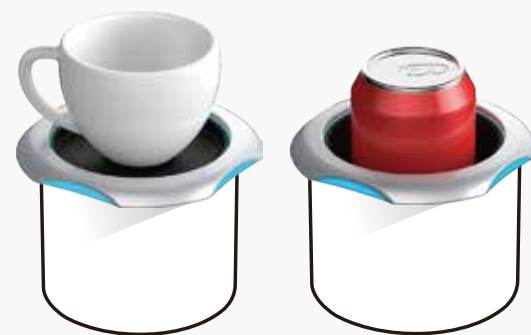

Multi-Function Armrest Box

Power Armrest
LH.2111

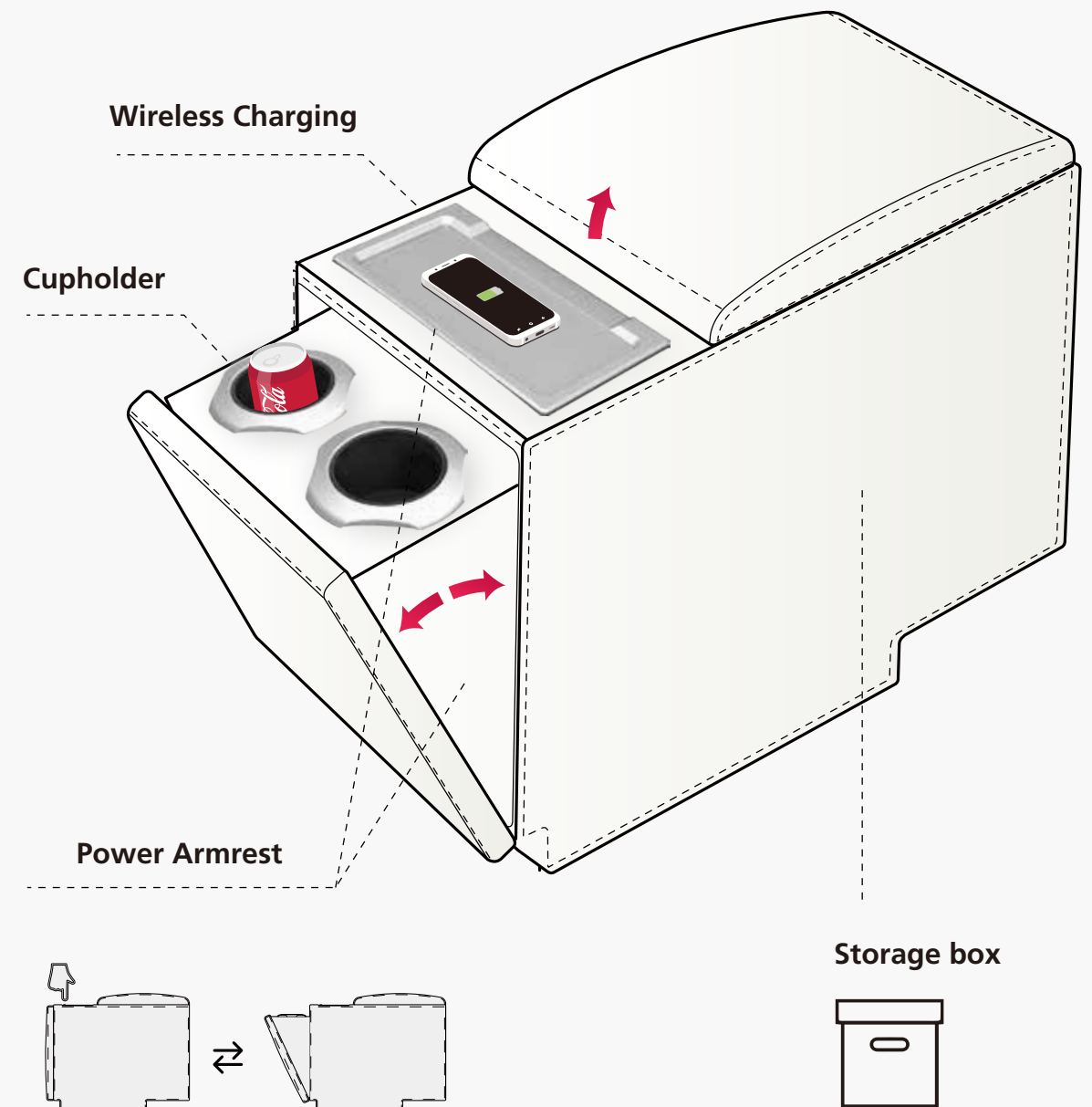

Remote Control

**RF LITE
RF.23**



**Spaceship
JLDK.21**



Material	Plastic	Plastic
Colors	Black	White
Buttons	6 buttons	2 buttons
Functions	2 motors / Flat / 2.4G	1 motor / 2.4G / Light

AC/DC Socket

JLDP.14.032

AC Socket



DC Socket



DC Socket



Input	AC 100V-240V	DC 29V	DC 29V
	On / Off Buttons	Indicator light	On / Off Buttons

Fast Connection Port

R5.233.01.017



Light Strip

R5.133.00.XXX



Input: 12V / 29V
Colors: Blue / Custom

Anti-pinch Sensor

JLDK.11.02



Material: Rubber
Clamp force: >15N

USB Port

JLDP.14.027



PO.02.02



PO.11.01



**PO.13.01
Type-C**



Input	5V	29V	29V	29V
Output	5V / 2A	5V / 2A	10W / 18W	10W / 18W
Colors	Black	Black / Silver	Black / Silver	Silver

* Overcurrent, overvoltage and overheating protection

System Solutions

Air Massage System

1. Manual / Automatic mode
2. Timed automatic shutdown
3. Silent inflation & deflation
4. Simulates the real hand feeling
5. Customizable

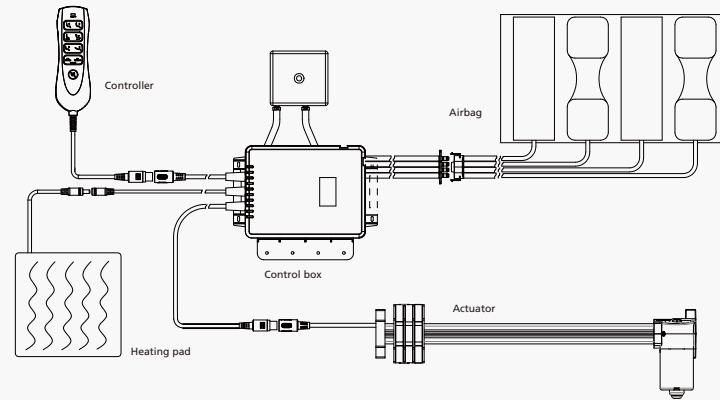

Airbag (FP.17.01) Control Box (CB.16.24)
Heating Pad (R5.229.01) Controller (HS.10/HS.16)

Bluetooth Control System

1. Bluetooth 4.2 technology: lower power consumption, less radiation and faster response time
2. Multiple memory positions
3. Smartphones and tablets compatible, user-friendly and intuitive app, customizable interface



Scan to download



Scan to download



Bluetooth Box (JLDP.05.065)

Offline Voice Control System

1. Easy to install: only needs power on, no network connection needed
2. The system is highly customized, to better meet the customer needs
3. Customizable activation methods: voice (customized key words) and key
4. Voice feedback
5. Fast response and high speech recognition accuracy
6. English and Chinese languages available



Offline Voice Control Box (JLDK.72)

Multi-function Control System

1. Motor / Light strip / Heating pad / Memory optionals
2. Wireless charger: 10W
3. USB A+C: 10W
4. Can be linked to the smartphone to access and control the playlist directly from the Smart Table
5. Customizable



Smart Table (JLDK.68)
Bluetooth Audio (FP.06)

OKIN Global Service

China / Jiaxing

Add: No. 1507, Taoyuan Road, Gaozhao Street, Xiuzhou District,
Jiaxing City, Zhejiang Province
Service Hotline: +86-400-887-8573
Tel: +86-(0)573-8228-1028
E-mail: sales@dewertokin-technology.com
Web: www.dewertokintechnology.com

China / Huizhou

Add: Dongfeng Car City Storage & Logistics Distribution Center,
5#, Longsheng Road No.2, Xinliao, Daya Bay District,
Huizhou, Guangdong
Tel: +86-(0)755-8921-7192
E-mail: seatingsales1@refinedchina.com

China / Taiwan

Phoenix Mecano Hong Kong Limited Taiwan Branch
Add: Room 4E-12, No.5, Hsin-Yi Road, Sec. 5, 11011
Taipei, Taiwan
Contact: Allen Wang/Sales Manager
Phone: +886 2 27252582
E-mail: allen@pmtwn.com.tw

Vietnam

Lo H5-2(khu B1), duong D9, khu cong nghiep rach bap, xa an dien,
thi xa ben cat, tinh binh duong, Vietnam
Contacts: Josiah Xia
Mobile: +84 0913922780
Email: Josiah.Xia@dewertokin-technology.com

Germany

DewertOkin GmbH
Weststrasse 1
32278 Kirchlengern
Deutschland/ Germany
Tel: +49 5223 979 0
Fax: +49 5223 751 82
E-mail: info@dewertokin.de
Web: http://www.dewertokin.com

Australia

Add: 64 Butler way, Tullamarine, Victoria, Australia, 3043
Tel: +61 (3) 9338 56 99
Fax: +61 (3) 9338 53 99
E-mail: info@phoenix-mecano.com.au
Web: www.phoenix-mecano.com.au

Korea

Add: No. 506, Bomb Building, 617-3, Gajeong-dong, Seo-gu,
Incheon, Korea.
Zip Code: 22731
Contact: Amos An
Mobile: +82-10-6865-0599
E-mail: amos.an@dewertokin-technology.com

Japan

Add: 52 Saiwai-Cho 420-0067 Shizuoka-City
Contact: JR Piao - Sales Manager
Mobile: +81-90-6507-0205
E-mail: jr.piao@dewertokin-technology.com
Web: https://www.dewertokin.com/ja/

Malaysia / India

Singapore / Thailand

Indonesia

Add: No. 22A-1, Blok 22A, Level1, Empire Galleri,
Jalan Empayar/KU1 off Persiaran Sultan Ibrahim,
41150 Klang, Selangor, Malaysia
Zip Code: 41150
Contact: Ngkian Seng
Mobile: +60 193150628
E-mail: ngkianseng@dewertokin-technology.com

United States

Okin America INC.
Add: 291 CDF Blvd Shannon, MS 38868
Contact: Mike Pequignot
Tel: +1 662-200-7027
E-mail: mike.pequignot@okinamerica.com
Web: www.okinamerica.com

Brazil

DewertOkin Latin America
Address: Av. Prof. Alceu Maynard de Araujo, 185, São Paulo, SP
Zip Code: 04626-160
Contact: Mrs. Adriana Shinzato - Sales coordinator
E-mail: vendas@dewertokin.com.br
Tel: +55.11.56434190
Web: www.dewertokin.com.br

