



MEGAMAT FBR

Installation Instructions

(Translation of the original installation instructions)

Foreword

Document revision history

Version	Date	Modification, change
(-)	10/2015	First release
1.0	04/2020	Declaration of incorporation, declaration of conformity, ratings plate, disposal

Disclaimer and exclusion of liability

DewertOkin is not responsible for damage resulting from:

- failure to observe these instructions,
- changes made to this product which have not been approved by DewertOkin, or
- the use of replacement parts which have not been approved or manufactured by DewertOkin.

Manufacturer's address

DewertOkin GmbH
 Weststrasse 1
 32278 Kirchlengern,
 Germany
 Tel: +49 (0)5223/979-0
 Fax.: +49 (0)5223/75182
<http://www.dewertokin.de>
Info@dewertokin.de

Creation of a complete operating instruction manual for the entire end product

These instructions are only intended to be used by the end-product manufacturer. They should not be given to the operator of the end product. The factual information contained within may be used as a basis when creating the end-product manual.

The warning and danger notices are best suited for use in the end product's manual. However, it is not sufficient to simply follow these notices. You should also carry out an internal risk assessment for your end product. This can then be used as the basis for the safety notices in your manual.

These installation instructions do not contain all information required to safely operate the end product. They only describe the installation and operation of the drive as partially completed machinery.

The instructions are intended for the technicians responsible for manufacturing an end product and not for the operators of the end product.

Notice for customers in EU nations**German Inspection Authority (TÜV SÜD Product Service) testing label**

The construction of the MEGAMAT FBR drive has been inspected by the German TÜV SÜD Product Service Inspection Authority. TÜV SÜD Product Service also monitors the production of the MEGAMAT FBR. The official German TÜV SÜD Product Service certifies this construction inspection and production monitoring.

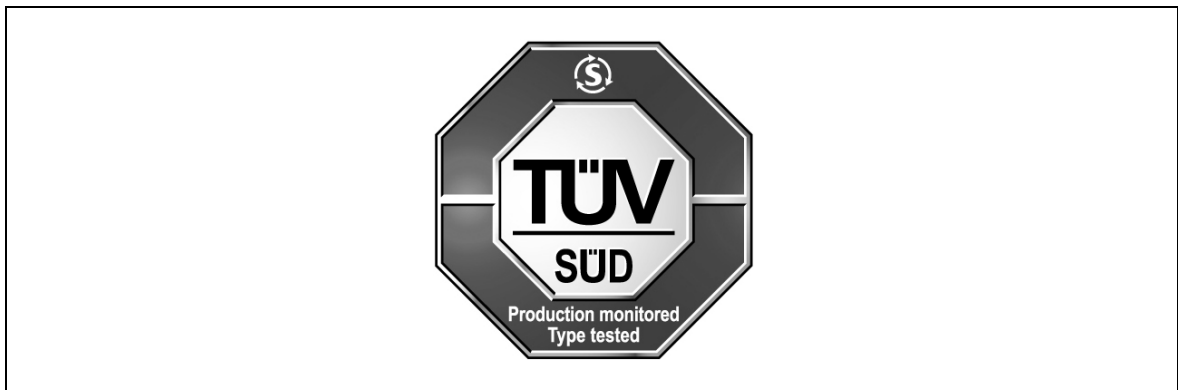

Figure 1 TÜV SÜD Product Service Safety Mark

Table of Contents

Foreword	3
Document revision history	3
Disclaimer and exclusion of liability	3
Manufacturer's address	3
Creation of a complete operating instruction manual for the entire end product	3
Notice for customers in EU nations	4
Table of Contents	5
1. General Information	7
1.1 About these installation instructions	7
1.2 Availability of this document	7
1.3 Conventions used	7
2. Safety notices	8
2.1 Proper and intended usage	8
2.2 Safety notices within the installation instruction and the operating instructions for the entire machine	9
2.3 Selection and qualification of personnel	9
2.4 Notice on safety during operations	9
2.5 Product identification	10
3. Possible combinations	11
4. Description	12
4.1 Components	12
5. Technical specifications	13
6. Installation	14
6.1 Safety notices to observe during installation	14
6.2 Installation procedure	15
7. Operating notes	18
7.1 General information	18
8. Troubleshooting	20
9. Maintenance	21
9.1 Maintenance	21
9.2 Cleaning and care	21
82715 1.0	5



10.	Disposal	22
10.1	Packaging material	22
10.2	Drive components	22
	Declaration of incorporation/installation	23
	EU Declaration of Conformity	24
	Additional information	25

1. General Information

1.1 About these installation instructions

These installation instructions must be followed closely in order to install this drive successfully and safely in the end product. These instructions are not an operating manual for the end product.

These instructions will help you to minimize danger, repair costs and down times. They will also help you to maximize the reliability and lifespan of the end product.

	 CAUTION
	<p>The notices in these instructions must be followed! Following the guidelines during installation and connection procedures will help to minimize:</p> <ul style="list-style-type: none"> • the risk of accident and injury, and • damage to the drive system or the end product.

These installation instructions have been written with due care and attention. However, we cannot guarantee that the data, images and drawings are complete and correct nor do we accept any liability for the information contained therein, unless required by law.

- ▶ We reserve the right to make unannounced technical changes in the course of our continual product improvement process!

1.2 Availability of this document



As manufacturer of the end product, you are obligated to comply with Machinery Directive 2006/42/EC. This directive stipulates that the installation instructions must be kept on file for governmental inspection purposes.



1.3 Conventions used

Notices which do not relate to safety are indicated in these instructions with a triangle:

- ▶ Triangular notice symbol

Safety notice explanations

	 WARNING
	<p>WARNING indicates a hazardous situation which, if not avoided, <i>could</i> result in death or serious injury.</p>

	 CAUTION
	<p>CAUTION indicates a hazardous situation which, if not avoided, could result in minor or moderate injury.</p>



	NOTICE
	<p>NOTICE is used to address practices which are not related to personal injury but may result in damage to the product or surroundings.</p>

2. Safety notices

2.1 Proper and intended usage



The MEGAMAT FBR drive is meant to be installed in an end product.



- It provides motor adjustment capabilities for movable furniture. It should be used in conjunction with suitable fittings and mechanics.
- It can be used for care purposes (CARE).
- It can be used in a hospital (HOSP).
- It can be used for furniture applications (in beds, reclining chairs, etc.).

	 CAUTION
	<p>This drive should only be used for the applications described above. Any other use is forbidden. Improper usage can lead to accidents or destruction of the unit. Such non-approved applications will lead immediately to the expiration of all guarantee and warranty claims on the part of the end-product manufacturer against the manufacturer.</p>

Improper usage

Be sure to follow the notices below concerning improper usage. You should include them in your product manual in order to inform the users of your end product.

	 WARNING
	<p>The MEGAMAT FBR drive should not be used:</p> <ul style="list-style-type: none"> • in any environment where combustible or explosive gases or vapours (e.g., anaesthesiology) may be present, • in a moist environment, • outdoors, • in any application that will be cleaned with an automated washing system.

	 CAUTION
	<p>The MEGAMAT FBR drive may not be operated:</p> <ul style="list-style-type: none"> • by small children, • by frail or infirm persons without supervision, or • in the proximity of small children.

The MEGAMAT FBR drive can be used by children of 8 years and older, persons with reduced physical, sensory or mental capabilities, or persons with lack of experience or knowledge when they are supervised or instructed concerning the safe use of the device and when they understand the resulting risks. Do not allow children to play with this device. The cleaning and user maintenance must not be carried out by children without supervision.

You should only use spare parts which have been manufactured or approved by DewertOkin. Only these parts will guarantee a sufficient level of safety.

2.2 Safety notices within the installation instruction and the operating instructions for the entire machine

The manufacturer of the end product is only permitted to operate the MEGAMAT FBR drive (by itself an incomplete machine)

- when the end product (for which the MEGAMAT FBR drive is intended) is in compliance with all protective measures specified in the Machinery Directive 2006/42/EC, and
- when the manufacturer expressly declares the compliance of the end product.

The manufacturer of the end product must create a manual for the users of that product. The safety notices in the end-product manual must be written based on the end product's risk assessment.

2.3 Selection and qualification of personnel

This drive should only be installed into the end product by someone who has completed training in electronic motor assembly or has equivalent qualifications.

You should only install this drive when you are qualified to do so. Otherwise, a properly qualified person should be found for this task.

2.4 Notice on safety during operations

Basic safety rules must be followed in order to ensure that the end product can be continually operated in a safe manner. These rules must be observed while using the end product and while installing the drive.

These rules and safety measures can be categorized as follows:

- Construction measures before the installation (refer to the "Ensuring operational reliability during installation" section in Chapter "Installation").
- Safety fundamentals during the drive installation and during cable and wire routing (refer to the "Safety notices to observe during installation" section in the "Installation" Chapter).
- Using the drive in intermittent duty (refer to the "General information" section in the "Operating notes" chapter).
- Basic safety rules during operation (refer to the "Operating notes" Chapter).
- The creation of a manual for the end product which contains these and other safety rules.

Creating a user's manual

The manufacturer of the end product must create a manual for the users of that product. The safety notices in the end-product manual must be written based on the end product's risk assessment.

2.5 Product identification

2.5.1 Ratings plate

A ratings plate on each drive specifies the exact name and serial number of the drive. It also states the technical specifications valid for that particular drive. The following illustration shows where the specifications are located on the drive's ratings plate.

- ▶ The ratings plate shown is an example; the specifications for your drive may differ from this illustration.

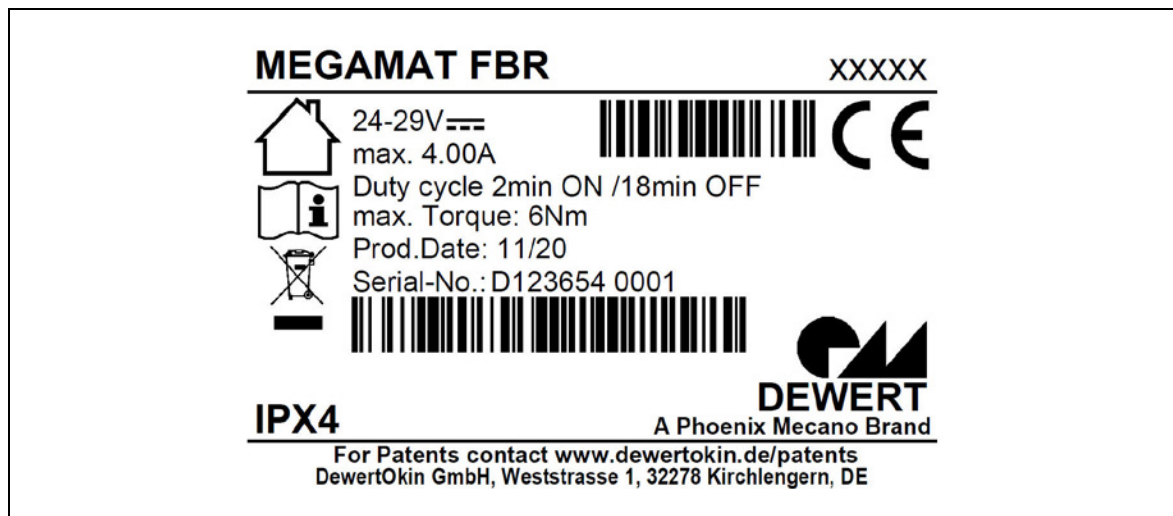





Figure 2 Ratings plate example

MEGAMAT FBR	Model name
xxxxx	Article number
24 – 29V ~	Input voltage
Max. 4.00A	Current consumption
Duty cycle: 2 min ON / 18 min OFF	Intermittent operations: 2 minutes / 18 minutes
Max. torque	Torque
Prod.date	Calendar week / year
Serial No.	Serial number
IPX4	Protection degree
	Use in dry rooms only!
	Always follow the instructions in the manual!
	Follow all special disposal instructions!
	Mark of CE conformity

3. Possible combinations

The MEGAMAT FBR single drive can be combined for use with other single drives, double drives or control units. The following basic combinations are possible:

- a MEGAMAT FBR with handset and control unit,
- a MEGAMAT FBR in combination with other drives with an additional control unit or double drive.

Systems can be customized by combining drives with the handset and control units as needed. Make sure that you switch off the electricity before connecting any components (connect while in a voltage-free state).

DewertOkin has separate system instruction manuals containing all information and instructions needed for these systems.

- ▶ Only a DewertOkin device should be used to control the drive since they have already been verified to work together.
- ▶ A control unit or a double drive is needed to operate the MEGAMAT FBR single drive. A handset is also required.

**NOTICE**

Check with DewertOkin for approval concerning any special device configurations that are customized for your requirements.

4. Description

The MEGAMAT FBR drive is an electrically driven motor that is responsible for moving the end product in a linear direction. This adjustment is carried out by a rotating shaft (e.g. a hex shaft). The movements of the MEGAMAT FBR drive are controlled using a control unit or a double drive which is connected to a DewertOkin handset.

The different drive models vary according to their:

- power of the drive,
 - torque transmission.
- We reserve the right to make unannounced technical changes in the course of our continual product improvement process!

4.1 Components



Figure 3 Main components of the MEGAMAT FBR drive

- | | |
|--|-------------------------|
| A Electrical connection | B Housing (rear) |
| C Opening for the rotating shaft (e.g. hex shaft) | D Housing |

5. Technical specifications

Rated voltage	24 V DC – 29 V DC
Current consumption at rated load	Max. 4.0 A (refer to the ratings plate)
Torque	max. 6 Nm
Mode of operation ¹ at max. rated load	Intermittent duty 2 min./18 min.
Protection class ²⁾	III
Noise level	≤ 65 dB(A)
Drive type	Single drive
Adjustment speed ³	Approx. 70 ¹ /min
Protection degree	IPX4
Dimensions and weight	
Length x width x height	Min. 208 mm x 90 mm x 82 mm
Weight	Approx. 1.5 kg
Ambient conditions for operation, storage and transport	
Transport / storage temperature	From -20 °C to +50 °C From -4 °F to +122 °F
Operating temperature	From +10 °C to +40 °C From +50 °F to +104 °F
Relative humidity	From 30% to 75%
Air pressure	From 800 hPa to 1060 hPa
Height	< 2000 m

- 1) Mode of operation: intermittent duty = 2 min./18 min. This means that after the unit is operated with its rated load for up to two minutes it must then be paused for 18 minutes. The system can malfunction if this pause is not observed!
- 2) Safety extra-low voltage
- 3) Adjustment speed: the speed at which the shaft can rotate under no load (the adjustment speed varies depending on the load).

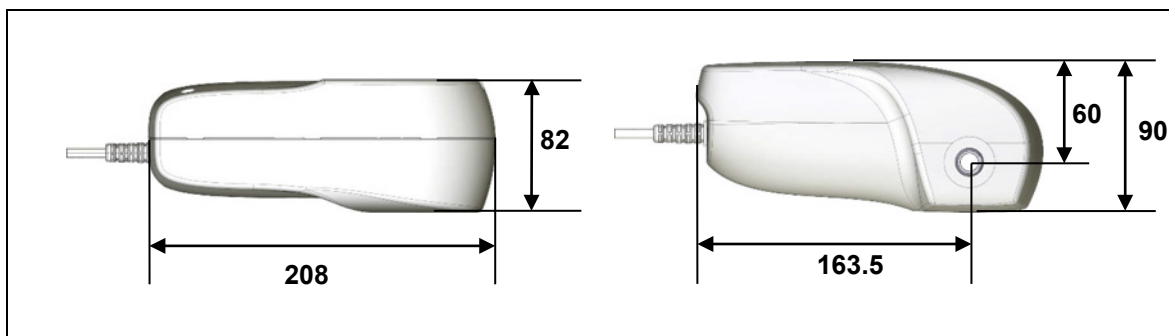

Figure 4 Dimensions of MEGAMAT FBR drive (in mm)

6. Installation



6.1 Safety notices to observe during installation

Basic safety rules must be followed in order to ensure that the end product can be continually operated in a safe manner. These rules must be observed while using the end product and while installing the drive.



6.1.1 Ensuring operational reliability during installation

The safety and reliability of the end product containing the DewertOkin drive can be ensured by using the proper construction methods described below.

Avoiding fatigue fractures

 CAUTION
<div style="display: flex; align-items: center;">  <div> <p>Drives that are incorrectly installed can undergo fatigue fractures which then create a risk of injury.</p> <ul style="list-style-type: none"> Do not position the drive at a slanted angle when installing it in the end product. A slanted angle between the intended direction of movement of the end product and the drive's direction will create shear stress and could lead to a fatigue fracture. </div> </div>

Avoiding a pinching hazard

 CAUTION
<div style="display: flex; align-items: center;">  <div> <p>The drive movement is carried out by a rotating shaft. When designing your product, you should take this into account with passive safety mechanisms and with the appropriate safety notices in your operating instructions:</p> <ul style="list-style-type: none"> Installation methods for ensuring passive safety: Install the MEGAMAT FBR drive so that none of the positions where shear and pinch hazards exist are accessible externally. </div> </div>

When preparing safety notices for the operator, Make sure that your operating instructions inform the user of these safety points.

Avoiding an overrun of the stop point with the end product

Your end product should contain mechanical end stops. These will limit the drive movement and significantly increase operational safety. DewertOkin recommends that you build such mechanical end stops into your end product.

6.2 Installation procedure

6.2.1 An installation example

Before installing the drive, make sure that you are observing all of the safety notices found in the "Safety notices to observe during installation" section.

 CAUTION	The plug for the connecting cable should be unplugged during the installation.
--	--

 NOTICE	Install the MEGAMAT FBR in its specified, horizontal mounting position (refer to Figure 5). IPX4 protection is only ensured when it is installed in a horizontal position!
---	--

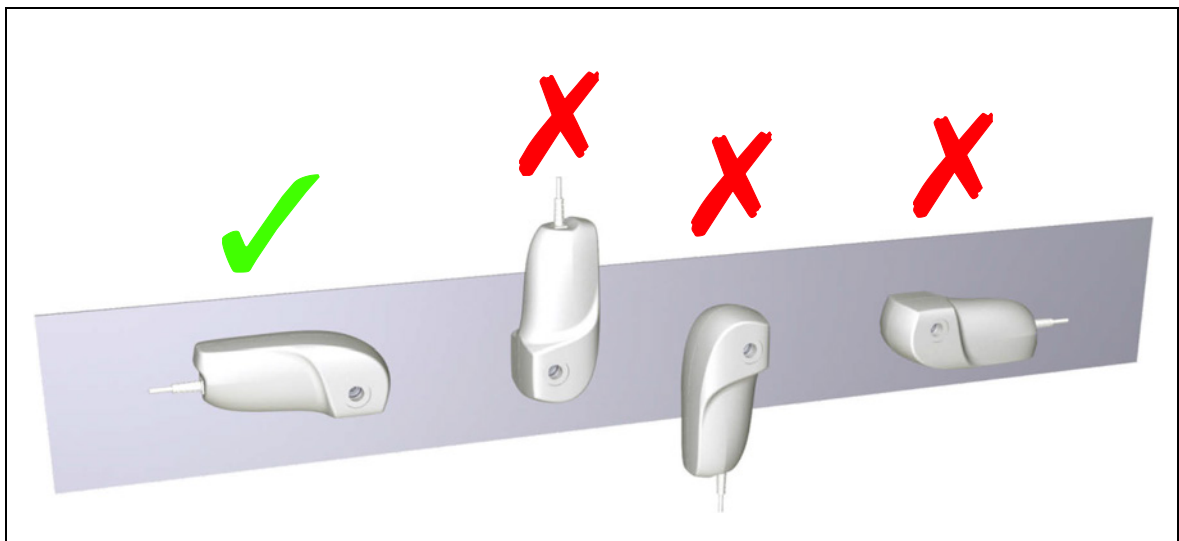

Figure 5 Permitted and prohibited mounting positions for the drive

In the following example, installation of the MEGAMAT FBR drive into the end product is shown.

- ▶ Use M5 screws (with strength grade 8.8) of an appropriate length so that the screw-in depth is no more than 10 mm. The tightening torque must not exceed 0.6 Nm.
 - ▶ Certain details may change based on the variation in use and technical modifications.
- 1 The end product should be prepared for the drive installation as follows: Drill four holes for the fastening screws and one hole for the shaft to go through.
 - 2 Use the four screws (M5, in proper length as described above) to attach the drive securely to the end product.
 - 3 Put a shaft (e.g. hex shaft: refer to Figure 7) through the corresponding hole in the end product and into the drive.

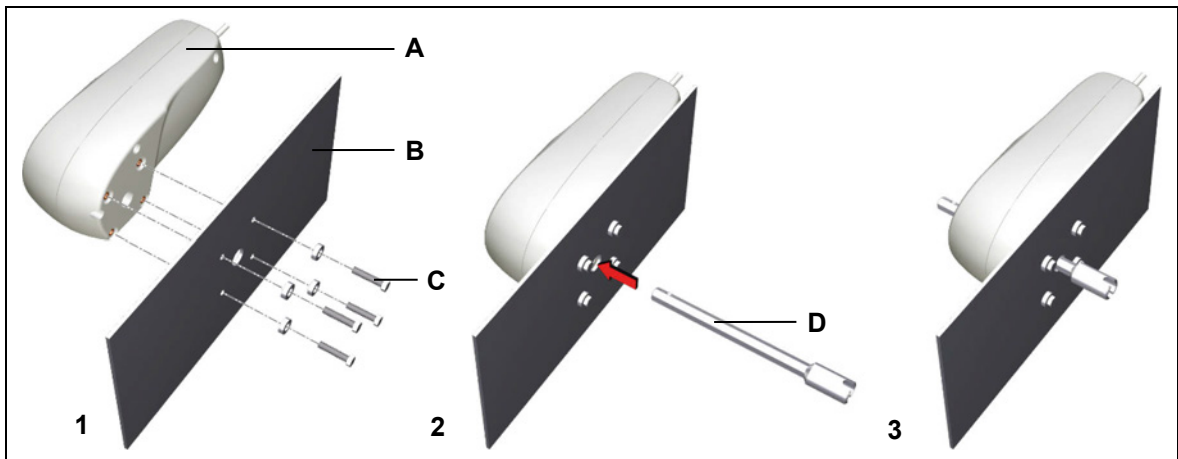

Figure 6 Installing the drive to the end product (example)

- | | |
|-------------------------------|----------------------------------|
| A MEGAMAT FBR drive | B End product (bed) |
| C Mounting screws (M5) | D Hexagonal shaft (10 mm) |

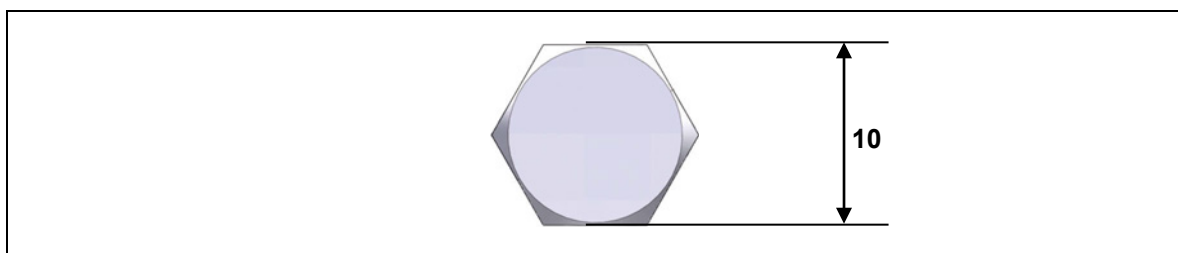





Figure 7 Diagram of the hexagonal shaft (dimensions in mm)

6.2.2 Removing the drive

	 CAUTION
	Electrical components should be connected or disconnected only when the mains power plug and the battery plug (when present) are both unplugged.

	 CAUTION
	Be sure to carry out work on the drive in a position so that no loads are bearing on it. Only in this way can you be sure to avoid any risks of crushing or injury.

► Certain details may change because of technical changes.



- 1 Move your product into a position where it is supporting no load.
- 2 Disconnect the connecting cable from the wall socket.

	NOTICE
	Be sure to support the drive's weight while you are loosening the screws.

- 3 If necessary, remove the hexagonal shaft (depending on the design of the end product).
- 4 Unscrew the screws.
- 5 Remove the drive from the end product.

7. Operating notes

The factual information contained within may be used when you are creating the end-product manual. The installation instructions do not contain all information required for the safe operation of the end product. They only describe the installation and operation of the drive as a partially assembled piece of machinery.

	 CAUTION
	<p>When creating the operating instructions, remember that the installation instructions are intended for qualified specialists and are not for typical users of the end product.</p>

7.1 General information



- ▶ Only a DewertOkin device should be used to control the drive since they have already been verified to work together.

Power-on time / intermittent operations

The MEGAMAT FBR drive has been designed for intermittent operations. Intermittent operation is an operational mode where the drive must pause after a specified maximum period of operation (power-on time). This protects the drive from overheating. Extreme overheating can cause a malfunction.



- ▶ The ratings plate specifies the maximum power-on time and the required pause intervals.

Avoiding electrical risks



	 WARNING
	<p>Make sure that all live (current-carrying) parts of the drive system and power supply cannot be touched. In particular, be sure that unused power and control unit connections are covered adequately.</p>

Avoiding cable damage

Be sure that your operating instructions inform the user about the possible cable risks.



	 CAUTION
	<p>The cables (particularly the connecting cable) should not be run over. In order to prevent injuries or drive damage, no mechanical strain should be placed on the cables.</p>

Shutting off the drive

	 CAUTION In order to shut off the drive, unplug the mains power plug and the battery plug (when present). The power plug (of the control unit or double drive) must always be accessible during operations so that emergency shut-off is possible.
---	---

8. Troubleshooting

This chapter describes troubleshooting methods for fixing problems. If you experience an error that is not listed in this table, please contact your supplier.

	 CAUTION
	<p>Only qualified specialists who have received electrician training should carry out troubleshooting and repairs.</p>

Problem	Possible cause	Solution
The handset or drive system is not functioning.	There is no mains supply voltage.	Connect the mains power.
	The hand switch or drive system is defective.	Please contact your supplier or sales agent.
The drive is suddenly not capable of movement.	Possibly the thermal circuit breaker on the transformer has been triggered.	The drive system should be allowed to pause for 20 to 30 minutes with the power cord disconnected.
	The thermal fuse on the transformer may have been triggered.	Please contact your supplier or sales agent.
	The unit's fuse may have been triggered.	Please contact your supplier or sales agent.
	There is no mains supply voltage.	Connect the mains power.
	A lead-in connection has been interrupted (mains power, hand switch or auxiliary drive).	Check the cables and reinsert them, if required.

9. Maintenance

- ▶ You should only use spare parts which have been manufactured or approved by DewertOkin. Only these parts will guarantee a sufficient level of safety.

9.1 Maintenance

Type of check	Explanation	Time interval
Check the function and safety of the electrical system.	A qualified electrician should carry out this inspection. (Refer to the "Electrical connection" section in the "Installation" Chapter.)	Periodic inspections can be carried out at intervals based on the risk assessment which you conduct for your end product.
Look over the housing periodically for any signs of damage.	Check the housing for breaks or cracks. The IP-class protection will be impaired by any breakage or cracks.	At least every six months.
Look over the plug-in connections and electrical access points for signs of damage.	Check that all electrical cables and connections are firmly seated and correctly positioned.	At least every six months.
Look over the cables for any signs of damage.	Check the connecting cables for pinching or shearing. Also check the strain relief and kink protections mechanisms, in particular after any mechanical load.	At least every six months.

9.2 Cleaning and care

The MEGAMAT FBR drive was designed so that it would be easy to clean. Its smooth surfaces simplify the cleaning process.

	NOTICE
	Never clean the drive in an automated washing system or with a high-pressure cleaner. Do not allow fluids to penetrate the drive. Damage to the system could result.

- 1 Always disconnect the mains power plug before you start to clean the drive!
- 2 Clean the MEGAMAT FBR drive using a moist cloth while it is in its retracted position.
- 3 Make sure that you do not damage the drive's connecting cable.

	NOTICE
	Do not use a cleanser that contains benzene, alcohol or similar solvents.

10. Disposal

10.1 Packaging material

The packaging material should be sorted into recyclable components and then disposed of in accordance with the appropriate national environmental regulations (in Germany according to the recycling law KrWG from 01.06.2012; internationally according to the EU Directive 2008/98/EC (Waste Framework Directive WFD as of 12.12.2008)).

10.2 Drive components

The MEGAMAT FBR drive consists of electronic components, cables and metal and plastic parts. You should observe all corresponding national and regional environmental regulations when disposing of the MEGAMAT FBR drive.

The disposal of the product is regulated in Germany by Elektro-G, internationally by the EU Directive 2012/19/EC (WEEE), or by any applicable national laws and regulations.



The MEGAMAT FBR drive should not be disposed of with normal household waste!

Einbauerklärung

nach Anhang II der EU-Maschinenrichtlinie
2006/42/EG

Der Hersteller

Declaration of Incorporation

*According to Appendix II of the EU Machinery
Directive 2006/42/EC*

The manufacturer:

DewertOkin GmbH
Weststraße 1
32278 Kirchlengern
Deutschland - Germany

erklärt hiermit, dass nachstehend beschriebene
unvollständigen Maschinen

*declares that the incomplete machines described
below*

MEGAMAT FBR

die folgenden grundlegenden Anforderungen der
Richtlinie Maschinen (2006/42/EG) erfüllt:

*complies with the following basic requirements of the
Machinery Directive (2006/42/EC):*

Abschnitt:

Sections:

1.1.3; 1.3.3; 1.3.4; 1.3.7; 1.5.1; 1.5.2; 1.5.5; 1.5.6; 1.5.7; 1.5.8; 1.5.9; 1.5.10; 1.5.13

Die unvollständige Maschine darf erst dann in Be-
trieb genommen werden, wenn festgestellt wurde,
dass die Maschine, in die die unvollständige Ma-
schine eingebaut werden soll, den Bestimmungen
der Richtlinie Maschinen (2006/42/EG) entspricht.

*You may only operate this incomplete machine after
you have confirmed that the end product (into which
this machine will be installed) complies with the
Machinery Directive 2006/42/EC.*

Der Hersteller verpflichtet sich, die speziellen Unter-
lagen zur unvollständigen Maschine einzelstaatli-
chen Stellen auf begründetes Verlangen elektronisch
zu übermitteln. Die zur Maschine gehörenden
speziellen technischen Unterlagen nach Anhang VII
Teil B wurden erstellt.

*On reasonable request, the manufacturer is obliged
to send the special documentation accompanying the
partially completed machinery in electronic form to
the appropriate national institution. The special
technical documents corresponding to the machine
have been created according to Appendix VII, part B.*

Für die Zusammenstellung der technischen Unter-
lagen ist bevollmächtigt: DewertOkin GmbH
Weststraße 1
32278 Kirchlengern
Tel.: 05223 979-0
Deutschland - Germany

*For preparation of the technical documentation is
authorized: DewertOkin GmbH
Weststraße 1
32278 Kirchlengern
Tel.: 05223 979-0
Deutschland - Germany*

Kirchlengern, Germany 16 March 2020



Dr.-Ing. Josef G. Groß
Geschäftsführer / Managing Director

EG-Konformitätserklärung

Nach Anhang IV der EMV-Richtlinie 2014/30/EU

Nach Anhang IV der EU-Niederspannungsrichtlinie 2014/35/EU

Nach Anhang VI der RoHS-Richtlinie 2011/65/EU (inkl. Delegierte Richtlinie (EU) 2015/863)

Der Hersteller

DewertOkin GmbH
Weststraße 1
32278 Kirchlegern
Deutschland - Germany

erklärt hiermit, dass das Produkt

EU Declaration of Conformity

In compliance with Appendix IV of the EMC-Directive 2014/30/EU

In compliance with Appendix IV of the LVD-Directive 2014/35/EU

In compliance with Appendix VI of the EU RoHS Directive 2011/65/EU (incl. Commission delegated Directive (EU) 2015/863)

The manufacturer:

declares that the following product

MEGAMAT FBR¹⁾

die Anforderungen folgender EG-Richtlinien erfüllt:

Richtlinie über elektromagnetische Verträglichkeit 2014/30/EU

Niederspannungsrichtlinie 2014/35/EU

DELEGIERTE RICHTLINIE (EU) 2015/863 DER KOMMISSION vom 31. März 2015 zur Änderung von Anhang II der Richtlinie 2011/65/EU des Europäischen Parlaments und des Rates hinsichtlich der Liste der Stoffe, die Beschränkungen unterliegen.

Angewendete Normen

meets the requirements of the following EU directives:

Electromagnetic Compatibility Directive 2014/30/EU

Low Voltage Directive 2014/35/EU

COMMISSION DELEGATED DIRECTIVE (EU) 2015/863 of 31 March 2015 amending Annex II to Directive 2011/65/EU of the European Parliament and of the Council as regards the list of restricted substances.

Applied standards:

- EN 60335-1:2012/A11:2014
- EN 55014-1:2006/A1:2009/A2:2011
- EN 55014-2:1997/A1:2001/A2:2008
- EN 61000-3-2:2014
- EN 61000-3-3:2013
- EN 62233:2008

Konstruktive Änderungen, die Auswirkungen auf die in der Montageanleitung angegebenen technischen Daten und den bestimmungsgemäßen Gebrauch haben, das Produkt also wesentlich verändern, machen diese Konformitätserklärung ungültig!

This declaration of conformity is no longer valid if constructional changes are made which significantly change the drive system (i.e., which influence the technical specifications found in the instructions or the intended use)!



Kirchlegern, Germany 16 March 2020

Dr.-Ing. Josef G. Groß
Geschäftsführer / Managing Director

¹⁾ mit DewertOkin Steuerung / with DewertOkin Control Unit

Additional information

MEGAMAT FBR drive system

The following standards and norms were used in the versions with at least IPX4 and higher in according to

- EN 60601-1:2006 + A1:2013, IEC 60601-1:2005 + A1:2012 (short description: Edition 3.1), Medical electrical equipment.
- EN 60601-1-2:2015, IEC 60601-2-2:2014 (short description: Edition 4.0), EMC

IEC/EN60601-1, Section 4	General requirements
IEC/EN60601-1, Section 6	Classification
IEC/EN60601-1, Section 7.1	Labelling – general
IEC/EN60601-1, Section 7.2	Labelling – inscriptions
IEC/EN60601-1, Abschnitt 8	Protection against electrical danger
IEC/EN60601-1, Section 11.1	Overheating protection
IEC/EN60601-1, Section 11.2	Fire prevention
IEC/EN60601-1, Section 11.3	Design requirements for fire-resistant housing
IEC/EN60601-1, Section 13	Dangerous situations and error conditions
IEC/EN60601-1, Section 16.6	Leakage current
IEC/EN60601-1, Section 17	Electromagnetic compatibility
IEC/EN60601-2-52, Section 201.11.6.5.101	Protection against water ingress: only applied for at least IPX4
IEC/EN60601-2-52, Section 201.9.8.3.2	Static load



DEWERT OKIN

A DewertOkin Technology Group Company

DewertOkin GmbH
Weststrasse 1
Kirchlengern 32278, Germany
Tel: +49 (0)5223/979-0
Fax.: +49 (0)5223/75182
<http://www.dewertokin.de>
Info@dewertokin.de

ID No.: 82715