



MC11 Control Unit

Installation Instructions

(Translation of the original installation instructions)

Foreword

Document revision history

Version	Date	Modification, change
(-)	09/10	First release
(a)	02/11	Temperature monitoring
(b)	09/11	Mounting to the end product
(c)	07/12	Edition II
(d)	12/13	Second ratings plate
6.0	04/20	Edition III

Disclaimer and exclusion of liability

DewertOkin is not responsible for damage resulting from:

- failure to observe these instructions,
- changes made to this product which have not been approved by DewertOkin, or
- the use of replacement parts which have not been approved or manufactured by DewertOkin.

Manufacturer's address

DewertOkin GmbH
 Weststrasse 1
 32278 Kirchlengern,
 Germany
 Tel: +49 (0)5223/979-0
 Fax.: +49 (0)5223/75182
<http://www.dewertokin.de>
Info@dewertokin.de

Creation of a complete operating instruction manual for the entire end product

These instructions are only intended to be used by the end-product manufacturer. They should not be given to the operator of the end product. The factual information contained within may be used as a basis when creating the end-product manual.

The warning and danger notices are best suited for use in the end product's manual. However, it is not sufficient to simply follow these notices. You should also carry out an internal risk assessment for your end product. This can then be used as the basis for the safety notices in your manual.

Usage in medical products

The MC11 control unit is not a medical product. If used in a medical end product, you (the end manufacturer) are obliged to ensure compliance with EC directives and to ensure that other pertinent medical product regulations are maintained.

Table of Contents

Foreword	3
Document revision history	3
Disclaimer and exclusion of liability	3
Manufacturer's address	3
Creation of a complete operating instruction manual for the entire end product	3
Usage in medical products	3
Table of Contents	4
1. General Information	6
1.1 Configurations	6
1.2 About these installation instructions	6
1.3 Conventions used	6
2. Safety notices	7
2.1 Proper and intended usage	7
2.2 Selection and qualification of personnel	8
2.3 Notice on safety during operations	8
2.4 Product labelling	9
3. Possible combinations	10
3.1 Layout of system connections	10
4. Description	11
4.1 Components	11
5. Technical specifications	14
6. Installation	16
6.1 Safety notices to observe during installation	16
6.2 Installation procedure	17
7. Operating notes	25
7.1 General information	25
7.2 Notice for operating with optional configuration	28
8. Troubleshooting	29
9. Maintenance	30
9.1 Maintenance	30

9.2	Cleaning and care	31
10.	Disposal	32
10.1	Packaging material	32
10.2	Components in the control unit	32
	EU Declaration of Conformity	33
	Additional information	34

1. General Information



1.1 Configurations

The MC11 control unit is available in different versions: with and without the designation CARE or HOSP. The "Possible Combinations" Chapter describes the different device combinations that are available.

1.2 About these installation instructions

In order to install the MC11 control unit successfully and safely in the end product, these installation instructions must be observed. These instructions are not an operating manual for the end product.

These instructions will help you to minimize danger, repair costs and down times. They will also help you to maximize the reliability and lifespan of the end product.

	 CAUTION
	<p>The notices in these instructions must be followed! Following the guidelines during installation and connection procedures will help to minimize:</p> <ul style="list-style-type: none"> • the risk of accident and injury, and • damage to the MC11 control unit or the end product.

These installation instructions have been written with due care and attention. However, we cannot guarantee that the data, images and drawings are complete and correct nor do we accept any liability for the information contained therein, unless required by law.



- ▶ We reserve the right to make unannounced technical changes in the course of our continual product improvement process!



1.3 Conventions used

Notices which do not relate to safety are indicated in these instructions with a symbol:

- ▶ Triangular notice symbol

Explanations of warning notices

	 WARNING
	<p>WARNING indicates a hazardous situation which, if not avoided, could result in death or serious injury.</p>

	 CAUTION
	<p>CAUTION indicates a hazardous situation which, if not avoided, could result in minor or moderate injury.</p>



	NOTICE
	<p>NOTICE is used to address practices which are not related to personal injury but may result in damage to the product or surroundings.</p>

2. Safety notices

2.1 Proper and intended usage



The MC11 control unit is intended for use



- as a control unit and power supply for the appropriate DewertOkin drive systems.
- for care purposes,
- or in hospitals.

 CAUTION
 <p>The MC11 control unit should only be used for the applications described above. Any other use is forbidden. Improper usage can lead to accidents or destruction of the unit. Such non-approved applications will lead immediately to the expiration of all guarantee and warranty claims on the part of the end-product manufacturer against the manufacturer.</p>

2.1.1 Improper usage

Be sure to follow the notices below concerning improper usage. You should include them in your product manual in order to inform the users of your end product.

 WARNING
 <p>The MC11 control unit should not be used:</p> <ul style="list-style-type: none"> • in any environment where combustible or explosive gases or vapours (e.g., anaesthesiology) may be present, • in the proximity of open fires or other heat sources (such as furnaces, ovens or direct sunlight), • as a power source for toys or games, • in any application that will be cleaned with an automated washing system, • in a moist environment, or • outdoors.

 CAUTION
 <p>The MC11 control unit may not be operated by:</p> <ul style="list-style-type: none"> • by small children, • by frail or infirm persons without supervision, or • in the proximity of small children.

The MC11 control unit can be used by children of 8 years and older, persons with reduced physical, sensory or mental capabilities, or persons with lack of experience or knowledge when they are supervised or instructed concerning the safe use of the device and when they understand the resulting risks. Do not allow children to play with this device. The cleaning and user maintenance must not be carried out by children without supervision.

- ▶ You should only use spare parts which have been manufactured or approved by DewertOkin. Only these parts will guarantee a sufficient level of safety.

Using the drive systems in medical applications

This DewertOkin product meets the safety requirements described in IEC 60601-1.

We strongly recommend that the end product (including all its components) which you are manufacturing for a medical application should also comply with the safety requirements found in IEC 60601-1.

You should make sure that the mechanical movement of the motor in your end product poses no risk of injury. Conduct a risk analysis for the end product for this purpose. You should also include safety notices in the instructions for the end product and technical safeguards in your product to eliminate any risk.

2.2 Selection and qualification of personnel

This MC11 control unit should only be installed into the end product by someone who has completed training in electronic motor assembly or has equivalent qualifications.

You should only install the MC11 control unit when you are qualified to do so. Otherwise, a properly qualified person should be found for this task.

2.3 Notice on safety during operations

Basic safety rules must be followed in order to ensure that the end product can be continually operated in a safe manner. These rules must be observed while using the end product and while installing the MC11 control unit.



These rules and safety measures can be categorized as follows:

- Construction measures before the installation (refer to the "Ensuring operational reliability during installation" section in the "Installation" Chapter)
- Safety fundamentals during the installation of the MC11 control unit and during cable and wire routing (refer to the "Electrical connection" section in the "Installation" Chapter)
- Basic safety rules during operation (refer to the "Operating notes" Chapter).
- The creation of a manual for the end product which contains these and other safety rules.

2.3.1 Creating a user's manual

The manufacturer of the end product must create a manual for the users of that product. The safety notices in the end-product manual must be written based on the end product's risk assessment.

2.3.2 Electrical safety

	 WARNING
	<p>Be careful; there is a risk of electrical shock! Be sure to unplug the power cord on the MC11 control unit before you begin assembly!</p>

The MC11 control unit should not be opened! You must properly dispose of malfunctioning or broken units.

2.4 Product labelling

2.4.1 Ratings plate

A ratings plate (or type label) on each MC11 control unit specifies the exact name and serial number of the drive. It also states the technical specifications valid for that particular control unit. The following illustration shows where the specifications are located on the ratings plate of the MC11 control unit.

- ▶ The ratings plates shown are examples; the specifications for MC11 control unit may differ from this illustration.

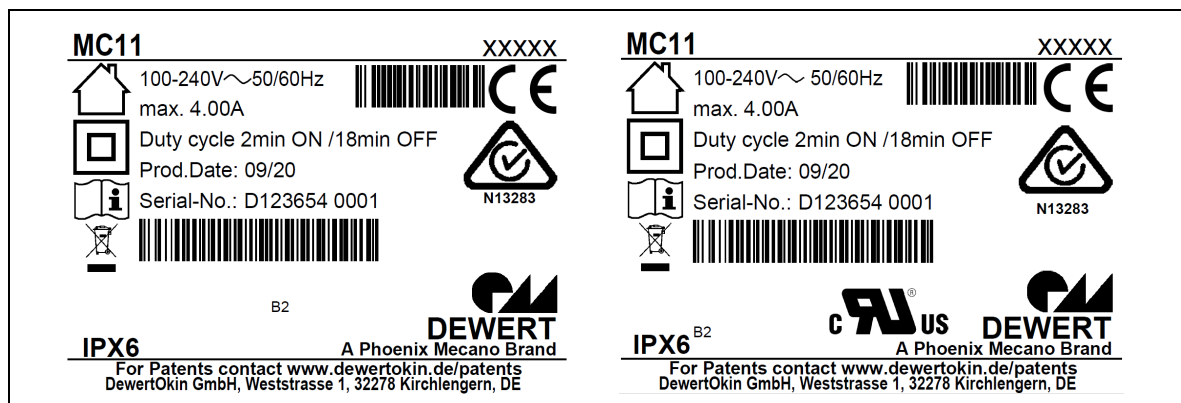







Figure 1 Ratings plate example for the MC11 control unit

MC11	Model name
xxxxxx	Article number
100V – 240V ~ 50/60Hz	Input voltage and frequency
Max. 4.00A	Rating of fuse
Duty cycle: 2 min ON / 18 min OFF	Intermittent operations: 2 minutes / 18 minutes
Prod.date	Production date: Calendar week / year
Serial No.	Serial number
IPX6	Protection degree
	Use in dry rooms only!
	Protection class: II
	Follow all special disposal instructions!
	Always follow the instructions in the manual!
	Conformity mark

3. Possible combinations

The MC11 control unit can be combined with one or more drives. The following basic combinations are possible:

- a MEGAMAT MLZ drive attached to the MC11 control unit and a handset,
- a MEGAMAT MLZ drive attached to the MC11 control unit, up to three additional single drives and a handset,
- an additional Supervisor, Control Box or short-circuit plug can optionally be connected,
- an optional connection for a rechargeable battery.

Systems can be customized by combining drives, control units, handset and batteries as needed.

DewertOkin has separate system instruction manuals containing the additional information and instructions needed for these systems.

3.1 Layout of system connections

Refer to the sticker on the control unit for details about layout and positioning of the connections. The sticker is located above the sockets. It indicates the proper type of connections. The layout of the connection scheme is individual and depends on the system specifications. Figure 2 is only an example and shows you where the label is attached.

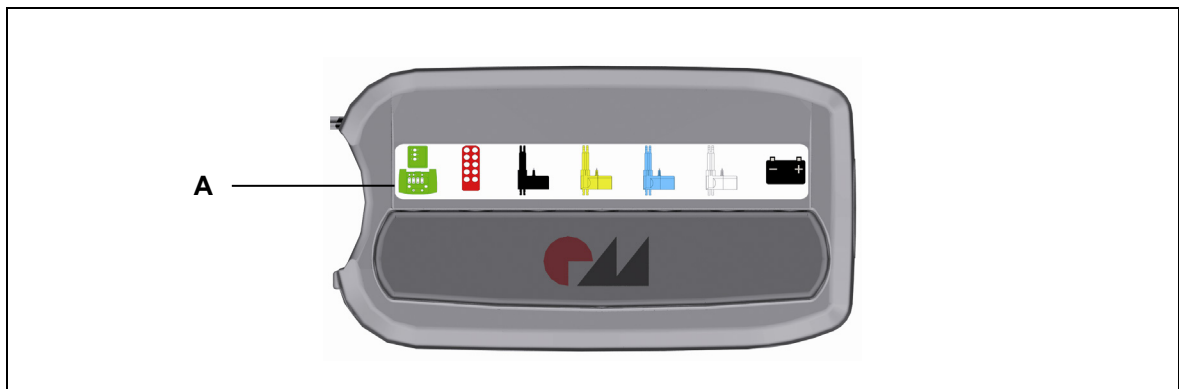

Figure 2 An illustration of where the connection layout sticker is positioned on the control unit

A Layout of connections

	NOTICE
	Only connect the components according to the specifications found on the sticker on the control unit. Any other arrangement of connections may damage the control unit.

4. Description

The MC11 control unit is a control unit and power supply for one or more DewertOkin drives. A pluggable power cord is used to connect the MC11 control unit to the mains power supply. The MC11 control unit has a non-referenced (unearthed) circuit which is separated from the supply voltage by means of doubled reinforced insulation.

- ▶ We reserve the right to make unannounced technical changes in the course of our continual product improvement process!

4.1 Components

The housing of the MC11 control unit has a connection for the power feed-in and connections for the drives and handset. The connection for the drive/handset is fitted with a mechanism to guard against accidental unplugging. The MC11 control unit can be plugged into a MEGAMAT MLZ drive.

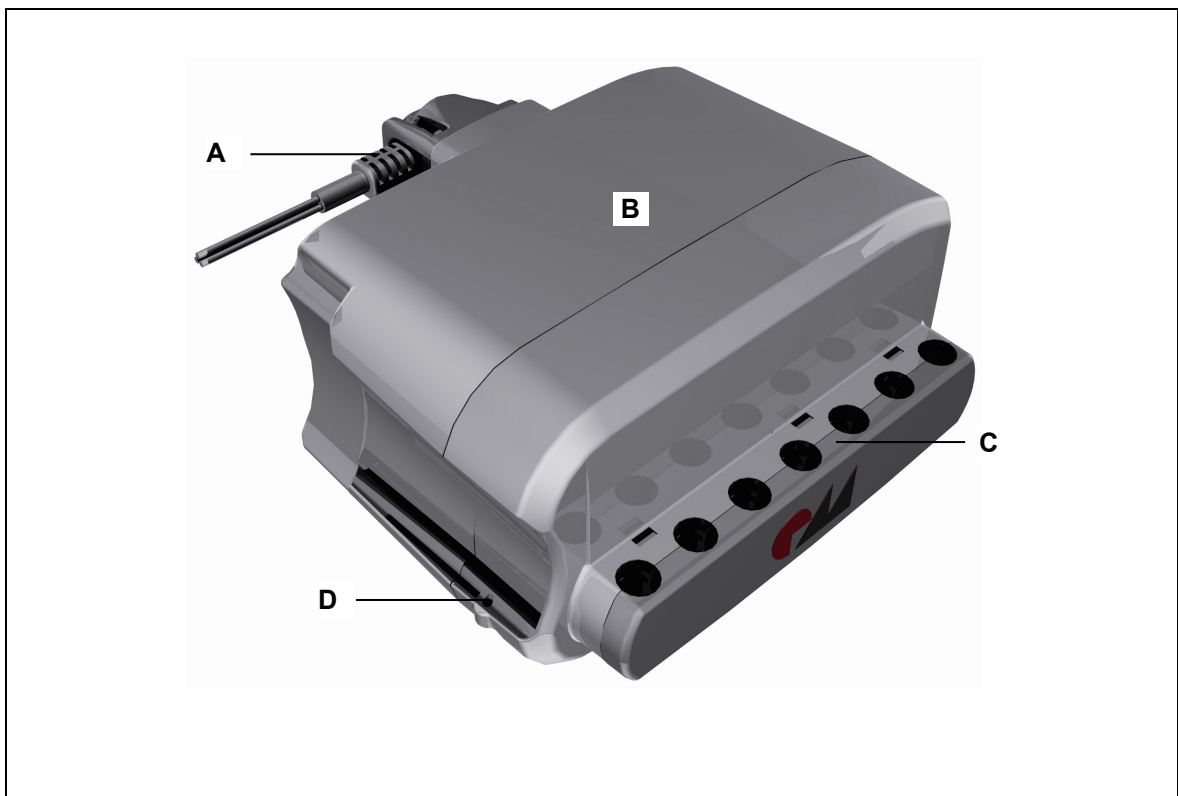





Figure 3 Components for the MC11 control unit

- | | |
|--|---|
| A Power supply via pluggable power cord | B MC11 control unit |
| C Connection sockets for drives and handset with mechanism to protect against pulling out | D Option for screwing to the drive MEGAMAT MLZ |

4.1.1 Mains power supply connection

	 WARNING
	<p>Please follow these operating instructions carefully. You could be injured by fire or electrical shock if you do not follow these assembly instructions.</p>

The appropriate power cable is included, depending on the regional version (USA, continental Europe, the UK or Australia).

	 WARNING
	<p>Only use the proper power cable that is permitted in your country. Be sure to use the correct plug shape (refer to).</p>

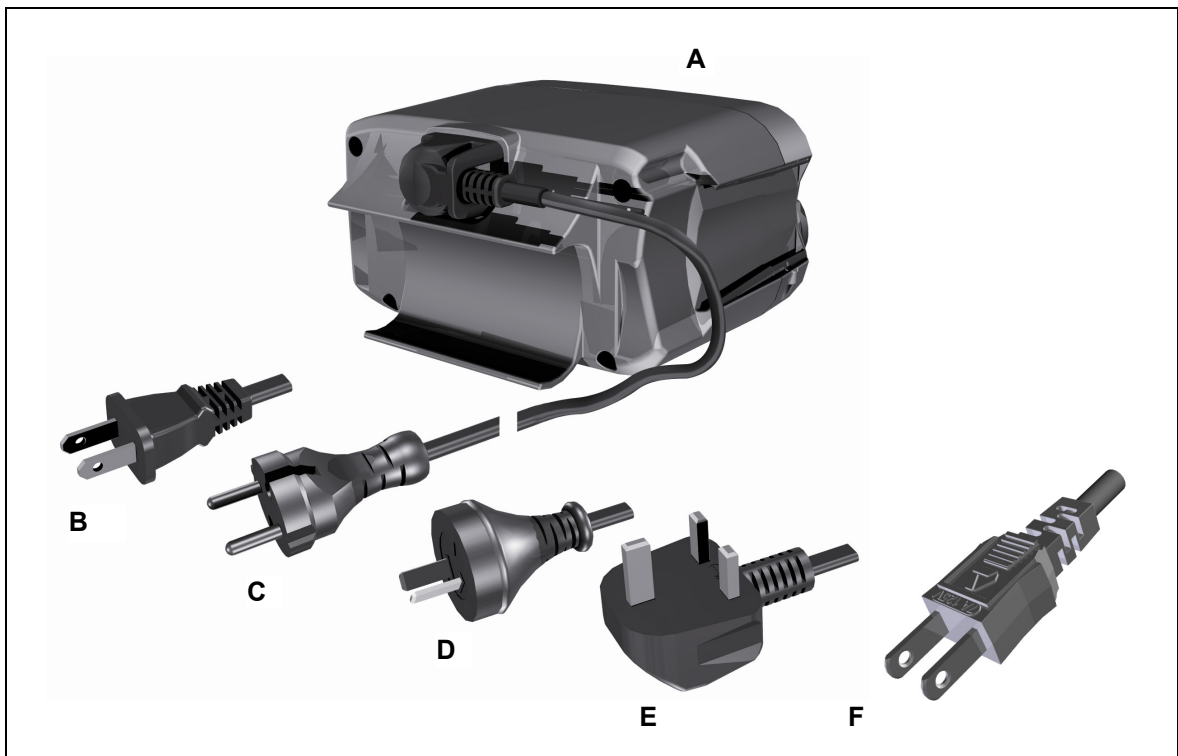

Figure 4 Power cord, regional variants

- | | |
|--|--|
| A MC11 control unit | B Power plug (USA version) |
| C Power plug (German version) | D Power plug (Australian version) |
| E Power plug (United Kingdom version) | F Power plug (Japan version) |

4.1.2 Optional grounding cable

The optional grounding cable (refer to Figure 5) can be used to connect the end product with the grounding conductor on the power supply cord. Attach the grounding cable to your application in compliance with all applicable standards and using state-of-the-art methods.

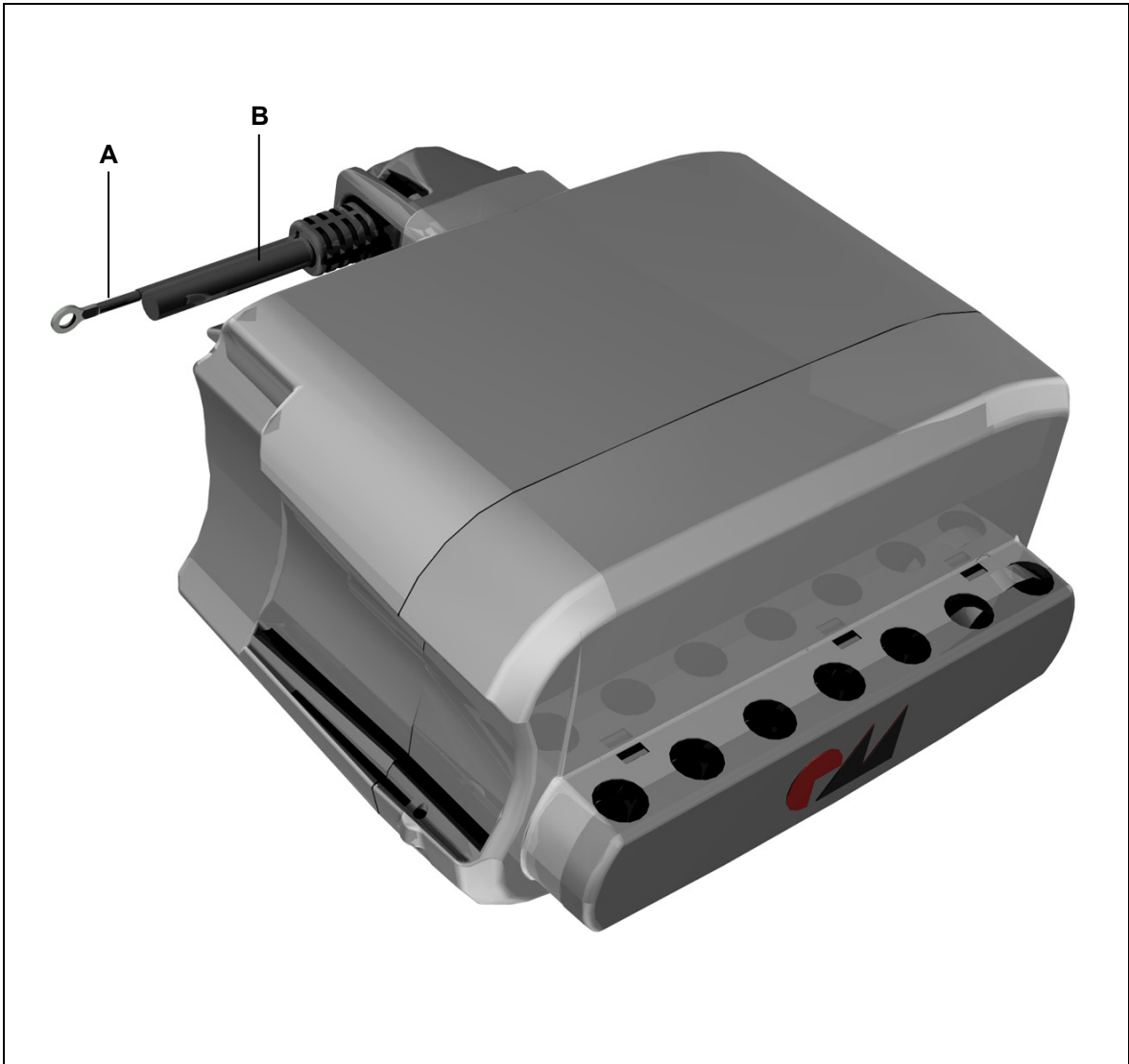

Figure 5 Grounding cable on the power supply cord of the MC11 control unit

A Optional grounding cable

B Power cable

5. Technical specifications

Mains power supply connection	100 – 240V AC, 50/60Hz
Current consumption at nominal operations	Max. 4.00 A (depending on input voltage)
Mode of operations ¹	Intermittent duty 2 minutes /18 minutes
Protection class	II
Permitted current consumption of all additional drives ²	Max. 11 A (depending on version)
Protection degree	IPX6
Colours	Refer to sales brochure
Dimensions and weight	
Length x width x height	169 mm x 166 mm x 92 mm
Weight	Approx. 770 g
Ambient conditions for operation, storage and transport	
Transport / storage temperature	From -20 °C to +50 °C From -4 °F to +122 °F
Operating temperature	From +10 °C to +40 °C From +50 °F to +104 °F
Relative humidity	From 30% to 75%
Air pressure	From 800 hPa to 1060 hPa
Height	< 2000 m

¹⁾ Mode of operation: intermittent duty 2 minutes/18 minutes. This means that after the unit is operated with its rated load for up to two minutes it must then be paused for 18 minutes. The system can malfunction if this pause is not observed!

²⁾ No more than two drives may be operated at rated load simultaneously!

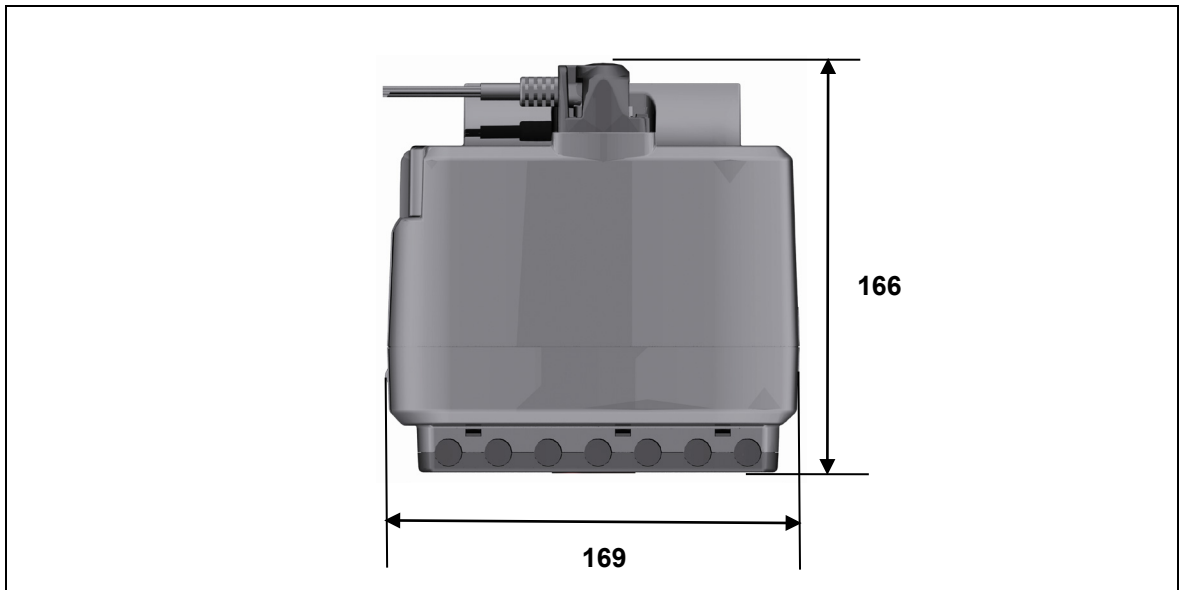

Figure 6 Dimensions of the MC11 control unit, top view (in mm)

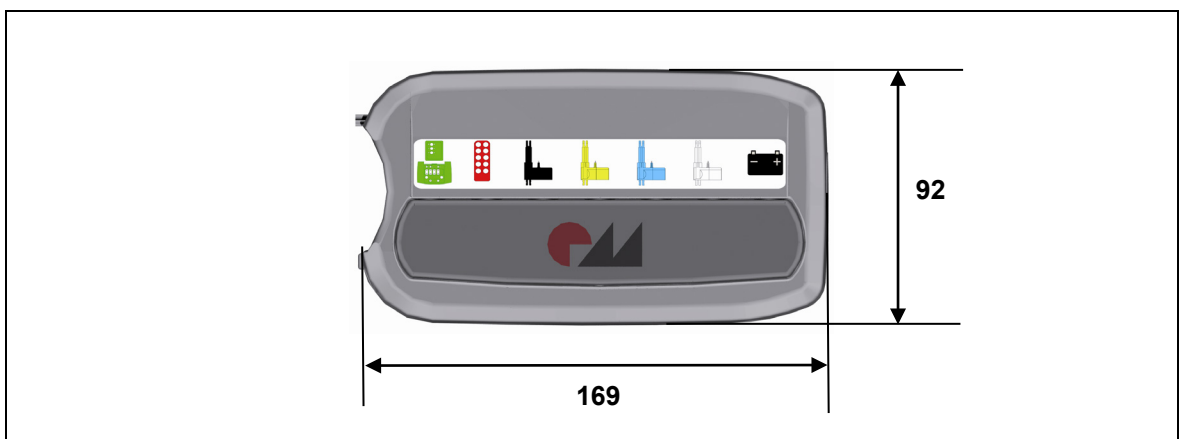

Figure 7 Dimensions of the MC11 control unit, front view (in mm)

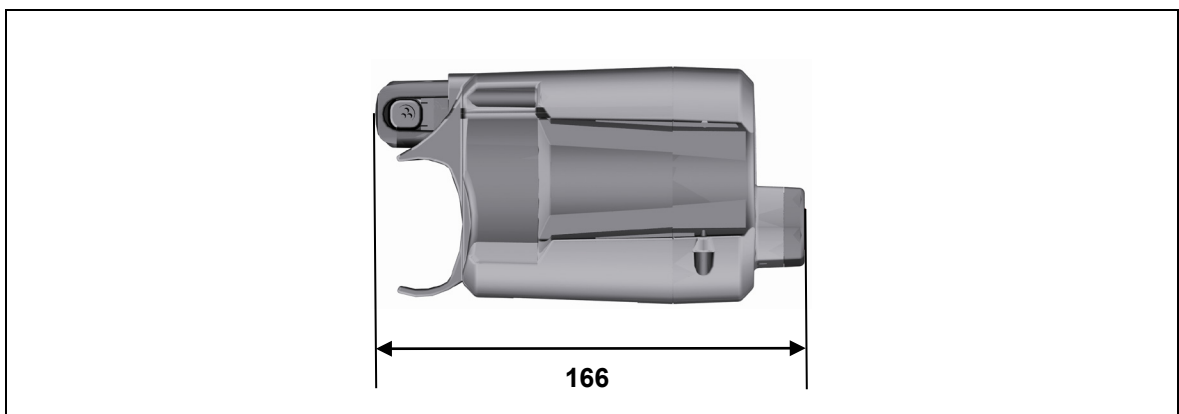

Figure 8 Dimensions of the MC11 control unit, side view (in mm)

6. Installation

6.1 Safety notices to observe during installation

Basic safety rules must be followed in order to ensure that the end product can be continually operated in a safe manner. These rules must be observed while using the end product and while installing the MC11 control unit.

6.1.1 Avoiding electrical faults



The power supply cord is designed to be connected to an outlet near the floor. Be sure to consider the length of the power cord when designing the dimensions for your application in order to minimize the associated risks.

6.1.2 Ensuring operational reliability during installation

The safety and reliability of the end product containing DewertOkin components can be ensured by using the proper construction methods as described below.

Overheating

A thermal monitoring mechanism switches the MC11 control unit off if it overheats.

 CAUTION	 <p>The MC11 control unit is equipped with a thermal monitoring mechanism that triggers when the unit overheats. If the temperature control has triggered, remove the control unit from the power supply, allow it to rest for 20 to 30 minutes and try again. If the control unit still does not function, please contact your supplier or sales agent.</p>
--	---

Installation dimensions for the MEGAMAT MLZ drive

The installation length of the MEGAMAT MLZ drive should not be less than 291 mm (installation length of MEGAMAT MLZ drive together with standard clevis). The drive or drive control unit could be mechanically damaged if the installation length is shorter than this.

Mechanical construction

A shield covering the sockets protects the connections from mechanical damage and accidental unplugging.

6.2 Installation procedure

Before installing the MC11 control unit, make sure that you are observing all of the safety notices found in the "Safety notices to observe during installation" section.

6.2.1 Mounting the MC11 control unit to the MEGAMAT MLZ drive

NOTICE	
	<p>The installation length of the MEGAMAT MLZ drive should not be less than 291 mm (installation length of MEGAMAT MLZ drive together with standard clevis). The drive or drive control unit could be mechanically damaged if the installation length is shorter than this.</p>

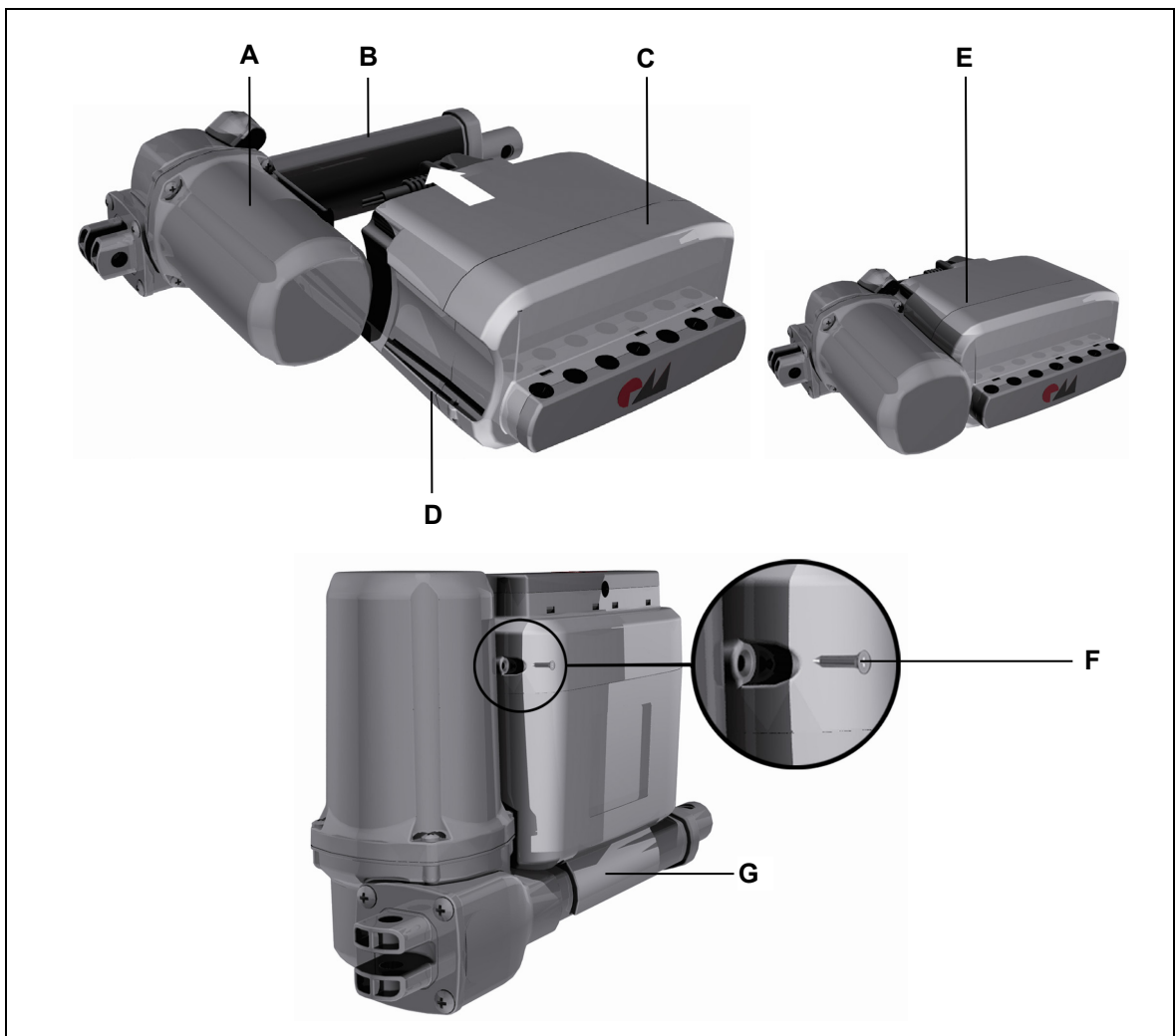



Figure 9 Mounting the MC11 control unit



- | | |
|--|--|
| A MEGAMAT MLZ drive (an example) | B Guidance profile |
| C MC11 control unit | D Guidance groove for the motor casing cover on the drive MEGAMAT MLZ |
| E MC11 control unit attached to the drive | F Fastening screw (3.5 mm x 13 mm) |
| G Support for guidance profile | |

The MC11 control unit is mounted by snapping it onto the MEGAMAT MLZ drive.

	 CAUTION
	You should only connect and disconnect the cables when they are completely disconnected from any live current!

- 1 Push the MEGAMAT MLZ drive along the guidance groove (**D**) until the guidance profile (**B**) snaps onto the support (**G**).
- 2 A screw can also be used to secure the MEGAMAT MLZ drive to the MC11 control unit. Tighten the screw (F), as shown in Figure 9. Use a fastening screw with the dimensions 3.5 mm x 13 mm (ISO 7049-ST).
- 3 The drive can then be connected to the proper socket on the MC11 control unit (refer to the "Electrical connection" section).

6.2.2 Electrical connection

	 CAUTION
	Electrical components should be connected or disconnected only when the power supply cord is unplugged.

	NOTICE
	There is a delay after the supply voltage is applied before the device actually turns on. Wait at least 2 seconds before the initial commissioning.

Routing the electrical cables

When routing the cables, be sure that:

- the cables cannot get jammed,
- no mechanical load (such as pulling, pushing or bending) will be put on the cables, and
- the cables cannot be damaged in any way.

Fasten all cables (especially the connecting cables) to the end product using sufficient kink prevention methods. Be sure that the design of the end product prevents the connecting cables from coming into contact with the floor during transport.

Connecting the MEGAMAT MLZ drive to the MC11 control unit

The electrical connection from the MEGAMAT MLZ drive to the MC11 control unit is made by plugging the drive plug into the MC11 control unit.

Take off the shield cover (refer to the "Opening the shield cover" section) and plug the drive plug into the proper socket. Make sure that you use the proper connection position as specified in the connection layout illustration (refer to the "Layout of system connections" section).

Opening the shield cover

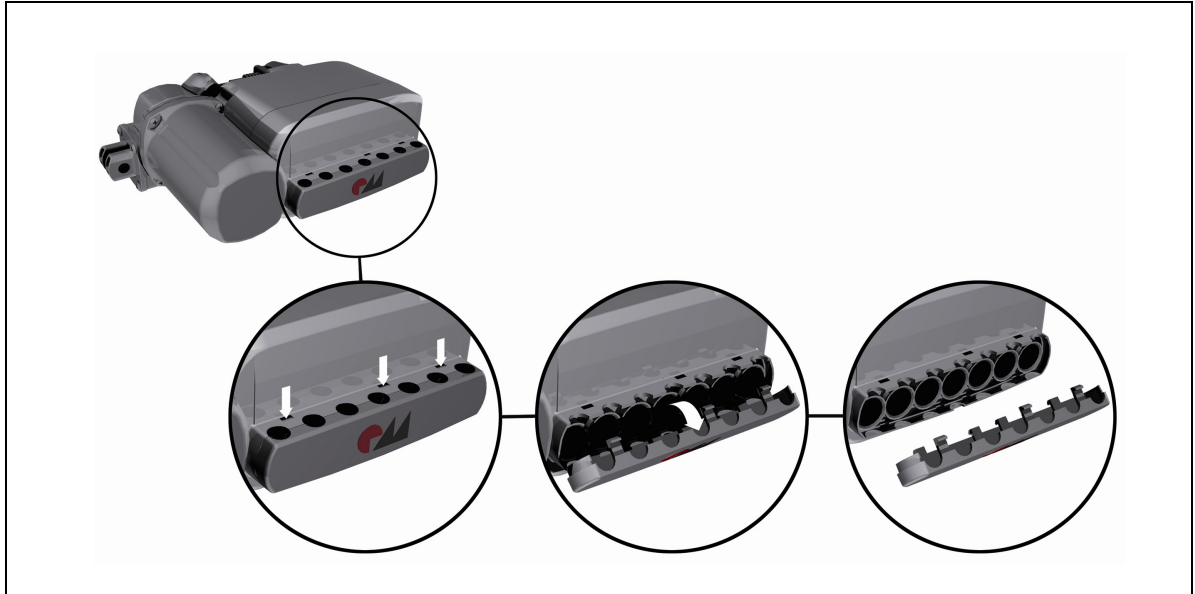





Figure 10 Opening the shield cover on the MC11 control unit

- 1 Pull out the mains plug from the outlet.



	CAUTION
	<p>You should only connect and disconnect the cables when they are completely disconnected from any live current!</p>

- 2 Use a suitable tool to press the three locking clips down in the notches as shown in Figure 10. At the same time, tilt the shield cover forward so that the clips come out of the notches.
- 3 Remove the shield cover.
- 4 You can now connect or disconnect a plug and socket. Be sure to use the proper socket (the assignments of plugs to sockets is shown in the connection layout diagram). (Figure 2 shows the connection positions.)

6.2.3 Connecting the pluggable power cord to the MC11 control unit

	 WARNING
	<p>Please follow these operating instructions carefully. You could be injured by fire or electrical shock if you do not follow these assembly instructions.</p>

The appropriate power cord is included, depending on the regional version (USA, continental Europe, the UK, Australia or Japan).

	 WARNING
	<p>Only use the proper power cable that is permitted in your country. Be sure to use the correct plug shape (refer to).</p>

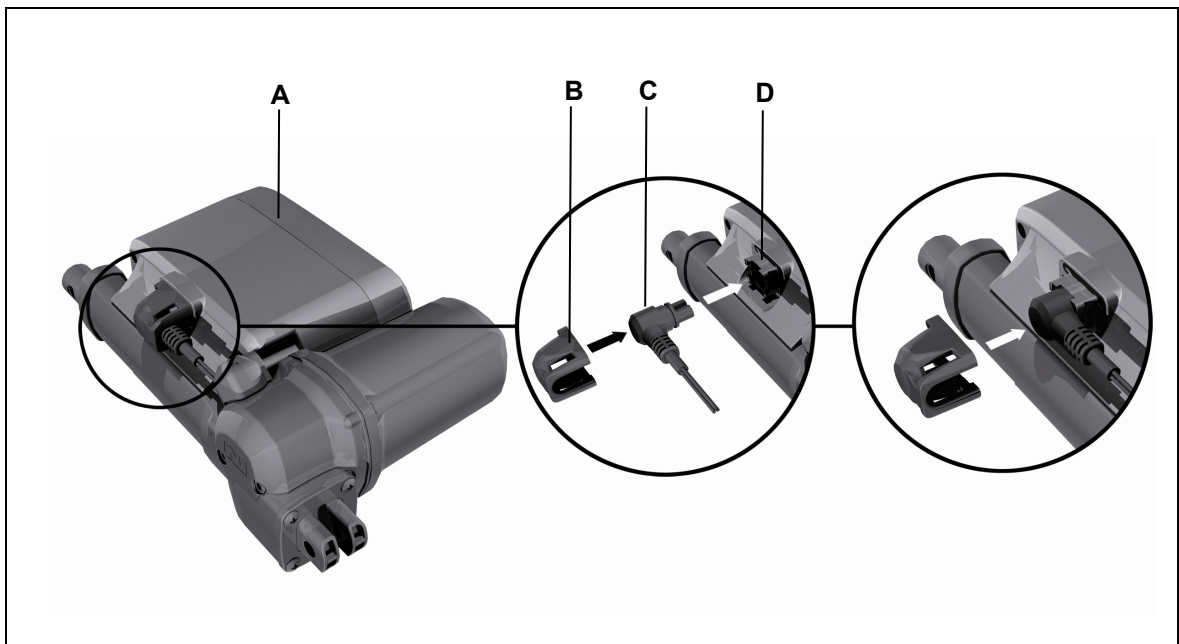

Figure 11 Connecting the pluggable power cord to the MC11 control unit

A MC11 control unit



B Snap-on cap

C Power plug

D Power socket on the MC11 control unit

The pluggable power cord should be attached to the power socket (D) located on the rear of the control unit.

- 1 Pull out the mains plug from the outlet.

	 CAUTION
	You should only connect and disconnect the cables when they are completely disconnected from any live current!



- 2 Remove the cap (B) from the socket.
- 2 Plug the power plug from the power cord (C) into the socket.
- 3 Push the cap (B) onto the inserted plug until you hear the cap snap on.

After plugging the power plug into the power outlet,

	NOTICE
	There is a delay after the supply voltage is applied before the device actually turns on. Wait at least 2 seconds before the initial commissioning.

6.2.4 Disconnecting the MC11 control unit

- 1 Pull out the mains plug from the outlet.

	 CAUTION
	You should only connect and disconnect the cables when they are completely disconnected from any live current!

- 2 Open and remove the shield cover (refer to Figure 10).
- 2 Disconnect all connecting cables from the MC11 control unit.
- 3 Unscrew the screw, as shown in Figure 9.
- 4 Remove the MC11 control unit from the drive.

6.2.5 Connecting the optional battery

An external rechargeable battery can be connected to the optional battery socket. The sticker above the sockets shows the position of the battery socket (refer to the "Layout of system connections" section in the "Combination Possibilities" Chapter).

- 1 Pull out the mains plug from the outlet.
- 2 Use a suitable tool to press the three locking clips down into the notches as shown in Figure 10. At the same time, tilt the shield cover forward so that the clips come out of the notches.
- 2 Remove the shield cover.
- 3 Insert the battery plug into the battery socket on the MC11 control unit. Be sure to use the proper socket (the assignments of plugs to sockets in shown in the connection layout diagram). Figure 2 in the "Combination Possibilities" Chapter shows the connection positions.
- 4 Push the shield cover on until the locking clips snap into the notches.

6.2.6 Connecting the optional, additional Supervisor or Control Box

The Supervisor or the Control Box can be connected to the optional Supervisor socket. The sticker above the Supervisor socket shows the position of the socket (refer to the "Layout of system connections" section in the "Combination Possibilities" Chapter).

- 1 Pull out the mains plug from the outlet.
- 2 Use a suitable tool to press the three locking clips down into the notches as shown in Figure 10. At the same time, tilt the shield cover forward so that the clips come out of the notches.
- 2 Remove the shield cover.
- 3 Insert the Supervisor, Control Box or short-circuit plug in the Supervisor socket of the MC11 control unit. Be sure to use the proper socket (the assignments of plugs to sockets in shown in the connection layout diagram). Figure 2 in the "Combination Possibilities" Chapter shows the connection positions.
- 4 Push the shield cover on until the locking clips snap into the notches.

6.2.7 Optional: Mounting the control unit with the adapter

Mounting the adapter on the control unit

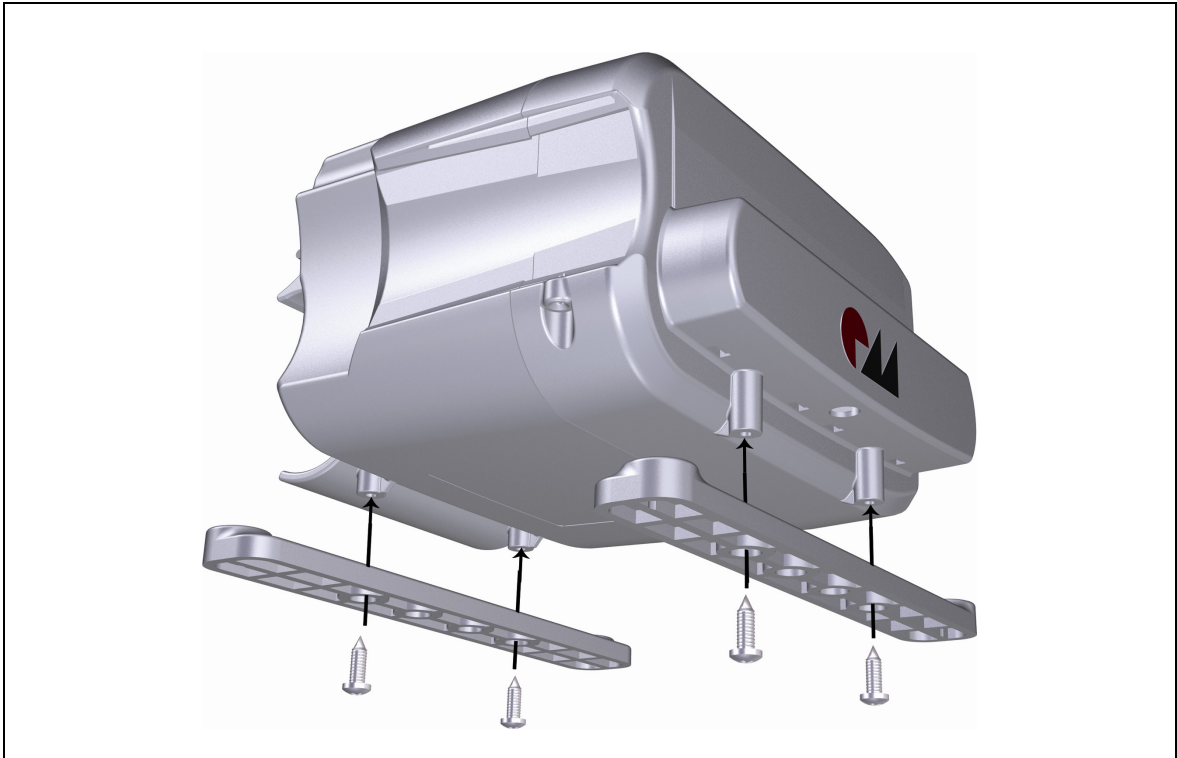



Figure 12 Mounting the adapter on the MC11 control unit

- 1 Mount the optional adapter to the control unit using four screws (according to DIN 7981: 3.9 mm diam. and 13 mm length), as shown in Figure 12.

Mounting to the end product

The MC11 control unit is screwed onto the end product by using four screws for the four mounting points (e.g. DIN 7981 screws with 4.8 mm diameter and suitable length of 6 mm plus screw-in depth).

NOTICE	
	<p>Observe the following while mounting to the end product:</p> <ul style="list-style-type: none"> • The MC 11 control unit should be mounted so that it lies against its supporting material. • No mechanical forces or torsion should be exerted on it by the end product. Such forces could lead to damage (such as cracks).

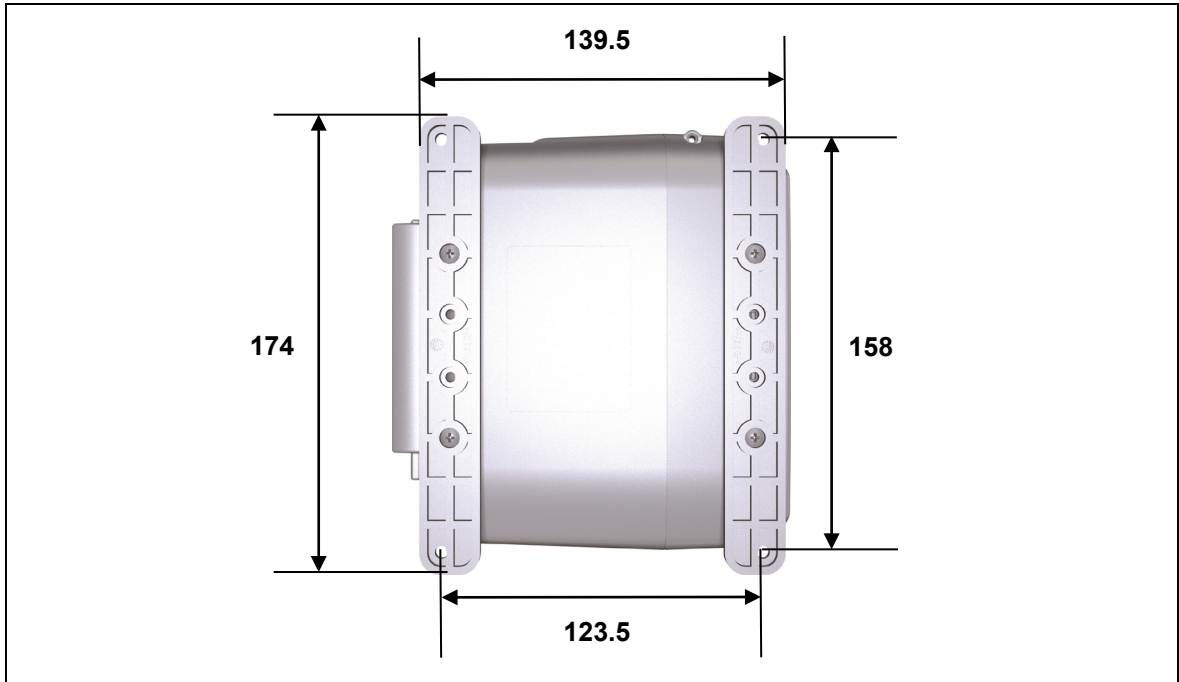

Figure 13 Mounting dimensions of the holes. View from below (in mm)

- 1 The control unit is screwed onto the end product by using four screws for the four mounting points (e.g. DIN 7981 screws with 4.8 mm diameter and suitable length of 6 mm plus screw-in depth) as shown in Figure 14. The mounting dimensions are shown in Figure 13.

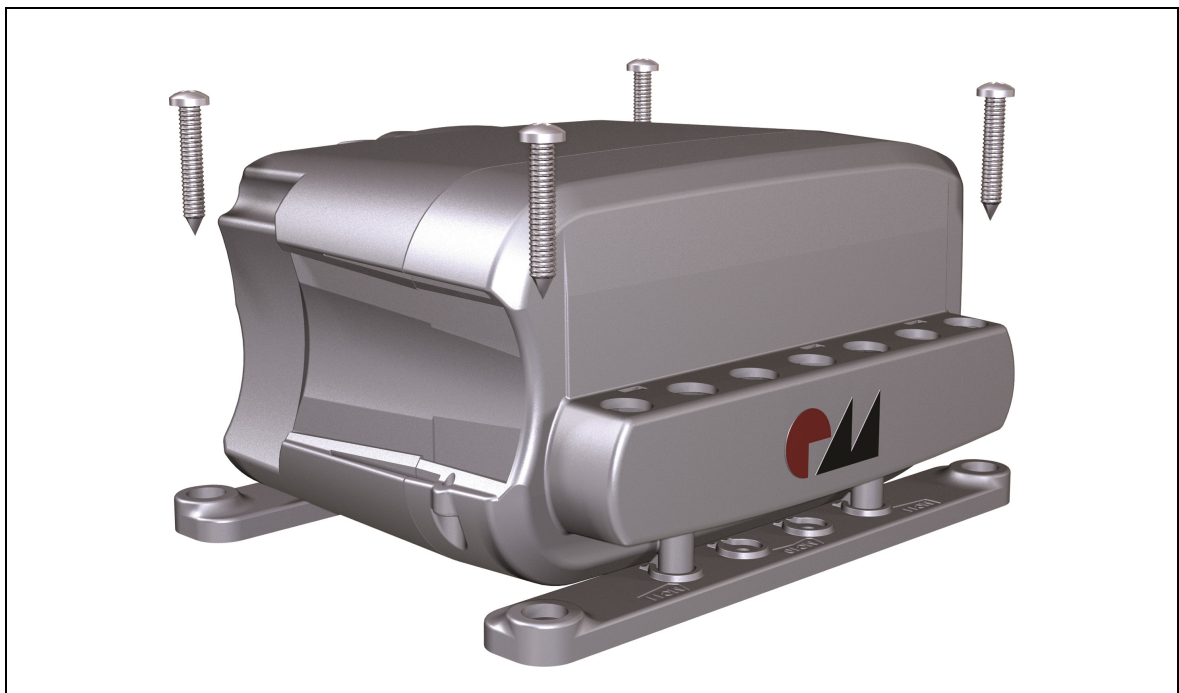



Figure 14 Attaching the MC11 control unit to the end product

7. Operating notes

The factual information contained within may be used when you are creating the end-product manual. The installation instructions do not contain all information required for the safe operation of the end product. They only describe the assembly and operation of the MC11 control unit as a partially assembled piece of machinery.

	 CAUTION
	When creating the operating instructions, remember that the installation instructions are intended for qualified specialists and are not for typical users of the end product.

7.1 General information

- ▶ Only drives from DewertOkin should be connected to the MC11 control unit since they have already been verified to work together.

Delayed start-up

After plugging the power plug into the power outlet,

	NOTICE
	There is a delay after the supply voltage is applied before the device actually turns on. Wait at least 2 seconds before the initial commissioning.

Power-on time / intermittent operations

The MC11 control unit has been designed for intermittent operations. Intermittent operation is an operational mode where the drive must pause after a specified maximum period of operation (power-on time). This protects the drive from overheating. Extreme overheating can cause a malfunction.



- ▶ The ratings plate specifies the maximum power-on time and the required pause intervals.

Avoiding toggle operations



You should avoid switching from one direction of travel to the opposite direction without first stopping the motor. Make sure that you pause between motions! A pause (motor stop time) can be activated using the controls.



	NOTICE
	You should always avoid a quick change (toggling) of directions.

Avoiding electrical risks



	 WARNING
	<p>Make sure that all live (current-carrying) parts of the drive system and power supply cannot be touched. In particular, be sure that unused power and control unit connections are covered adequately.</p>

Power cable

	 WARNING
	<p>Please follow these operating instructions carefully. You could be injured by fire or electrical shock if you do not follow these assembly instructions.</p>

	 WARNING
	<p>Only use the proper power cable that is permitted in your country. Be sure to use the correct plug shape (refer to).</p>



Reducing the risk of overheating with the thermal monitor

	 CAUTION
	<p>The MC11 control unit is equipped with a thermal monitoring mechanism that triggers when the unit overheats. If the temperature control has triggered, remove the control unit from the power supply, allow it to rest for 20 to 30 minutes and try again. If the control unit still does not function, please contact your supplier or sales agent.</p>

Avoiding overheating



	NOTICE
	<p>No more than two drives may be operated at rated load simultaneously!</p>

Emergency shut off of a connected drive or control unit

	<p data-bbox="395 421 1444 479"> CAUTION</p> <p data-bbox="395 495 1444 589">In an emergency, disconnect the MC11 control unit's power plug in order to shut off the connected drive. The power plug must always be accessible during operations so that it is possible to shut down the drive or control unit at any time.</p> <p data-bbox="395 600 1444 669">If the optional battery is connected, disconnect the battery plug from the socket on the MC11 control unit.</p>
---	---

Avoiding cable damage

Be sure that your operating instructions inform the user about the possible cable risks.

	<p data-bbox="395 898 1444 956"> CAUTION</p> <p data-bbox="395 972 1444 1072">The cables (particularly the connecting cable) should not be run over. In order to prevent injuries or damage to the drive and MC11 control unit, no mechanical strain should be placed on the cables.</p>
--	--

7.2 Notice for operating with optional configuration

7.2.1 Optional: Rechargeable battery with no integrated charging circuitry

If you have purchased an MC11 with no integrated charging circuitry then note the information below when operating with the optional external battery:

- Load the battery for at least 24 hours before first use.
- Use a suitable DewertOkin charger to charge the battery. Follow the instructions that come with the battery charger!
- The battery charge status is displayed on the handset when the handset is equipped with a battery display:
 - The battery is being loaded when the battery control light is blinking.
 - The battery is ready when the unit is plugged into the mains and the battery control light is continuously illuminated.
- After you have used the battery-operated reset function, be sure to charge the battery until the ready signal is displayed (the battery control light, when present, stays illuminated).
- ▶ Follow the additional information found in the rechargeable battery information sheet (ID No. 45564).



7.2.2 Optional: rechargeable battery with integrated charging circuitry

If you have purchased the MC11 with the integrated charging circuitry and external battery, then you should note the following:

- Load the battery for at least 24 hours before first use.
- The battery charge status is displayed on the handset when the handset is equipped with a battery display:
 - The battery is being loaded when the battery control light is blinking.
 - The battery is ready when the unit is plugged into the mains and the battery control light is continuously illuminated.
- Optional: A warning tone is issued when the battery charge is low. Shortly after the tone, the battery is switched off so that it cannot be damaged by a drain discharge.
- After you have used the battery-operated reset function, be sure to charge the battery until the ready signal is displayed (the battery control light, when present, stays illuminated). The integrated charging circuitry in the MC11 control unit controls the charge automatically.
- ▶ Follow the additional information found in the rechargeable battery information sheet (ID No. 45564).

8. Troubleshooting

This chapter describes troubleshooting methods for fixing problems. If you experience an error that is not listed in this table, please contact your supplier.

	 CAUTION
	<p>Only qualified specialists who have received electrician training should carry out troubleshooting and repairs.</p>

Problem	Possible cause	Solution
The drive or control unit is not functioning.	There is no mains supply voltage.	Connect the mains power.
	The drive or control unit is defective.	Please contact your supplier or sales agent.
The drive is suddenly not capable of movement.	The overheating protection or system protection has been triggered.	Remove the overload (change or remove the load). Allow the system to rest for 20 to 30 minutes with the mains power unplugged. If this does not resolve the problem, contact your supplier or distributor.
	The unit's fuse may have been triggered.	Please contact your supplier or sales agent.
	There is no mains supply voltage.	Connect the mains power.
	A lead-in connection has been interrupted (mains power, auxiliary drive or handset).	Check the cables and reinsert them, if required.

9. Maintenance

- ▶ You should only use spare parts which have been manufactured or approved by DewertOkin. Only these parts will guarantee a sufficient level of safety.

9.1 Maintenance



Type of check	Explanation	Time interval
Check the function and safety of the electrical system.	A qualified electrician should carry out this inspection. (Refer to the "Electrical connection" section in the "Installation" Chapter.)	Periodic inspections can be carried out at intervals based on the risk assessment which you conduct for your end product.
Look over the housing periodically for any signs of damage.	Check the housing for breaks or cracks.	At least every six months.
Look over the plug-in connections and electrical access points for signs of damage.	Check that all electrical cables and connections are firmly seated and correctly positioned.	At least every six months.
Look over the cables for any signs of damage.	Check the connecting cables for pinching or shearing. Also check the strain relief and kink protection mechanisms, in particular after any mechanical load.	At least every six months.
Check periodically to see if the rechargeable battery is ready and operational. (Battery is optional)	If you can no longer move the drive in both directions with a fully charged battery, then you should replace the battery.	At least every four weeks.

9.2 Cleaning and care

The MC11 control unit was designed so that it would be easy to clean. Its smooth surfaces simplify the cleaning process.

	NOTICE
	Never clean the MC11 control unit in an automated washing system or with a high-pressure cleaner. Do not allow fluids to penetrate the lighting. Damage to the system could result.

- 1 Be sure to unplug the power cord on the MC11 control unit before you begin cleaning it!

	 CAUTION
	For the optional rechargeable battery: Disconnect the battery plug from the socket on the MC11 control unit.

- 2 Clean the MC11 control unit with a dry cloth.
- 3 Be sure that you do not damage the connecting cables during the cleaning.

	NOTICE
	Do not use a cleanser that contains benzene, alcohol or similar solvents.

10. Disposal

10.1 Packaging material

The packaging material should be sorted into recyclable components and then disposed of in accordance with the appropriate national environmental regulations (in Germany according to the recycling law KrWG from 01.06.2012; internationally according to the EU Directive 2008/98/EC (Waste Framework Directive WFD as of 12.12.2008)).

10.2 Components in the control unit

The MC11 control unit consists of electronic components, cables and metal and plastic parts. You should observe all corresponding national and regional environmental regulations when disposing of the MC11 control unit.

The disposal of the product is regulated in Germany by Elektro-G, internationally by the EU Directive 2012/19/EC (WEEE), or by any applicable national laws and regulations.



The MC11 control unit should not be disposed of with normal household waste!

The disposal of the rechargeable battery is regulated in the EU by the Battery Directive 2006/66/EC, in Germany by the BattG battery law of 25.6.2009, and internationally by any applicable national laws and regulations.



This battery should not be disposed of with normal household waste!

EG-Konformitätserklärung

Nach Anhang IV der EMV-Richtlinie 2014/30/EU

Nach Anhang IV der EU-Niederspannungsrichtlinie 2014/35/EU

Nach Anhang VI der RoHS-Richtlinie 2011/65/EU (inkl. Delegierte Richtlinie (EU) 2015/863)

Der Hersteller

EU Declaration of Conformity

In compliance with Appendix IV of the EMC-Directive 2014/30/EU

In compliance with Appendix IV of the LVD-Directive 2014/35/EU

In compliance with Appendix VI of the EU RoHS Directive 2011/65/EU (incl. Commission delegated Directive (EU) 2015/863)

The manufacturer

DewertOkin GmbH
Weststraße 1
32278 Kirchlengern
Deutschland - Germany

erklärt hiermit, dass das Produkt

declares that the following product

MC11

die Anforderungen folgender EG-Richtlinien erfüllt:

meets the requirements of the following EU directives:

Richtlinie über elektromagnetische Verträglichkeit 2014/30/EU

Electromagnetic Compatibility Directive 2014/30/EU

Niederspannungsrichtlinie 2014/35/EU

Low Voltage Directive 2014/35/EU

DELEGIERTE RICHTLINIE (EU) 2015/863 DER KOMMISSION vom 31. März 2015 zur Änderung von Anhang II der Richtlinie 2011/65/EU des Europäischen Parlaments und des Rates hinsichtlich der Liste der Stoffe, die Beschränkungen unterliegen.

COMMISSION DELEGATED DIRECTIVE (EU) 2015/863 of 31 March 2015 amending Annex II to Directive 2011/65/EU of the European Parliament and of the Council as regards the list of restricted substances.

Angewendete Normen

Applied standards:

- EN 60335-1:2012/A11:2014
- EN 55014-1:2006/A1:2009/A2:2011
- EN 55014-2:1997/A1:2001/A2:2008
- EN 61000-3-2:2014
- EN 61000-3-3:2013
- EN 62233:2008

Konstruktive Änderungen, die Auswirkungen auf die in der Montageanleitung angegebenen technischen Daten und den bestimmungsgemäßen Gebrauch haben, das Produkt also wesentlich verändern, machen diese Konformitätserklärung ungültig!

This declaration of conformity is no longer valid if constructional changes are made which significantly change the drive system (i.e., which influence the technical specifications found in the instructions or the intended use)!

Kirchlengern, Germany 25 February 2020



Dr.-Ing. Josef G. Groß
Geschäftsführer / Managing Director

Additional information

MC11 control unit

For the models with IPX4 protection or greater, in conformity with:

- EN 60601-1:2006 + A1:2013, IEC 60601-1:2005 + A1:2012 (shortened: Edition 3.1), Medical Electrical Devices
- EN 60601-1-2:2015, IEC 60601-1-2:2014 (shortened: Edition 4.0), EMC

The following standards have been applied:

IEC/EN 60601-1, section 4	General requirements
IEC/EN 60601-1, section 6	Classification
IEC/EN 60601-1, section 7.1	Labelling – general
IEC/EN 60601-1, section 7.2	Labelling – inscriptions
IEC/EN 60601-1, section 8	Protection against electrical danger, leakage currents
IEC/EN 60601-1, section 11.1	Overheating protection
IEC/EN 60601-1, section 11.2	Fire prevention
IEC/EN 60601-1, section 11.3	Design requirements for fire-resistant housing
IEC/EN 60601-1, section 13	Dangerous situations and error conditions
IEC/EN 60601-1, section 15.3	Mechanical attachment
IEC/EN 60601-1, section 15.4	Components and general construction
IEC/EN 60601-1, section 17	Electromagnetic compatibility

Additional information

MC11 control unit

For the models with IPX4 protection or greater, in conformity with:

- EN 60601-2-52, IEC 60601-2-52, (special requirements for the safety, including essential performance characteristics, of medical beds)

The following standards have been applied:

IEC/EN 60601-2-52, Section 201.6.2	Protection against electrical shock: Protection class: II
IEC/EN 60601-2-52, Section 201.7.6.3	Control panel symbols (depending on model, customer requirements)
IEC/EN 60601-2-52, Section 201.8.11.3.2	EPR power supply cable: only for ≥ 2.5 m length
IEC/EN 60601-2-52, Section 201.9.2.2.5	Continuous operations: Control keypad only with keys
IEC/EN 60601-2-52, Section 201.9.2.3.1	Unintentional movement: Prevented by means of a locking mechanism (such as Control box, Supervisor, IPROXX [®] SE, IPROXX [®] , or Meditouch)
IEC/EN 60601-2-52, Section 201.9.6.2.1	Noise level: ≤ 65 dB(A)
IEC/EN 60601-2-52, Section 201.11.1.1	Temperature
IEC/EN 60601-2-52, Section 201.11.6.5.101	Protection against water ingress: only for \geq IPX4
IEC/EN 60601-2-52, Section 201.11.8	Loss of power (e.g. using a battery rechargeable battery), depending on customer requirements
IEC/EN 60601-2-52, Section 201.13.1.4	Special mechanical risks, depending on customer requirements: Prevented by means of a locking mechanism (such as Control box, Supervisor, IPROXX [®] SE, IPROXX [®] , or Meditouch)
IEC/EN 60601-2-52, Section 201.15.3.4.1	Mechanical strength – handset (e.g. IPROXX [®])
IEC/EN 60601-2-52, Section 201.15.4.4	Displays: Ready indicator is not required
IEC/EN 60601-2-52, Section BB.3.3.3	Dimensions (depending on version and customer requirements) – handset (e.g. IPROXX [®])
IEC/EN 60601-2-52, Section BB.3.4.1	Operational forces – handset (e.g. IPROXX [®])

DewertOkin GmbH
Weststrasse 1
Kirchlengern 32278, Germany
Tel: +49 (0)5223/979-0
Fax.: +49 (0)5223/75182
<http://www.dewertokin.de>
Info@dewertokin.de

ID No.: 66650